

**STATE OF LIBYA  
GOVERNMENT OF LIBYA  
MINISTRY OF TRANSPORT  
CIVIL AVIATION AUTHORITY**



**دولة ليبيا  
الحكومة الليبية  
وزارة المواصلات  
مصلحة الطيران المدني**

# **LIBYA CIVIL AVIATION REGULATIONS Air Operations**

AMC (Acceptable Means of Compliance) & GM (Guidance Material)

## **Part CAT Commercial Air Transport**

Amendment 1 – August 2016

INTENTIONALLY LEFT BLANK

## INTRODUCTION

1. The LYCAA has adopted associated compliance or interpretative material to Part ORO. This document is based on EASA Acceptable Means of Compliance (AMCs) and Guidance Materials (GMs).
2. This is Amendment 1 to AMC & GM to LYCARs – Air Operations Part CAT.
3. Unless specifically stated otherwise, clarification will be based on this material or other EASA documentation, therefore, reference to EASA in this document may still be used for clarification and guidance.
4. The information contained herein is subject to constant review in the light of changing regulations and requirements. No subscriber or other reader should act on the basis of any such information without also referring to the applicable laws and regulations and/or without taking appropriate professional advice when/as indicated/required. Although, every effort has been made to ensure accuracy, the Libyan Civil Aviation Authority, shall not be held responsible for loss or damage caused by errors, omissions, misprints or misinterpretation of the contents hereof.
5. Copies of this publication can be obtained from the following address:  
Flight Safety Department  
Civil Aviation Authority  
Or downloaded from: [www.caa.gov.ly](http://www.caa.gov.ly)

Signed on 30 August 2016, by

**Captain Nasereddin Shaebelain**  
**Director General**

INTENTIONALLY LEFT BLANK

## TABLE OF CONTENT

<b>SUBPART A — GENERAL REQUIREMENTS</b> .....	<b>1</b>
<b>SECTION I — MOTOR-POWERED AIRCRAFT</b> .....	<b>1</b>
AMC1 CAT.GEN.MPA.100(b) Crew responsibilities .....	1
AMC1 CAT.GEN.MPA.100(c)(1) Crew responsibilities .....	1
GM1 CAT.GEN.MPA.100(c)(2) Crew responsibilities .....	1
AMC1 CAT.GEN.MPA.115(a) Personnel or crew members other than cabin crew in the passenger compartment .....	1
GM1 CAT.GEN.MPA.115 Personnel or crew members other than cabin crew in the passenger compartment.....	1
GM1 CAT.GEN.MPA.125 Taxiing of aeroplanes .....	2
GM1 CAT.GEN.MPA.130 Rotor engagement— helicopters .....	3
AMC1 CAT.GEN.MPA.135(a)(3) Admission to the flight crew compartment .....	3
AMC1 CAT.GEN.MPA.140 Portable electronic devices .....	3
AMC2 CAT.GEN.MPA.140 Portable electronic devices.....	8
GM1 CAT.GEN.MPA.140 Portable electronic devices .....	10
GM2 CAT.GEN.MPA.140 Portable electronic devices.....	11
GM3 CAT.GEN.MPA.140 Portable electronic devices .....	11
AMC1 CAT.GEN.MPA.145 Information on emergency and survival equipment carried	12
GM1 CAT.GEN.MPA.155 Carriage of weapons of war and munitions of war .....	12
GM1 CAT.GEN.MPA.160 Carriage of sporting weapons and ammunition .....	12
AMC1 CAT.GEN.MPA.161 Carriage of sporting weapons and ammunition — alleviations.....	13
AMC1 CAT.GEN.MPA.180 Documents, manuals and information to be carried.....	13
GM1 CAT.GEN.MPA.180(a)(1) Documents, manuals and information to be carried .....	13
GM1 CAT.GEN.MPA.180(a)(5)(6) Documents, manuals and information to be carried...13	13
GM1 CAT.GEN.MPA.180(a)(9) Documents, manuals and information to be carried .....	13
AMC1 CAT.GEN.MPA.180(a)(13) Documents, manuals and information to be carried .....	14
GM1 CAT.GEN.MPA.180(a)(14) Documents, manuals and information to be carried	14
GM1 CAT.GEN.MPA.180(a)(23) Documents, manuals and information to be carried .....	14
GM1 CAT.GEN.MPA.195(a) Preservation, production and use of flight recorder recordings.....	14
AMC1 CAT.GEN.MPA.195(b) Preservation, production and use of flight recorder recordings.....	14
GM1 CAT.GEN.MPA.195(b) Preservation, production and use of flight recorder recordings.....	15
AMC1 CAT.GEN.MPA.200(e) Transport of dangerous goods.....	17
GM1 CAT.GEN.MPA.200 Transport of dangerous goods .....	20
<b>SECTION 2 — NON-MOTOR-POWERED AIRCRAFT</b> .....	<b>22</b>
AMC1 CAT.GEN.NMPA.100(b)(1) Responsibilities of the commander .. <b>Error! Bookmark not defined.</b>	

GM1 CAT.GEN.NMPA.100(b)(2) Responsibilities of the commander	<b>Error! Bookmark not defined.</b>
GM1 CAT.GEN.NMPA.100(d)(3) Responsibilities of the commander ....	<b>Error! Bookmark not defined.</b>
AMC1 CAT.GEN.NMPA.105(a) Additional balloon crew member .....	<b>Error! Bookmark not defined.</b>
AMC1 CAT.GEN.NMPA.105(b)(1) Additional balloon crew member .	<b>Error! Bookmark not defined.</b>
GM1 CAT.GEN.NMPA.105(b)(2) Additional balloon crew member...	<b>Error! Bookmark not defined.</b>
GM1 CAT.GEN.NMPA.120 Portable electronic devices .....	<b>Error! Bookmark not defined.</b>
AMC1 CAT.GEN.NMPA.125 Information on emergency and survival equipment carried .....	<b>Error! Bookmark not defined.</b>
GM1 CAT.GEN.NMPA.140 Documents, manuals and information to be carried .....	<b>Error! Bookmark not defined.</b>
GM1 CAT.GEN.NMPA.140(a)(1) Documents, manuals and information to be carried .....	<b>Error! Bookmark not defined.</b>
GM1 CAT.GEN.NMPA.140(a)(5)(6) Documents, manuals and information to be carried .....	<b>Error! Bookmark not defined.</b>
GM1 CAT.GEN.NMPA.140(a)(9) Documents, manuals and information to be carried .....	<b>Error! Bookmark not defined.</b>
AMC1 CAT.GEN.NMPA.140(a)(13) Documents, manuals and information to be carried .....	<b>Error! Bookmark not defined.</b>
AMC1 CAT.GEN.NMPA.140(a)(14) Documents, manuals and information to be carried .....	<b>Error! Bookmark not defined.</b>
GM1 CAT.GEN.NMPA.140(a)(15) Documents, manuals and information to be carried .....	<b>Error! Bookmark not defined.</b>
GM1 CAT.GEN.NMPA.140(a)(21) Documents, manuals and information to be carried .....	<b>Error! Bookmark not defined.</b>
GM1 CAT.GEN.NMPA.150(a)(1) Transport of dangerous goods .....	<b>Error! Bookmark not defined.</b>
GM1 CAT.GEN.NMPA.150(a)(2) Transport of dangerous goods .....	<b>Error! Bookmark not defined.</b>
GM1 CAT.GEN.NMPA.150(b)(c) Transport of dangerous goods....	<b>Error! Bookmark not defined.</b>
<b>SUBPART B — OPERATING PROCEDURES.....</b>	<b>23</b>
<b>SECTION 1 — MOTOR-POWERED AIRCRAFT.....</b>	<b>23</b>
GM1 CAT.OP.MPA.100(a)(2) Use of air traffic services.....	23
AMC1 CAT.OP.MPA.105 Use of aerodromes and operating sites.....	23
AMC2 CAT.OP.MPA.105 Use of aerodromes and operating sites .....	23
AMC1 CAT.OP.MPA.110 Aerodrome operating minima .....	28
AMC2 CAT.OP.MPA.110 Aerodrome operating minima .....	29
AMC3 CAT.OP.MPA.110 Aerodrome operating minima .....	31
AMC4 CAT.OP.MPA.110 Aerodrome operating minima .....	32
AMC5 CAT.OP.MPA.110 Aerodrome operating minima .....	33
AMC6 CAT.OP.MPA.110 Aerodrome operating minima .....	37
AMC7 CAT.OP.MPA.110 Aerodrome operating minima .....	39
AMC8 CAT.OP.MPA.110 Aerodrome operating minima .....	43

AMC9 CAT.OP.MPA.110 Aerodrome operating minima .....	43
AMC10 CAT.OP.MPA.110 Aerodrome operating minima .....	43
AMC11 CAT.OP.MPA.110 Aerodrome operating minima .....	43
AMC12 CAT.OP.MPA.110 Aerodrome operating minima .....	45
GM1 CAT.OP.MPA.110 Aerodrome operating minima .....	45
GM2 CAT.OP.MPA.110 Aerodrome operating minima .....	45
GM3 CAT.OP.MPA.110 Aerodrome operating minima .....	46
GM1 CAT.OP.MPA.110(a) Aerodrome operating minima .....	46
AMC1 CAT.OP.MPA.115 Approach flight technique — aeroplanes.....	46
AMC2 CAT.OP.MPA.115 Approach flight technique — aeroplanes .....	48
AMC3 CAT.OP.MPA.115 Approach flight technique — aeroplanes .....	49
GM1 CAT.OP.MPA.115 Approach flight technique — aeroplanes .....	51
AMC1 CAT.OP.MPA.120 Airborne radar approaches (ARAs) for overwater operations — helicopters .....	52
GM1 CAT.OP.MPA.120 Airborne radar approaches (ARAs) for overwater operations — helicopters .....	53
AMC1 CAT.OP.MPA.130 Noise abatement procedures — aeroplanes .....	59
GM1 CAT.OP.MPA.130 Noise abatement procedures — aeroplanes .....	63
GM1 CAT.OP.MPA.137(b) Routes and areas of operation — helicopters .....	64
AMC1 CAT.OP.MPA.140(c) Maximum distance from an adequate aerodrome for two- engined aeroplanes without an ETOPS approval .....	67
GM1 CAT.OP.MPA.140(c) Maximum distance from an adequate aerodrome for two- engined aeroplanes without an ETOPS approval .....	70
AMC1 CAT.OP.MPA.145(a) Establishment of minimum flight altitudes.....	70
AMC1.1 CAT.OP.MPA.145(a) Establishment of minimum flight altitudes.....	71
GM1 CAT.OP.MPA.145(a) Establishment of minimum flight altitudes .....	71
AMC1 CAT.OP.MPA.150(b) Fuel policy .....	75
AMC2 CAT.OP.MPA.150(b) Fuel policy.....	78
AMC3 CAT.OP.MPA.150(b) Fuel policy.....	79
GM1 CAT.OP.MPA.150(b) Fuel policy .....	81
GM1 CAT.OP.MPA.150(c)(3)(i) Fuel policy.....	81
GM1 CAT.OP.MPA.150(c)(3)(ii) Fuel policy .....	81
AMC1 CAT.OP.MPA.155(b) Carriage of special categories of passengers (SCPs).....	81
AMC1 CAT.OP.MPA.160 Stowage of baggage and cargo .....	85
AMC2 CAT.OP.MPA.160 Stowage of baggage and cargo .....	86
AMC1 CAT.OP.MPA.165 Passenger seating.....	86
AMC2 CAT.OP.MPA.165 Passenger seating.....	86
GM1 CAT.OP.MPA.165 Passenger seating .....	87
AMC1 CAT.OP.MPA.170 Passenger briefing .....	87
AMC1.1 CAT.OP.MPA.170 Passenger briefing.....	88
AMC2 CAT.OP.MPA.170 Passenger briefing.....	88
AMC1 CAT.OP.MPA.175(a) Flight preparation.....	89
AMC1 CAT.OP.MPA.181(b)(1) Selection of aerodromes and operating sites — helicopters .....	90
GM1 CAT.OP.MPA.181 Selection of aerodromes and operating sites — helicopters ...	91

AMC1 CAT.OP.MPA.181(d) Selection of aerodromes and operating sites — helicopters .....	92
GM1 CAT.OP.MPA.185 Planning minima for IFR flights — aeroplanes .....	94
GM2 CAT.OP.MPA.185 Planning minima for IFR flights — aeroplanes .....	94
GM1 CAT.OP.MPA.186 Planning minima for IFR flights — helicopters.....	96
AMC1 CAT.OP.MPA.190 Submission of the ATS flight plan.....	96
AMC1 CAT.OP.MPA.195 Refuelling/defuelling with passengers embarking, on board or disembarking .....	96
GM1 CAT.OP.MPA.200 Refuelling/defuelling with wide-cut fuel .....	97
AMC1 CAT.OP.MPA.205 Pushback and towing — aeroplanes .....	98
AMC1 CAT.OP.MPA.210(b) Crew members at stations .....	98
GM1 CAT.OP.MPA.210 Crew members at stations.....	99
GM1 CAT.OP.MPA.250 Ice and other contaminants — ground procedures.....	100
GM2 CAT.OP.MPA.250 Ice and other contaminants — ground procedures.....	102
GM3 CAT.OP.MPA.250 Ice and other contaminants — ground procedures.....	105
AMC1 CAT.OP.MPA.255 Ice and other contaminants — flight procedures .....	107
AMC2 CAT.OP.MPA.255 Ice and other contaminants — flight procedures .....	108
AMC1 CAT.OP.MPA.281 In-flight fuel management — helicopters .....	109
GM1 CAT.OP.MPA.290 Ground proximity detection .....	110
GM1 CAT.OP.MPA.295 Use of airborne collision avoidance system (ACAS) .....	116
AMC1 CAT.OP.MPA.300 Approach and landing conditions .....	125
AMC1 CAT.OP.MPA.305(e) Commencement and continuation of approach .....	125
GM1 CAT.OP.MPA.305(f) Commencement and continuation of approach.....	127
GM1 CAT.OP.MPA.315 Flight hours reporting — helicopters .....	127
<b>SECTION 2 — NON-MOTOR-POWERED AIRCRAFT.....</b>	<b>128</b>
GM1 CAT.OP.NMPA.100 Use of aerodromes and operating sites..... <b>Error! Bookmark not defined.</b>	
AMC1 CAT.OP.NMPA.115 Carriage of special categories of passengers (SCPs)... <b>Error! Bookmark not defined.</b>	
AMC1 CAT.OP.NMPA.120 Passenger briefing..... <b>Error! Bookmark not defined.</b>	
AMC2 CAT.OP.NMPA.120 Passenger briefing .....	<b>Error! Bookmark not defined.</b>
AMC1 CAT.OP.NMPA.125(a) Flight preparation .....	<b>Error! Bookmark not defined.</b>
AMC1 CAT.OP.NMPA.130 Submission of the ATS flight plan..... <b>Error! Bookmark not defined.</b>	
AMC1 CAT.OP.NMPA.155 Take-off conditions .....	<b>Error! Bookmark not defined.</b>
GM1 CAT.OP.NMPA.180 Operational limitations — hot-air balloons.... <b>Error! Bookmark not defined.</b>	
<b>SUBPART C — AIRCRAFT PERFORMANCE AND OPERATING LIMITATIONS .....</b>	<b>129</b>
<b>SECTION 1 — AEROPLANES .....</b>	<b>129</b>
<b>CHAPTER 2 — PERFORMANCE CLASS A .....</b>	<b>129</b>
AMC1 CAT.POL.A.200 General.....	129
AMC1 CAT.POL.A.205 Take-off.....	129
GM1 CAT.POL.A.205 Take-off .....	131
AMC1 CAT.POL.A.210 Take-off obstacle clearance .....	131
AMC2 CAT.POL.A.210 Take-off obstacle clearance .....	132
AMC3 CAT.POL.A.210 Take-off obstacle clearance .....	132



GM1 CAT.POL.A.210 Take-off obstacle clearance.....	133
AMC1 CAT.POL.A.215 En-route – one-engine-inoperative (OEI).....	133
AMC1 CAT.POL.A.225 Landing — destination and alternate aerodromes .....	134
AMC2 CAT.POL.A.225 Landing — destination and alternate aerodromes .....	134
GM1 CAT.POL.A.225 Landing — destination and alternate aerodromes .....	134
AMC1 CAT.POL.A.230 Landing — dry runways.....	134
GM1 CAT.POL.A.230 Landing — dry runways .....	135
<b>CHAPTER 3 — PERFORMANCE CLASS B .....</b>	<b>136</b>
AMC1 CAT.POL.A.305 Take-off.....	136
AMC2 CAT.POL.A.305 Take-off.....	136
GM1 CAT.POL.A.305 Take-off .....	136
AMC1 CAT.POL.A.310 Take-off obstacle clearance — multi-engined aeroplanes .....	137
AMC2 CAT.POL.A.310 Take-off obstacle clearance — multi-engined aeroplanes .....	137
GM1 CAT.POL.A.310 Take-off obstacle clearance — multi-engined aeroplanes.....	138
GM2 CAT.POL.A.310 Take-off obstacle clearance — multi-engined aeroplanes.....	138
GM1 CAT.POL.A.315 En-route — multi-engined aeroplanes .....	140
AMC1 CAT.POL.A.320 En-route — single-engined aeroplanes .....	140
GM1 CAT.POL.A.320 En-route — single-engined aeroplanes.....	141
AMC1 CAT.POL.A.325 Landing — destination and alternate aerodromes .....	141
AMC1 CAT.POL.A.330 Landing — dry runways.....	141
AMC2 CAT.POL.A.330 Landing — dry runways.....	141
GM1 CAT.POL.A.330 Landing — dry runways .....	141
GM1 CAT.POL.A.335 Landing — wet and contaminated runways .....	142
<b>CHAPTER 4 — PERFORMANCE CLASS C .....</b>	<b>143</b>
AMC1 CAT.POL.A.400 Take-off.....	143
AMC2 CAT.POL.A.400 Take-off.....	144
GM1 CAT.POL.A.400 Take-off .....	144
AMC1 CAT.POL.A.405 Take-off obstacle clearance .....	144
AMC2 CAT.POL.A.405 Take-off obstacle clearance .....	145
AMC1 CAT.POL.A.415 En-route – OEI .....	146
AMC1 CAT.POL.A.425 Landing — destination and alternate aerodromes .....	146
AMC1 CAT.POL.A.430 Landing — dry runways.....	146
AMC2 CAT.POL.A.430 Landing — dry runways.....	147
GM1 CAT.POL.A.430 Landing — dry runways .....	147
<b>SECTION 2 — HELICOPTERS.....</b>	<b>148</b>
<b>CHAPTER 1 — GENERAL REQUIREMENTS .....</b>	<b>148</b>
GM1 CAT.POL.H.105(c)(3)(ii)(A) General .....	148
GM1 CAT.POL.H.110(a)(2)(i) Obstacle accountability.....	148
<b>CHAPTER 2 — PERFORMANCE CLASS 1.....</b>	<b>149</b>
GM1 CAT.POL.H.200 & CAT.POL.H.300 & CAT.POL.H.400 General.....	149
AMC1 CAT.POL.H.205(b)(4) Take-off .....	150
GM1 CAT.POL.H.205(b)(4) Take-off .....	150
AMC1 CAT.POL.H.205(e) Take-off .....	153
AMC1 CAT.POL.H.205 & CAT.POL.H.220 Take-off and landing.....	154

GM1 CAT.POL.H.205&CAT.POL.H.220 Take-off and landing.....	155
GM1 CAT.POL.H.215(b)(3) En-route — critical engine inoperative .....	156
AMC1 CAT.POL.H.225(a)(5) Helicopter operations to/from a public interest site.....	156
GM1 CAT.POL.H.225 Helicopter operations to/from a public interest site .....	157
GM1 CAT.POL.H.225(a)(6) Helicopter operations to/from a public interest site.....	158
<b>CHAPTER 3 — PERFORMANCE CLASS 2.....</b>	<b>159</b>
GM to Section 2, Chapter 3 performance class 2 .....	159
AMC1 CAT.POL.H.305(b) Helicopter operations without an assured safe forced landing capability .....	174
AMC2 CAT.POL.H.305(b) Helicopter operations without an assured safe forced landing capability .....	176
GM1 CAT.POL.H.305(b) Helicopter operations without an assured safe forced landing capability .....	177
GM1 CAT.POL.H.310(c) & CAT.POL.H.325(c) Take-off and landing.....	177
GM1 CAT.POL.H.310 & CAT.POL.H.325 Take-off and landing.....	180
<b>CHAPTER 4 — PERFORMANCE CLASS 3 .....</b>	<b>185</b>
GM1 CAT.POL.H.400(c) General .....	185
AMC1 CAT.POL.H.420 Helicopter operations over a hostile environment located outside a congested area.....	186
GM1 CAT.POL.H.420 Helicopter operations over a hostile environment located outside a congested area.....	187
GM2 CAT.POL.H.420(a) Helicopter operations over a hostile environment located outside a congested area .....	188
<b>SECTION 3 — MASS AND BALANCE .....</b>	<b>189</b>
<b>CHAPTER 1 — MOTOR-POWERED AIRCRAFT .....</b>	<b>189</b>
AMC1 CAT.POL.MAB.100(b) Mass and balance, loading .....	190
AMC2 CAT.POL.MAB.100(b) Mass and balance, loading .....	191
AMC3 CAT.POL.MAB.100(b) Mass and balance, loading <b>Error! Bookmark not defined.</b>	
AMC1 CAT.POL.MAB.100(d) Mass and balance, loading .....	192
AMC2 CAT.POL.MAB.100(d) Mass and balance, loading .....	192
AMC1 CAT.POL.MAB.100(e) Mass and balance, loading .....	192
AMC2 CAT.POL.MAB.100(e) Mass and balance, loading .....	194
GM1 CAT.POL.MAB.100(e) Mass and balance, loading .....	196
GM2 CAT.POL.MAB.100(e) Mass and Balance, Loading.....	196
GM3 CAT.POL.MAB.100(e) Mass and balance, loading .....	201
GM1 CAT.POL.MAB.100(g) Mass and balance, loading .....	203
GM1 CAT.POL.MAB.100(i) Mass and balance, loading.....	203
AMC1 CAT.POL.MAB.105(a) Mass and balance data and documentation.....	203
AMC1 CAT.POL.MAB.105(b) Mass and balance data and documentation.....	203
AMC1 CAT.POL.MAB.105(c) Mass and balance data and documentation .....	203
AMC2 CAT.POL.MAB.105(c) Mass and balance data and documentation .....	204
GM1 CAT.POL.MAB.105(e) Mass and balance data and documentation.....	204
GM2 CAT.POL.MAB.105(e) Mass and balance data and documentation .....	204
<b>SECTION 4 — SAILPLANES .....</b>	<b>205</b>
<b>SECTION 5 — BALLOONS .....</b>	<b>206</b>
GM1 CAT.POL.B.105 Weighing .....	<b>Error! Bookmark not defined.</b>

AMC1 CAT.POL.B.110(a)(2) System for determining the mass..... **Error! Bookmark not defined.**

AMC2 CAT.POL.B.110(a)(2) System for determining the mass..... **Error! Bookmark not defined.**

AMC1 CAT.POL.B.110(a)(6) System for determining the mass..... **Error! Bookmark not defined.**

GM1 CAT.POL.B.110(a)(6) System for determining the mass..... **Error! Bookmark not defined.**

**SUBPART D — INSTRUMENT, DATA, EQUIPMENT .....207**

**SECTION 1 — AEROPLANES .....207**

GM1 CAT.IDE.A.100(a) Instruments and equipment—general .....207

GM1 CAT.IDE.A.100(b) Instruments and equipment—general.....207

GM1 CAT.IDE.A.100(d) Instruments and equipment—general.....207

GM1 CAT.IDE.A.110 Spare electrical fuses .....207

AMC1 CAT.IDE.A.120 Equipment to clear windshield .....207

AMC1 CAT.IDE.A.125 & CAT.IDE.A.130 Operations under VFR by day & Operations under IFR or at night — flight and navigational instruments and associated equipment.....207

AMC2 CAT.IDE.A.125 Operations under VFR by day — flight and navigational instruments and associated equipment.....208

AMC1 CAT.IDE.A.125(a)(1)(i) & CAT.IDE.A.130(a)(1) Operations under VFR by day & Operations under IFR or at night — flight and navigational instruments and associated equipment .....208

AMC1 CAT.IDE.A.125(a)(1)(ii) & CAT.IDE.A.130(a)(2) Operations under VFR by day & Operations under IFR or at night — flight and navigational instruments and associated equipment .....208

AMC1 CAT.IDE.A.125(a)(1)(iii) & CAT.IDE.A.130(b) Operations under VFR by day & Operations under IFR or at night — flight and navigational instruments and associated equipment .....208

AMC1 CAT.IDE.A.125(a)(1)(iv) & CAT.IDE.A.130(a)(3) Operations under VFR by day & Operations under IFR or at night — flight and navigational instruments and associated equipment .....208

AMC1 CAT.IDE.A.130(a)(5) Operations under IFR or at night — flight and navigational instruments and associated equipment .....209

AMC2 CAT.IDE.A.130(b) Operations under IFR or at night — flight and navigational instruments and associated equipment .....209

AMC1 CAT.IDE.A.125(a)(1)(ix) & CAT.IDE.A.130(a)(8) Operations under VFR by day & operations under IFR or at night — flight and navigational instruments and associated equipment .....209

AMC1 CAT.IDE.A.125(b) & CAT.IDE.A.130(h) Operations under VFR by day & Operations under IFR or at night — flight and navigational instruments and associated equipment .....209

AMC1 CAT.IDE.A.125(c) & CAT.IDE.A.130(d) Operations under VFR by day & Operations under IFR or at night — flight and navigational instruments and associated equipment .....209

AMC1 CAT.IDE.A.130(e) Operations under IFR or at night — flight and navigational instruments and associated equipment .....209

AMC1 CAT.IDE.A.130(i)(5) Operations under IFR or at night — flight and navigational instruments and associated equipment .....209

AMC1 CAT.IDE.A.130(j) Operations under IFR or at night — flight and navigational instruments and associated equipment .....	210
GM1 CAT.IDE.A.125 & CAT.IDE.A.130 Operations under VFR by day & Operations under IFR or at night — flight and navigational instruments and associated equipment .....	210
AMC1 CAT.IDE.A.150 Terrain awareness warning system (TAWS).....	211
GM1 CAT.IDE.A.150 Terrain awareness warning system (TAWS) .....	212
AMC1 CAT.IDE.A.160 Airborne weather detecting equipment .....	212
AMC1 CAT.IDE.A.170 Flight crew interphone system .....	212
AMC1 CAT.IDE.A.175 Crew member interphone system .....	212
AMC1 CAT.IDE.A.180 Public address system .....	213
AMC1 CAT.IDE.A.185 Cockpit voice recorder .....	213
AMC1 CAT.IDE.A.190 Flight data recorder .....	213
AMC2 CAT.IDE.A.190 Flight data recorder .....	220
AMC3 CAT.IDE.A.190 Flight data recorder .....	226
AMC4 CAT.IDE.A.190 Flight data recorder .....	236
AMC5 CAT.IDE.A.190 Flight data recorder .....	239
AMC6 CAT.IDE.A.190 Flight data recorder .....	244
GM1 CAT.IDE.A.190 Flight data recorder.....	246
AMC1 CAT.IDE.A.195 Data link recording.....	247
GM1 CAT.IDE.A.195 Data link recording.....	249
AMC1 CAT.IDE.A.200 Combination recorder .....	250
GM1 CAT.IDE.A.200 Combination recorder .....	251
AMC1 CAT.IDE.A.205 Seats, seat safety belts, restraint systems and child restraint devices.....	251
AMC2 CAT.IDE.A.205 Seats, seat safety belts, restraint systems and child restraint devices.....	253
AMC3 CAT.IDE.A.205 Seats, seat safety belts, restraint systems and child restraint devices.....	253
AMC1 CAT.IDE.A.220 First-aid kit.....	253
AMC2 CAT.IDE.A.220 First-aid kit.....	254
AMC1 CAT.IDE.A.225 Emergency medical kit .....	254
AMC2 CAT.IDE.A.225 Emergency medical kit .....	255
AMC3 CAT.IDE.A.225 Emergency medical kit .....	255
AMC4 CAT.IDE.A.225 Emergency medical kit .....	256
GM1 CAT.IDE.A.230 First-aid oxygen.....	256
AMC1 CAT.IDE.A.235 Supplemental oxygen — pressurised aeroplanes.....	256
AMC2 CAT.IDE.A.235 Supplemental oxygen — pressurised aeroplanes.....	257
AMC1 CAT.IDE.A.235(e) Supplemental oxygen — pressurised aeroplanes.....	257
GM1 CAT.IDE.A.235(b)(1) Supplemental oxygen — pressurised aeroplanes .....	258
AMC1 CAT.IDE.A.240 Supplemental oxygen — non-pressurised aeroplanes.....	258
AMC1 CAT.IDE.A.245 Crew protective breathing equipment .....	258
AMC1 CAT.IDE.A.250 Hand fire extinguishers.....	258
AMC1 CAT.IDE.A.255 Crash axe and crowbar .....	258
AMC1 CAT.IDE.A.260 Marking of break-in points .....	259
AMC1 CAT.IDE.A.270 Megaphones.....	259

AMC1 CAT.IDE.A.280 Emergency locator transmitter (ELT) .....	259
AMC2 CAT.IDE.A.280 Emergency locator transmitter (ELT) .....	259
GM1 CAT.IDE.A.280 Emergency locator transmitter (ELT) .....	260
AMC1 CAT.IDE.A.285 Flight over water .....	260
AMC1 CAT.IDE.A.285(e)(4) & CAT.IDE.A.305(a)(2) Flight over water & Survival equipment .....	260
AMC1 CAT.IDE.A.285(a) Flight over water.....	260
AMC2 CAT.IDE.A.285(a) Flight over water.....	261
GM1 CAT.IDE.A.285(a) Flight over water.....	261
AMC1 CAT.IDE.A.305 Survival equipment.....	261
AMC1 CAT.IDE.A.305(b)(2) Survival equipment .....	261
GM1 CAT.IDE.A.305 Survival equipment .....	261
GM2 CAT.IDE.A.305 Survival equipment .....	261
AMC1 CAT.IDE.A.325 Headset.....	262
GM1 CAT.IDE.A.325 Headset.....	262
AMC1 CAT.IDE.A.345 Communication and navigation equipment for operations under IFR or under VFR over routes not navigated by reference to visual landmarks .....	262
AMC2 CAT.IDE.A.345 Communication and navigation equipment for operations under IFR or under VFR over routes not navigated by reference to visual landmarks .....	262
AMC3 CAT.IDE.A.345 Communication and navigation equipment for operations under IFR or under VFR over routes not navigated by reference to visual landmarks .....	263
AMC4 CAT.IDE.A.345 Communication and navigation equipment for operations under IFR or under VFR over routes not navigated by reference to visual landmarks .....	263
GM1 CAT.IDE.A.345(c) Communication and navigation equipment for operations under IFR or under VFR over routes not navigated by reference to visual landmarks .....	264
GM1 CAT.IDE.A.345 Communication and navigation equipment for operations under IFR or under VFR over routes not navigated by reference to visual landmarks .....	264
AMC1 CAT.IDE.A.350 Transponder .....	264
AMC1 CAT.IDE.A.355 Electronic navigation data management.....	264
GM1 CAT.IDE.A.355 Electronic navigation data management.....	264
<b>SECTION 2 — HELICOPTERS.....</b>	<b>265</b>
GM1 CAT.IDE.H.100(a) Instruments and equipment — general.....	265
GM1 CAT.IDE.H.100(b) Instruments and equipment — general.....	265
GM1 CAT.IDE.H.100(d) Instruments and equipment — general.....	265
AMC1 CAT.IDE.H.125 & CAT.IDE.H.130 Operations under VFR by day & Operations under IFR or at night — flight and navigational instruments and associated equipment and.....	265
AMC1 CAT.IDE.H.125(a)(1)(i) & CAT.IDE.H.130(a)(1) Operations under VFR by day & Operations under IFR or at night — flight and navigational instruments and associated equipment .....	266
AMC1 CAT.IDE.H.125(a)(1)(ii) & CAT.IDE.H.130(a)(2) Operations under VFR by day & Operations under IFR or at night — flight and navigational instruments and associated equipment .....	266
AMC1 CAT.IDE.H.125(a)(1)(iii) & CAT.IDE.H.130(b) Operations under VFR by day & Operations under IFR or at night — flight and navigational instruments and associated equipment .....	266

AMC1 CAT.IDE.H.125(a)(1)(iv) & CAT.IDE.H.130(a)(43) Operations under VFR by day & Operations under IFR or at night — flight and navigational instruments and associated equipment .....	266
AMC1 CAT.IDE.H.125(a)(1)(vii) & CAT.IDE.H.130(a)(8) Operations under VFR by day & Operations under IFR or at night — flight and navigational instruments and associated equipment .....	266
AMC1 CAT.IDE.H.125(b) & CAT.IDE.H.130(h) Operations under VFR by day & Operations under IFR or at night — flight and navigational instruments and associated equipment and .....	266
AMC1 CAT.IDE.H.125(c)(2) & CAT.IDE.H.130(a)(7) Operations under VFR by day & Operations under IFR or at night — flight and navigational instruments and associated equipment .....	266
AMC1 CAT.IDE.H.125(d) & CAT.IDE.H.130(d) Operations under VFR by day & Operations under IFR or at night operations — flight and navigational instruments and associated equipment .....	267
AMC1 CAT.IDE.H.130(e) Operations under IFR or at night — flight and navigational instruments and associated equipment .....	267
AMC1 CAT.IDE.H.130(f)(6) Operations under IFR or at night — flight and navigational instruments and associated equipment .....	267
AMC1 CAT.IDE.H.130(i) Operations under IFR or at night — flight and navigational instruments and associated equipment .....	267
GM1 CAT.IDE.H.125 & CAT.IDE.H.130 Operations under VFR by day & Operations under IFR or at night — flight and navigational instruments and associated equipment .....	267
AMC1 CAT.IDE.H.145 Radio altimeters .....	268
AMC1 CAT.IDE.H.160 Airborne weather detecting equipment .....	268
AMC1 CAT.IDE.H.170 Flight crew interphone system .....	269
AMC1 CAT.IDE.H.175 Crew member interphone system .....	269
AMC1 CAT.IDE.H.180 Public address system .....	269
AMC1 CAT.IDE.H.185 Cockpit voice recorder .....	269
AMC1 CAT.IDE.H.190 Flight data recorder .....	270
AMC2 CAT.IDE.H.190 Flight data recorder .....	273
AMC3 CAT.IDE.H.190 Flight data recorder .....	278
GM1 CAT.IDE.H.190 Flight data recorder .....	289
AMC1 CAT.IDE.H.195 Data link recording .....	289
GM1 CAT.IDE.H.195 Data link recording .....	291
AMC1 CAT.IDE.H.200 Flight data and cockpit voice combination recorder .....	293
AMC1 CAT.IDE.H.205 Seats, seat safety belts, restraint systems and child restraint devices .....	293
AMC2 CAT.IDE.H.205 Seats, seat safety belts, restraint systems and child restraint devices .....	295
AMC3 CAT.IDE.H.205 Seats, seat safety belts, restraint systems and child restraint devices .....	295
AMC1 CAT.IDE.H.220 First-aid kits .....	295
AMC2 CAT.IDE.H.220 First-aid kits .....	296
AMC1 CAT.IDE.H.240 Supplemental oxygen — non-pressurised helicopters .....	296
AMC1 CAT.IDE.H.250 Hand fire extinguishers .....	296
AMC1 CAT.IDE.H.260 Marking of break-in points .....	297

AMC1 CAT.IDE.H.270 Megaphones .....	297
AMC1 CAT.IDE.H.280 Emergency locator transmitter (ELT) .....	297
AMC2 CAT.IDE.H.280 Emergency locator transmitter (ELT) .....	298
GM1 CAT.IDE.H.280 Emergency locator transmitter (ELT) .....	298
AMC1 CAT.IDE.H.290 Life-jackets .....	298
AMC2 CAT.IDE.H.290 Life-jackets .....	298
GM1 CAT.IDE.H.290 Life-jackets .....	298
GM1 CAT.IDE.H.295 Crew survival suits .....	299
AMC1 CAT.IDE.H.300 Life-rafts, survival ELTs and survival equipment on extended overwaterflights .....	302
AMC1 CAT.IDE.H.300(b)(3) & CAT.IDE.H.305(b) Flight over water & Survival equipment .....	302
AMC1 CAT.IDE.H.305 Survival equipment .....	302
GM1 CAT.IDE.H.305 Survival equipment .....	303
GM2 CAT.IDE.H.305 Survival equipment .....	303
AMC1 CAT.IDE.H.310 Additional requirements for helicopters operating to or from helidecks located in a hostile sea area .....	303
GM1 CAT.IDE.H.315 Helicopters ..... certificated for operating on water — Miscellaneous equipment	303
AMC1 CAT.IDE.H.320(b) All helicopters on flight over water — ditching .....	304
AMC1 CAT.IDE.H.325 Headset .....	304
GM1 CAT.IDE.H.325 Headset .....	304
AMC1 CAT.IDE.H.345 Communication and navigation equipment for operations under IFR or under VFR over routes not navigated by reference to visual landmarks.....	304
AMC2 CAT.IDE.H.345 Communication and navigation equipment for operations under IFR or under VFR over routes not navigated by reference to visual landmarks .....	304
AMC3 CAT.IDE.H.345 Communication and navigation equipment for operations under IFR or under VFR over routes not navigated by reference to visual landmarks.....	305
GM1 CAT.IDE.H.345 Communication and navigation equipment for operations under IFR or under VFR over routes not navigated by reference to visual landmarks .....	305
AMC1 CAT.IDE.H.350 Transponder.....	309
<b>SECTION 3—SAILPLANES .....</b>	<b>310</b>
GM1 CAT.IDE.S.100(b) Instruments and equipment—general .....	<b>Error! Bookmark not defined.</b>
GM1 CAT.IDE.S.100(c) Instruments and equipment—general.....	<b>Error! Bookmark not defined.</b>
AMC1 CAT.IDE.S.110 & CAT.IDE.S.115 Operations under VFR & cloud flying — flight and navigational instruments.....	<b>Error! Bookmark not defined.</b>
AMC1 CAT.IDE.S.110(a)(1) & CAT.IDE.S.115(a) Operations under VFR & cloud flying — flight and navigational instruments .....	<b>Error! Bookmark not defined.</b>
AMC1 CAT.IDE.S.110(a)(2) & CAT.IDE.S.115(b) Operations under VFR & cloud flying— flight and navigational instruments .....	<b>Error! Bookmark not defined.</b>
AMC1 CAT.IDE.S.110(a)(3) & CAT.IDE.S.115(c) Operations under VFR & cloud flying— flight and navigational instruments .....	<b>Error! Bookmark not defined.</b>
AMC1 CAT.IDE.S.110(a)(4) & CAT.IDE.S.115(d) Operations under VFR & cloud flying — flight and navigational instruments .....	<b>Error! Bookmark not defined.</b>
GM1 CAT.IDE.S.110(b) Operations under VFR — flight and navigational instruments .....	<b>Error! Bookmark not defined.</b>

AMC1 CAT.IDE.S.120 Seats and restraint systems .....	<b>Error! Bookmark not defined.</b>
AMC1 CAT.IDE.S.130 Flight over water.....	<b>Error! Bookmark not defined.</b>
AMC1 CAT.IDE.S.130(a) Flight over water .....	<b>Error! Bookmark not defined.</b>
GM1 CAT.IDE.S.130(a) Flight over water .....	<b>Error! Bookmark not defined.</b>
AMC1 CAT.IDE.S.130(b) Flight over water.....	<b>Error! Bookmark not defined.</b>
AMC2 CAT.IDE.S.130(b) Flight over water .....	<b>Error! Bookmark not defined.</b>
AMC3 CAT.IDE.S.130(b) Flight over water.....	<b>Error! Bookmark not defined.</b>
AMC4 CAT.IDE.S.130(b) Flight over water .....	<b>Error! Bookmark not defined.</b>
GM1 CAT.IDE.S.130(b) Flight over water .....	<b>Error! Bookmark not defined.</b>
AMC1 CAT.IDE.S.135 Survival Equipment.....	<b>Error! Bookmark not defined.</b>
AMC2 CAT.IDE.S.135 Survival equipment.....	<b>Error! Bookmark not defined.</b>
GM1 CAT.IDE.S.135 Survival equipment .....	<b>Error! Bookmark not defined.</b>
GM2 CAT.IDE.S.135 Survivalequipment.....	<b>Error! Bookmark not defined.</b>
GM1 CAT.IDE.S.145 Navigation equipment.....	<b>Error! Bookmark not defined.</b>
AMC1 CAT.IDE.S.150 Transponder.....	<b>Error! Bookmark not defined.</b>
<b>SECTION 4 — BALLOONS .....</b>	<b>311</b>
GM1 CAT.IDE.B.100(b) Instruments and equipment—general .....	<b>Error! Bookmark not defined.</b>
GM1 CAT.IDE.B.100(c) Instruments and equipment—general.....	<b>Error! Bookmark not defined.</b>
AMC1 CAT.IDE.B.110 Operating lights.....	<b>Error! Bookmark not defined.</b>
AMC1 CAT.IDE.B.115(a) Operations under VFR — flight and navigational instruments .....	<b>Error! Bookmark not defined.</b>
AMC1 CAT.IDE.B.115(b)(1) Operations under VFR — flight and navigational instruments.....	<b>Error! Bookmark not defined.</b>
GM1 CAT.IDE.B.115(b)(2) Operations under VFR — flight and navigational instruments.....	<b>Error! Bookmark not defined.</b>
GM1 CAT.IDE.B.115(b)(3) Operations under VFR — flight and navigational instruments and associated equipment.....	<b>Error! Bookmark not defined.</b>
AMC1 CAT.IDE.B.120 Restraint systems .....	<b>Error! Bookmark not defined.</b>
AMC1 CAT.IDE.B.125 First-aid kit.....	<b>Error! Bookmark not defined.</b>
AMC2 CAT.IDE.B.125 First-aid kit.....	<b>Error! Bookmark not defined.</b>
AMC1 CAT.IDE.B.135 Hand fire extinguishers .....	<b>Error! Bookmark not defined.</b>
AMC1 CAT.IDE.B.140 Flight over water.....	<b>Error! Bookmark not defined.</b>
AMC1 CAT.IDE.B.140(a) Flight over water.....	<b>Error! Bookmark not defined.</b>
AMC1 CAT.IDE.B.140(b) Flight over water .....	<b>Error! Bookmark not defined.</b>
AMC2 CAT.IDE.B.140(b) Flight over water .....	<b>Error! Bookmark not defined.</b>
AMC3 CAT.IDE.B.140(b) Flight over water.....	<b>Error! Bookmark not defined.</b>
AMC4 CAT.IDE.B.140(b) Flight over water.....	<b>Error! Bookmark not defined.</b>
GM1 CAT.IDE.B.140(b) Flight over water .....	<b>Error! Bookmark not defined.</b>
GM1 CAT.IDE.B.140(c) Flight over water .....	<b>Error! Bookmark not defined.</b>
AMC1 CAT.IDE.B.145 Survival equipment.....	<b>Error! Bookmark not defined.</b>
AMC2 CAT.IDE.B.145 Survivalequipment.....	<b>Error! Bookmark not defined.</b>
GM1 CAT.IDE.B.145 Survivalequipment .....	<b>Error! Bookmark not defined.</b>
GM2 CAT.IDE.B.145 Survivalequipment.....	<b>Error! Bookmark not defined.</b>
AMC1 CAT.IDE.B.150(b)(3) Miscellaneous equipment.....	<b>Error! Bookmark not defined.</b>



AMC1 CAT.IDE.B.140(c)(1) Miscellaneous equipment ..... **Error! Bookmark not defined.**  
GM1 CAT.IDE.B.155 Radio communication equipment ..... **Error! Bookmark not defined.**  
AMC1 CAT.IDE.B.160 Transponder ..... **Error! Bookmark not defined.**

## **SUBPART A — General requirements**

### **SECTION I — Motor-powered aircraft**

#### **AMC1 CAT.GEN.MPA.100(b) Crew responsibilities**

##### COPIES OF REPORTS

Where a written report is required, a copy of the report should be communicated to the commander concerned unless the terms of the operator's reporting schemes prevent this.

#### **AMC1 CAT.GEN.MPA.100(c)(1) Crew responsibilities**

##### ALCOHOL CONSUMPTION

The operator should issue instructions concerning the consumption of alcohol by crew members. The instructions should be not less restrictive than the following:

- (a) no alcohol should be consumed less than 8 hours prior to the specified reporting time for a flight duty period or the commencement of standby;
- (b) the blood alcohol level should not exceed the lower of the national requirements or 0.2 per thousand at the start of a flight duty period;
- (c) no alcohol should be consumed during the flight duty period or whilst on standby.

#### **GM1 CAT.GEN.MPA.100(c)(2) Crew responsibilities**

##### ELAPSED TIME BEFORE RETURNING TO FLYING DUTY

24 hours is a suitable minimum length of time to allow after normal blood donation or normal recreational (sport) diving before returning to flying duties. This should be considered by operators when determining a reasonable time period for the guidance of crew members.

##### PART- MED

Information on the effects of medication, drugs, other treatments and alcohol can be found in Part-MED of LCARs Aircrew.

#### **GM1 CAT.GEN.MPA.105(a)(10) Responsibilities of the commander**

##### IDENTIFICATION OF THE SEVERITY OF AN OCCURRENCE BY THE COMMANDER

The definitions of an accident and a serious incident as well as examples thereof can be found in Regulation (EU) No 996/2010 of the European Parliament and of the Council

#### **AMC1 CAT.GEN.MPA.115(a) Personnel or crew members other than cabin crew in the passenger compartment**

##### MEASURES TO PREVENT CONFUSION BY PASSENGERS

If personnel or crew members other than operating cabin crew members carry out duties in a passenger compartment, the operator should ensure that they do not perform tasks or wear a uniform in such a way that might identify them as members of the operating cabin crew.

#### **GM1 CAT.GEN.MPA.115 Personnel or crew members other than cabin crew in the passenger AMC1 CAT.GEN.MPA.195(b) compartment**

##### POSITIONING CABIN CREW MEMBERS

To prevent confusion by passengers and undue expectations in case of emergency, positioning cabin crew members should not wear, or should at least make invisible to passengers, parts of the operator's cabin crew uniform, such as main jacket or crew signs or badges, that might identify them as members of the operating cabin crew.

#### **AMC1 CAT.GEN.MPA.124 Taxiing of aircraft**

## PROCEDURES FOR TAXIING

Procedures for taxiing should include at least the following:

- (a) application of the sterile flight crew compartment procedures;
- (b) use of standard radio-telephony (RTF) phraseology;
- (c) use of lights;
- (d) measures to enhance the situational awareness of the minimum required flight crew members. The following list of typical items should be adapted by the operator to take into account its operational environment:
  - (1) each flight crew member should have the necessary aerodrome layout charts available;
  - (2) the pilot taxiing the aircraft should announce in advance his/her intentions to the pilot monitoring;
  - (3) all taxi clearances should be heard and should be understood by each flight crew member;
  - (4) all taxi clearances should be cross-checked against the aerodrome chart and aerodrome surface markings, signs, and lights;
  - (5) an aircraft taxiing on the manoeuvring area should stop and hold at all lighted stop bars, and may proceed further when an explicit clearance to enter or cross the runway has been issued by the aerodrome control tower, and when the stop bar lights are switched
  - (6) if the pilot taxiing the aircraft is unsure of his/her position, he/she should stop the aircraft and contact air traffic control;
  - (7) the pilot monitoring should monitor the taxi progress and adherence to the clearances, and should assist the pilot taxiing;
  - (8) any action which may disturb the flight crew from the taxi activity should be avoided or done with the parking brake set (e.g. announcements by public address);
- (e) subparagraphs (d)(2) and (d)(7) are not applicable to single-pilot operations.

## **GM1 CAT.GEN.MPA.125 Taxiing of aeroplanes**

### SKILLS AND KNOWLEDGE

The following skills and knowledge may be assessed to check if a person can be authorised by the operator to taxi an aeroplane:

positioning of the aeroplane to ensure safety when starting engine;

- (a) getting ATIS reports and taxi clearance, where applicable;
- (b) (interpretation of airfield markings/lights/signals/indicators);
- (c) interpretation of marshalling signals, where applicable;
- (d) identification of suitable parking area;
- (e) maintaining lookout and right-of-way rules and complying with air traffic control (ATC) or marshalling instructions, when applicable;
- (f) avoidance of adverse effect of propeller slipstream or jet wash on other aeroplanes, aerodrome facilities and personnel;
- (g) inspection of taxi path when surface conditions are obscured;
- (h) communication with others when controlling an aeroplane on the ground;
- (i) interpretation of operational instructions;
- (j) reporting of any problem that may occur while taxiing an aeroplane; and
- (k) adapting the taxi speed in accordance with prevailing aerodrome, traffic, surface and weather conditions.

**GM2 CAT.GEN.MPA.125 Taxiing of aeroplanes**

## SAFETY-CRITICAL ACTIVITY

- (a) Taxiing should be treated as a safety -critical activity due to the risks related to the movement of the aeroplane and the potential for a catastrophic event on the ground.
- (b) Taxiing is a high-workload phase of flight that requires the full attention of the flight crew.

**GM1 CAT.GEN.MPA.130 Rotor engagement — helicopters**

## INTENT OF THE RULE

- (a) The following two situations where it is allowed to turn the rotor under power should be distinguished:
  - (1) for the purpose of flight, this is described in the Implementing Rule;
  - (2) for maintenance purposes.
- (b) Rotor engagement for the purpose of flight: the pilot should not leave the control when the rotors are turning. For example, the pilot is not allowed to get out of the aircraft in order to welcome passengers and adjust their seat belts with the rotors turning.
- (c) Rotor engagement for the purpose of maintenance: the Implementing Rule, however, does not prevent ground runs being conducted by qualified personnel other than pilots for maintenance purposes.
- (d) The following conditions should be applied:
  - (1) the operator should ensure that the qualification of personnel, other than pilots, who are authorised to conduct maintenance runs is described in the appropriate manual;
  - (2) ground runs should not include taxiing the helicopter;
  - (3) there should be no passengers on board; and
  - (4) maintenance runs should not include collective increase or autopilot engagement (due to the risk of ground resonance).

**AMC1 CAT.GEN.MPA.135(a)(3) Admission to the flight crew compartment**

## INSTRUCTIONS FOR SINGLE- PILOT OPERATIONS UNDER VFR BY DAY

Where an aircraft is used in a single-pilot operation under visual flight rules (VFR) by day, but has more than one pilot station, the instructions of the operator may permit passengers to be carried in the unoccupied pilot seat(s), provided that the commander is satisfied that:

- (a) it will not cause distraction or interference with the operation of the flight; and
- (b) the passenger occupying a pilot seat is familiar with the relevant restrictions and safety procedures.

**AMC1 CAT.GEN.MPA.140 Portable electronic devices**

## TECHNICAL PREREQUISITES FOR THE USE OF PEDS

- (a) Scope  
This AMC describes the technical prerequisites under which any kind of portable electronic device (PED) may be used on board the aircraft without adversely affecting the performance of the aircraft's systems and equipment.
- (b) Prerequisites concerning the aircraft configuration

- (1) Before an operator may permit the use of any kind of PED on-board, it should ensure that PEDs have no impact on the safe operation of the aircraft. The operator should demonstrate that PEDs do not interfere with on-board electronic systems and equipment, especially with the aircraft's navigation and communication systems.
  - (2) The assessment of PED tolerance may be tailored to the different aircraft zones for which the use of PEDs is considered, i.e. may address separately:
    - (i) the passenger compartment;
    - (ii) the flight crew compartment; and
    - (iii) areas not accessible during the flight.
- (c) Scenarios for permitting the use of PEDs
- (1) Possible scenarios, under which the operator may permit the use of PEDs, should be as documented in Table 1. The scenarios in Table 1 are listed in a descending order with the least permitting scenario at the bottom.
  - (2) Restrictions arising from the corresponding aircraft certification, as documented in the aircraft flight manual (AFM) or equivalent document(s), should stay in force. They may be linked to different aircraft zones, or to particular transmitting technologies covered.
  - (3) For Scenarios Nos. 3 to 8 in Table 1 the use of C-PEDs and cargo tracking devices may be further expanded, when the EMI assessment has demonstrated that there is no impact on safety as follows:
    - (i) for C-PEDs by using the method described in (d)(2); and
    - (ii) for cargo tracking devices by using the method described in (d)(3).

**Table 1** – Scenarios for permitting the use of PEDs by the operator

No.	Technical condition	Non-intentional transmitters	T-PEDs
1	The aircraft is certified as T-PED tolerant, i.e. it has been demonstrated during the aircraft certification process that front door and back door coupling have no impact on the safe operation of the aircraft	All phases of flight	All phases of flight
2	A complete electromagnetic interference (EMI) assessment for all technologies, using the method described in (d)(1), has been performed and has demonstrated the T-PED tolerance	All phases of flight	All phases of flight
3	The aircraft is certified for the use of T-PEDs using particular technologies (e.g. WLAN or mobile phone)	All phases of flight	All phases of flight, restricted to those particular technologies
4	The EMI assessment, using the method described in (d)(1), has demonstrated that: (a) the front door coupling has no impact on safety; and (b) the back door coupling has no impact on safety when using particular technologies (e.g. WLAN or mobile phone)	All phases of flight	All phases of flight, restricted to those particular technologies
5	The EMI assessment, using the method described in (d)(1)(i), has demonstrated that the front door coupling has no impact on safety caused by nonintentional transmitters	All phases of flight	Not permitted
6	The EMI assessment, using the method described in (d)(1)(ii), has demonstrated that the back door coupling has no impact on safety when using particular technologies (e.g. WLAN or mobile phone)	All phases of flight - except low visibility approach operation	All phases of flight - except low visibility approach operation, restricted to those particular technologies
7	An EMI assessment has not been performed	All phases of flight - except low visibility approach operation	Not permitted
8	Notwithstanding Scenarios Nos. 3 to 7	(a) before taxi-out; (b) during taxi-in after the end of landing roll; and (c) the commander may permit the use during prolonged departure delays, provided that sufficient time is available to check the passenger compartment before the flight proceeds	

- (d) Demonstration of electromagnetic compatibility
- (1) EMI assessment at aircraft level
- The means to demonstrate that the radio frequency (RF) emissions (intentional or non-intentional) are tolerated by aircraft systems should be as follows:
- (i) to address front door coupling susceptibility for any kind of PEDs:
- (A) RTCA, 'Guidance on allowing transmitting portable, electronic devices (T-PEDs) on aircraft', DO-294C (or later revisions), Appendix 5C; or
- (B) RTCA, 'Aircraft design and certification for portable electronic device (PED) tolerance', DO-307 (including Change 1 or later revisions), Section 4; and
- (ii) to address back door coupling susceptibility for T-PEDs:
- (A) EUROCAE, 'Guidance for the use of portable electronic devices (PEDs) on board aircraft', ED-130 (or later revisions), Annex 6;
- (B) RTCA DO-294C (or later revisions), Appendix 6D; or
- (C) RTCA DO-307 (including Change 1 or later revisions), Section 3.
- (2) Alternative EMI assessment of C-PEDs
- (i) For front door coupling:
- (A) C-PEDs should comply with the levels as defined by:
- (a) EUROCAE/RTCA, 'Environmental conditions and test procedures for airborne equipment', ED-14D/DO-160D (or later revisions), Section 21, Category M, for operation in the passenger compartment and the flight crew compartment; and
- (b) EUROCAE ED-14E/RTCA DO-160E (or later revisions), Section 21, Category H, for operation in areas not accessible during the flight.
- (B) If the C-PEDs are electronic flight bags used in the flight crew compartment, an alternative compliance method described in EASA, 'General acceptable means of compliance for airworthiness of products, part and appliances', AMC-20, AMC 20- 25 ('Airworthiness and operational considerations for electronic flight bags'), may be used.
- (ii) For back door coupling the EMI assessment described in (1)(ii) should be performed.
- (3) Alternative EMI assessment of cargo tracking devices
- In case a transmitting function is automatically deactivated in a cargo tracking device (being a T-PED), the unit should be qualified for safe operation on board the aircraft. One of the following methods should be considered acceptable as evidence for safe operation:
- (i) A type-specific safety assessment, including failure mode and effects analysis, has been performed at aircraft level. The main purpose of the assessment should be to determine the worst hazards and to demonstrate an adequate design assurance level of the relevant hardware and software components of the cargo tracking device.
- (ii) The high intensity radiated field (HIRF) certification of the aircraft has been performed, i.e. the aircraft type has been certified after 1987 and meets the appropriate special condition. In such a case, the operator should observe the following:

- (A) The tracking device:
  - (a) features an automated and prolonged radio suspension in flight using multiple modes of redundancy; and
  - (b) has been verified in the aircraft environment to ensure deactivation of the transmitting function in flight.
- (B) The transmissions of the tracking device are limited per design to short periods of time (less than 1 second per 1 000 seconds) and cannot be continuous.
- (C) The tracking device emissions should comply with the levels as defined by EUROCAE ED-14E/RTCA DO-160E (or later revisions), Section 21, Category H.
- (D) In order to provide assurance on the tracking device design and production, the following documents are retained as part of the evaluation package:
  - (a) operational description, technical specifications, product label and images of the tracking device and any peripheral attachments;
  - (b) failure mode and effects analysis report of the tracking device and any peripheral attachments;
  - (c) declaration of stringent design and production controls in place during the tracking device manufacturing;
  - (d) declaration of conformity and technical documentation showing compliance to the European Norms (EN), regulating the transmitter characteristic of the tracking device or its transmission module; and
  - (e) an EMI assessment report documenting the emission levels.
- (iii) The tracking device interference levels during transmission are below those considered acceptable for the specific aircraft environment.
- (e) Operational conditions of C-PEDs and cargo tracking devices
 

The operator should ensure that C-PEDs and cargo tracking devices are maintained in good and safe condition, having in mind that:

  - (1) damage may modify their emissions characteristics; and
  - (2) damage to the battery may create a fire hazard.
- (a) Batteries in C-PEDs and cargo tracking devices
 

Lithium-type batteries in C-PEDs and cargo tracking devices should meet:

  - (1) United Nations (UN) Transportation Regulations, 'Recommendations on the transport of dangerous goods - manual of tests and criteria', UN ST/SG/AC.10/11; and
  - (2) one of the following standards:
    - (i) Underwriters Laboratory, 'Lithium batteries', UL 1642;
    - (ii) Underwriters Laboratory, 'Household and commercial batteries', UL 2054;
    - (iii) Underwriters Laboratory, 'Information technology equipment – safety', UL 60950-1;
    - (iv) International Electrotechnical Commission (IEC), 'Secondary cells and batteries containing alkaline or other non-acid electrolytes - safety requirements for portable sealed secondary cells, and for batteries made from them, for use in portable applications', IEC 62133;



- (v) RTCA, 'Minimum operational performance standards for rechargeable lithium battery systems', DO-311. RTCA DO-311 may be used to address concerns regarding overcharging, over-discharging, and the flammability of cell components. The standard is intended to test permanently installed equipment; however, these tests are applicable and sufficient to test electronic flight bags rechargeable lithium-type batteries; or
- (vi) European Technical Standard Order (ETSO), 'Non-rechargeable lithium cells and batteries', ETSO C142a.

## **AMC2 CAT.GEN.MPA.140 Portable electronic devices**

### PROCEDURES FOR THE USE OF PEDS

#### (a) Scope

This AMC describes the procedures under which any kind of portable electronic device (PED) may be used on board the aircraft without adversely affecting the performance of the aircraft's systems and equipment. This AMC addresses the operation of PEDs in the different aircraft zones — passenger compartment, flight compartment, and areas inaccessible during the flight.

#### (b) Prerequisites

Before permitting the use of any kind of PEDs the operator should ensure compliance with (c) of AMC1 CAT.GEN.MPA.140.

#### (c) Hazard identification and risk assessment

The operator should identify the safety hazards and manage the associated risks following the management system implemented in accordance with ORO.GEN.200. The risk assessment should include hazards associated with:

- (1) PEDs in different aircraft zones;
- (2) PED use during various phases of flight;
- (3) PED use during turbulence;
- (4) improperly stowed PEDs;
- (5) impeded or slowed evacuations;
- (6) passenger non-compliance, e.g. not deactivating transmitting functions, not switching off PEDs or not stowing PEDs properly;
- (7) disruptive passengers; and
- (8) battery fire.

#### (d) Use of PEDs in the passenger compartment

##### (1) Procedures and training

If an operator permits passengers to use PEDs on board its aircraft, procedures should be in place to control their use. These procedures should include provisions for passenger briefing, passenger handling and for the stowage of PEDs. The operator should ensure that all crew members and ground personnel are trained to enforce possible restrictions concerning the use of PEDs, in line with these procedures.

##### (2) Provisions for use

- (i) The use of PEDs in the passenger compartment may be granted under the responsibility of the operator, i.e. the operator decides which PED may be used during which phases of the flight.
- (ii) Notwithstanding (b), medical equipment necessary to support physiological functions may be used at all times and does not need to be switched-off.

##### (3) Stowage, passenger information and passenger briefing of PEDs

- (i) In accordance with CAT.OP.MPA.160 the operator should establish procedures concerning the stowage of PEDs. The operator should:
    - (A) identify the phases of flight in which PEDs are to be stowed; and
    - (B) determine suitable stowage locations, taking into account the PEDs' size and weight.
  - (ii) The operator should provide general information on the use of PEDs to the passengers before the flight. This information should specify at least:
    - (A) which PEDs can be used during which phases of the flight;
    - (B) when and where PEDs are to be stowed; and
    - (C) that the instructions of the crew are to be followed at all times.
  - (iii) In accordance with CAT.OP.MPA.170, the use of PEDs should be part of the passenger briefings. The operator should remind passengers to pay attention and to avoid distraction during such briefings.
- (4) In-seat electrical power supplies
- Where in-seat electrical power supplies are available for passenger use, the following should apply:
- (i) information giving safety instructions should be provided to the passengers;
  - (ii) PEDs should be disconnected from any in-seat electrical power supply during taxiing, take-off, approach, landing, and during abnormal or emergency conditions; and
  - (iii) flight crew, cabin crew and technical crew should be aware of the proper means to switch-off in-seat power supplies used for PEDs.
- (5) Operator's safety measures during boarding and any phase of flight
- (i) Appropriate coordination between flight crew, cabin crew and technical crew should be established to deal with interference or other safety problems associated with PEDs.
  - (ii) Suspect equipment should be switched off.
  - (iii) Particular attention should be given to passenger misuse of equipment.
  - (iv) Thermal runaways of batteries, in particular lithium batteries, and potential resulting fire, should be handled properly.
  - (v) The commander may, for any reason and during any phase of flight, require deactivation and stowage of PEDs.
  - (vi) When the operator restricts the use of PEDs, consideration should be given to handle special requests to operate a T-PED during any phase of the flight for specific reasons (e.g. for security measures).
- (6) Reporting
- Occurrences of suspected or confirmed interference should be reported to the competent authority. Where possible, to assist follow-up and technical investigation, reports should describe the suspected device, identify the brand name and model number, its location in the aircraft at the time of the occurrence, interference symptoms, the device user's contact details and the results of actions taken by the crew.
- (f) Use of PEDs in the flight crew compartment
- In the flight crew compartment the operator may permit the use of PEDs, e.g. to assist the flight crew in their duties, when procedures are in place to ensure the following:

- (1) The conditions for the use of PEDs in-flight are specified in the operations manual.
  - (2) The PEDs do not pose a loose item risk or other hazard.
  - (3) These provisions should not preclude use of a T-PED (specifically a mobile phone) by the flight crew to deal with an emergency. However, reliance should not be predicated on a T-PED for this purpose.
- (g) PEDs not accessible during the flight
- PEDs should be switched off, when not accessible for deactivation during flight. This should apply especially to PEDs contained in baggage or transported as part of the cargo. The operator may permit deviation for PEDs for which safe operation has been demonstrated in accordance with AMC1 CAT.GEN.MPA.140. Other precautions, such as transporting in shielded metal boxes, may also be used to mitigate associated risks.

## **GM1 CAT.GEN.MPA.140 Portable electronic devices**

### DEFINITIONS

- (a) Definition and categories of PEDs

PEDs are any kind of electronic device, typically but not limited to consumer electronics, brought on board the aircraft by crew members, passengers, or as part of the cargo and that are not included in the approved aircraft configuration. All equipment that is able to consume electrical energy falls under this definition. The electrical energy can be provided from internal sources as batteries (chargeable or non-rechargeable) or the devices may also be connected to specific aircraft power sources.

PEDs include the following two categories:

- (1) Non-intentional transmitters can non-intentionally radiate RF transmissions, sometimes referred to as spurious emissions. This category includes, but is not limited to, calculators, cameras, radio receivers, audio and video players, electronic games and toys when these devices are equipped with a transmitting function.
  - (2) Intentional transmitters can radiate RF transmissions on specific frequencies as part of their intended function. In addition, they may radiate non-intentional transmissions like any PED. The term 'transmitting PED' (T-PED) is used to identify the transmitting capability of the PED. Intentional transmitters are transmitting devices such as RF-based remote control equipment, which may include some toys, two-way radios (sometimes referred to as 'private mobile radio'), mobile phones of any type, satellite phones, computer with mobile phone data connection, wireless local area network (WLAN) or Bluetooth capability. After deactivation of the transmitting capability, e.g. by activating the so-called 'flight mode' or 'flight safety mode', the T-PED remains a PED having non-intentional emissions.
- (b) A controlled PED (C- PED)
- A controlled PED (C- PED) is a PED subject to administrative control by the operator using it. This will include, inter alia, tracking the allocation of the devices to specific aircraft or persons and ensuring that no unauthorised changes are made to the hardware, software or databases. C- PEDs can be assigned to the category of non-intentional transmitters or T-PEDs.
- (c) Cargo tracking device
- A cargo tracking device is a PED attached to or included in airfreight (e.g. in or on containers, pallets, parcels or baggage). Cargo tracking devices can be assigned

to the category of non-intentional transmitters or T-PEDs. If the device is a T-PED, it complies with the European Norms (EN) for transmissions.

(d) Definition of the switched-off status

Many PEDs are not completely disconnected from the internal power source when switched off. The switching function may leave some remaining functionality e.g. data storage, timer, clock, etc. These devices can be considered switched off when in the deactivated status. The same applies to devices having no transmitting capability and are operated by coin cells without further deactivation capability, e.g. wrist watches.

(e) Electromagnetic interference (EMI)

The two classes of EMI to be addressed can be described as follows:

- (1) Front door coupling is the possible disturbance to an aircraft system as received by the antenna of the system and mainly in the frequency band used by the system. Any PED internal oscillation has the potential to radiate low level signals in the aviation frequency bands. Through this disturbance especially the instrument landing system (ILS) and the VHF omni range (VOR) navigation system may indicate erroneous information.
- (2) Back door coupling is the possible disturbance of aircraft systems by electromagnetic fields generated by transmitters at a level which could exceed on short distance (i.e. within the aircraft) the electromagnetic field level used for the aircraft system certification. This disturbance may then lead to system malfunction.

### **GM2 CAT.GEN.MPA.140 Portable electronic devices**

#### **CREW REST COMPARTMENT, NAVIGATION, TEST ENTITIES AND FIRE CAUSED BY PEDS**

When the aircraft is equipped with a crew rest compartment, it is considered being part of the passenger compartment.

- (a) Front door coupling may influence the VOR navigation system. Therefore, the flight crew monitors other navigation sensors to detect potential disturbances by PEDs, especially during low visibility departure operation based on VOR guidance.
- (b) Specific equipment, knowledge and experience are required, when the industry standards for evaluating technical prerequisites for the use of PEDs are applied. In order to ensure conformity with the industry standards, the operator is encouraged to cooperate with an appropriately qualified and experienced entity, as necessary. For this entity an aviation background is not required, but is considered to be beneficial.
- (c) Guidance to follow in case of fire caused by PEDs is provided by the International Civil Aviation Organisation, 'Emergency response guidance for aircraft incidents involving dangerous goods', ICAO Doc 9481-AN/928.

### **GM3 CAT.GEN.MPA.140 Portable electronic devices**

#### **CARGO TRACKING DEVICES EVALUATION**

##### **Safety assessment**

- (a) Further guidance on performing a safety assessment can be found in:
  - (1) EASA, 'Certification specifications and acceptable means of compliance for large aeroplanes' CS-25, Book 2, AMC-Subpart F, AMC 25.1309;
  - (2) EUROCAE/SAE, 'Guidelines for development of civil aircraft and systems', ED-79/ARP 4754 (or later revisions); and
  - (3) SAE, 'Guidelines and methods for conducting the safety assessment process on civil airborne systems and equipment', ARP 4761 (or later revisions).

## (b) HIRF certification

The type certificate data sheet (TCDS), available on the EASA website for each aircraft model having EASA certification, lists whether the HIRF certification has been performed through a special condition. The operator may contact the type certification holder to gain the necessary information.

## (c) Failure mode and effects analysis

Further guidance on performing a failure mode and effects analysis can be found in:

- (1) SAE ARP 4761 (or later revisions); and
- (2) U.S. Department of Defense, 'Procedures for performing a failure mode, effects and criticality analysis', Military Standard MIL-STD-1629A (or later revisions).

### **AMC1 CAT.GEN.MPA.145 Information on emergency and survival equipment carried**

#### ITEMS FOR COMMUNICATION TO THE RESCUE COORDINATION CENTRE

The information, compiled in a list, should include, as applicable, the number, colour and type of life rafts and pyrotechnics, details of emergency medical supplies, e.g. first-aid kits, emergency medical kits, water supplies and the type and frequencies of emergency portable radio equipment.

### **GM1 CAT.GEN.MPA.155 Carriage of weapons of war and munitions of war**

#### WEAPONS OF WAR AND MUNITIONS OF WAR

In accordance with Regulation (EC) No 300/2008, weapons of war may be carried on board an aircraft, in a place that is not inaccessible, if the required security conditions in accordance with national laws have been fulfilled and authorisation has been given by the States involved.

- (a) There is no internationally agreed definition of weapons of war and munitions of war. Some States may have defined them for their particular purposes or for national need.
- (b) It is the responsibility of the operator to check, with the State(s) concerned, whether or not a particular weapon or munition is regarded as a weapon of war or munitions of war. In this context, States that may be concerned with granting approvals for the carriage of weapons of war or munitions of war are those of origin, transit, overflight and destination of the consignment and the State of the operator.
- (c) Where weapons of war or munitions of war are also dangerous goods by definition (e.g. torpedoes, bombs, etc.), CAT.GEN.MPA.200 Transport of dangerous goods also applies.

### **GM1 CAT.GEN.MPA.160 Carriage of sporting weapons and ammunition**

#### SPORTING WEAPONS

In accordance with Regulation (EC) No 300/2008 sporting weapons may be carried on board an aircraft, in a place that is not inaccessible, if the required security conditions in accordance with national laws have been fulfilled and authorisation has been given by the States involved.

- (a) There is no internationally agreed definition of sporting weapons. In general, it may be any weapon that is not a weapon of war or munitions of war. Sporting weapons include hunting knives, bows and other similar articles. An antique weapon, which at one time may have been a weapon of war or munitions of war, such as a musket, may now be regarded as a sporting weapon.
- (b) A firearm is any gun, rifle or pistol that fires a projectile.

- (c) The following firearms are generally regarded as being sporting weapons:
  - (1) those designed for shooting game, birds and other animals;
  - (2) those used for target shooting, clay-pigeon shooting and competition shooting, providing the weapons are not those on standard issue to military forces; and
  - (3) airguns, dart guns, starting pistols, etc.
- (d) A firearm, which is not a weapon of war or munitions of war, should be treated as a sporting weapon for the purposes of its carriage on an aircraft.

### **AMC1 CAT.GEN.MPA.161 Carriage of sporting weapons and ammunition — alleviations**

#### **SPORTING WEAPONS — HELICOPTERS**

Procedures for the carriage of sporting weapons may need to be considered if the helicopter does not have a separate compartment in which the weapons can be stowed. These procedures should take into account the nature of the flight, its origin and destination, and the possibility of unlawful interference. As far as possible, the weapons should be stowed so they are not immediately accessible to the passengers, e.g. in locked boxes, in checked baggage that is stowed under other baggage or under fixed netting.

### **AMC1 CAT.GEN.MPA.180 Documents, manuals and information to be carried**

#### **GENERAL**

The documents, manuals and information may be available in a form other than on printed paper. Accessibility, usability and reliability should be assured.

### **GM1 CAT.GEN.MPA.180(a)(1) Documents, manuals and information to be carried**

#### **AIRCRAFT FLIGHT MANUAL OR EQUIVALENT DOCUMENT(S)**

‘Aircraft flight manual, or equivalent document(s)’ means in the context of this rule the flight manual for the aircraft, or other documents containing information required for the operation of the aircraft within the terms of its certificate of airworthiness unless these data are available in the parts of the operations manual carried on board.

### **GM1 CAT.GEN.MPA.180(a)(5)(6) Documents, manuals and information to be carried**

#### **CERTIFIED TRUE COPIES**

- (a) Certified true copies may be provided:
  - (1) directly by the LyCAA; or
  - (2) by persons holding privileges for certification of official documents in accordance with the applicable Member State’s legislation, e.g. public notaries, authorised officials in public services.
- (b) Translations of the air operator certificate (AOC) including operations specifications do not need to be certified.

### **GM1 CAT.GEN.MPA.180(a)(9) Documents, manuals and information to be carried**

#### **JOURNEY LOG OR EQUIVALENT**

‘Journey log or equivalent’ means that the required information may be recorded in documentation other than a log book, such as the operational flight plan or the aircraft technical log.

**AMC1 CAT.GEN.MPA.180(a)(13) Documents, manuals and information to be carried****PROCEDURES AND VISUAL SIGNALS FOR USE BY INTERCEPTING AND INTERCEPTED AIRCRAFT**

The procedures and the visual signals information for use by intercepting and intercepted aircraft should reflect those contained in International Civil Aviation Organization (ICAO) Annex 2. This may be part of the operations manual.

**GM1 CAT.GEN.MPA.180(a)(14) Documents, manuals and information to be carried****SEARCH AND RESCUE INFORMATION**

This information is usually found in the State's aeronautical information publication.

**GM1 CAT.GEN.MPA.180(a)(23) Documents, manuals and information to be carried****DOCUMENTS THAT MAY BE PERTINENT TO THE FLIGHT**

Any other documents that may be pertinent to the flight or required by the States concerned with the flight, may include, for example, forms to comply with reporting requirements.

**STATES CONCERNED WITH THE FLIGHT**

The States concerned are those of origin, transit, overflight and destination of the flight.

**AMC1 CAT.GEN.MPA.195(a) Handling of flight recorder recordings: preservation, production, protection and use****PRESERVATION OF RECORDED DATA FOR INVESTIGATION**

- (a) The operator should establish procedures to ensure that flight recorder recordings are preserved for the investigating authority.
- (b) These procedures should include:
  - (1) instructions for flight crew members to deactivate the flight recorders immediately after completion of the flight and inform relevant personnel that the recording of the flight recorders should be preserved. These instructions should be readily available on board; and
  - (2) instructions to prevent inadvertent reactivation, test, repair or reinstallation of the flight recorders by operator personnel or during maintenance or ground handling activities performed by third parties.

**GM1 CAT.GEN.MPA.195(a) Preservation, production and use of flight recorder recordings Handling of flight recorder recordings: preservation, production, protection and use****REMOVAL OF RECORDERS IN CASE OF AN INVESTIGATION**

The need for removal of the recorders from the aircraft is determined by the investigating authority with due regard to the seriousness of an occurrence and the circumstances, including the impact on the operation.

**AMC1 CAT.GEN.MPA.195(b) Preservation, production and use of flight recorder recordings Handling of flight recorder recordings: preservation, production, protection and use****INSPECTIONS AND CHECKS OF RECORDINGS**

Whenever a flight recorder is required to be carried, the operator should:

- (a) the operator should perform an annual inspection of the FDR recording and the CVR recording every year unless one or more of the following applies:

- (1) If the flight recorder records on magnetic wire or uses frequency modulation technology, the time interval between two inspections of the recording should not exceed three months..
- (2) If the flight recorder is solid-state and the flight recorder system is fitted with continuous monitoring for proper operation, the time interval between two inspections of the recording may be up to two years.
- (3) In the case of an aircraft equipped with two solid-state flight data and cockpit voice combination recorders, where
  - (i) the flight recorder systems are fitted with continuous monitoring for proper operation, and
  - (ii) the flight recorders share the same flight data acquisition, a comprehensive inspection of the recording needs only to be performed for one flight recorder position. The inspection of the recordings should be performed alternately so that each flight recorder position is inspected at time intervals not exceeding four years
- (4) Where all of the following conditions are met, the inspection of the FDR recording is not needed:
  - (i) the aircraft flight data are collected in the frame of a flight data monitoring (FDM) programme;
  - (ii) the data acquisition of mandatory flight parameters is the same for the FDR and for the recorder used for the FDM programme;
  - (iii) an inspection similar to the inspection of the FDR recording and covering all mandatory flight parameters is conducted on the FDM data at time intervals not exceeding two years; and
  - (iv) the FDR is solid- state and the FDR system is fitted with continuous monitoring for proper operation.
- (b) the operator should perform every five years an inspection of the data link recording; and
- (c) when installed, the aural or visual means for preflight checking the flight recorders for proper operation should be used every day. When no such means is available for a flight recorder, the operator should perform an operational check of this flight recorder at time intervals not exceeding seven calendar days of operation.
- (d) the operator should check every 5 five years, or in accordance with the recommendations of the sensor manufacturer, that the parameters dedicated to the FDR and not monitored by other means are being recorded within the calibration tolerances and that there is no discrepancy in the engineering conversion routines for these parameters

**GM1 CAT.GEN.MPA.195(b) Preservation, production and use of flight recorder recordings Handling of flight recorder recordings: preservation, production, protection and use**

**INSPECTION OF THE FLIGHT RECORDERS RECORDING**

- (a) The inspection of the FDR recording usually consists of the following:
  - (1) Making a copy of the complete recording file.
  - (2) Converting the recording to parameters expressed in engineering units in accordance with the documentation required to be held.



- (3) Examining a whole flight in engineering units to evaluate the validity of all mandatory parameters — this could reveal defects or noise in the measuring and processing chains and indicate necessary maintenance actions. The following should be considered:
  - (i) when applicable, each parameter should be expressed in engineering units and checked for different values of its operational range — for this purpose, some parameters may need to be inspected at different flight phases; and
  - (ii) if the parameter is delivered by a digital data bus and the same data are utilised for the operation of the aircraft, then a reasonableness check may be sufficient; otherwise a correlation check may need to be performed;
    - (A) a reasonableness check is understood in this context as a subjective, qualitative evaluation, requiring technical judgement, of the recordings from a complete flight; and
    - (B) a correlation check is understood in this context as the process of comparing data recorded by the flight data recorder against the corresponding data derived from flight instruments, indicators or the expected values obtained during specified portion(s) of a flight profile or during ground checks that are conducted for that purpose.
- (4) Retaining the most recent copy of the complete recording file and the corresponding recording inspection report.
- (b) When performing the CVR recording inspection, precautions need to be taken to comply with CAT.GEN.MPA.195(f)(1a). The inspection of the CVR recording usually consists of
  - (1) checking that the CVR operates correctly for the nominal duration of the recording;
  - (2) examining, where practicable and subject to prior approval by the flight crew, a sample of in-flight recording of the CVR for evidence that the signal is acceptable on each channel; and
  - (3) preparing and retaining an inspection report.
- (c) The inspection of the DLR recording usually consists of:
  - (1) Checking the consistency of the data link recording with other recordings for example, during a designated flight, the flight crew speaks out a few data link messages sent and received. After the flight, the data link recording and the CVR recording are compared for consistency.
  - (2) Retaining the most recent copy of the complete recording and the corresponding inspection report.

**GM2 CAT.GEN.MPA.195(b) Preservation, production and use of flight recorder recordings Handling of flight recorder recordings: preservation, production, protection and use**

MONITORING AND CHECKING THE PROPER OPERATION OF FLIGHT RECORDERS  
— EXPLANATION OF TERMS

For the understanding of the terms used in AMC1 CAT.GEN.MPA.195(b):

- (a) ‘operational check of the flight recorder’ means a check of the flight recorder for proper operation. It is not a check of the quality of the recording and, therefore, it is not equivalent to an inspection of the recording. This check can be carried out by the flight crew or through a maintenance task.

- (b) 'aural or visual means for preflight checking the flight recorders for proper operation' means an aural or visual means for the flight crew to check before the flight the results of an automatically or manually initiated test of the flight recorders for proper operation. Such a means provides for an operational check that can be performed by the flight crew. 'flight recorder system' means the flight recorder, its dedicated sensors and transducers, as well as its dedicated acquisition and processing equipment.
- (c) 'continuous monitoring for proper operation' means for a flight recorder system, a combination of system monitors and built-in test functions which operates continuously in order to detect the following:
- (1) loss of electrical power supply to the flight recorder system;
  - (2) failure of the equipment performing acquisition and processing;
  - (3) failure of the recording medium and/or drive mechanism; and
  - (4) failure of the recorder to store the data in the recording medium as shown by checks of the recorded data including, as reasonably practicable for the storage medium concerned, correct correspondence with the input data.

### **GM3 CAT.GEN.MPA.195(b) Handling of flight recorder recordings: preservation, production, protection and use**

#### **CVR AUDIO QUALITY**

Examples of CVR audio quality issues and possible causes thereof may be found in the document of the French Bureau d'Enquêtes et d'Analyses, titled 'Study on detection of audio anomalies on CVR recordings' and dated September 2015<sup>1</sup>.

### **AMC1 CAT.GEN.MPA.200(e) Transport of dangerous goods**

#### **DANGEROUS GOODS ACCIDENT AND INCIDENT REPORTING**

- (a) Any type of dangerous goods accident or incident, or the finding of undeclared or misdeclared dangerous goods should be reported, irrespective of whether the dangerous goods are contained in cargo, mail, passengers' baggage or crew baggage. For the purposes of the reporting of undeclared and misdeclared dangerous goods found in cargo, the Technical Instructions considers this to include items of operators' stores that are classified as dangerous goods.
- (b) The first report should be dispatched within 72 hours of the event. It may be sent by any means, including e-mail, telephone or fax. This report should include the details that are known at that time, under the headings identified in (c). If necessary, a subsequent report should be made as soon as possible giving all the details that were not known at the time the first report was sent. If a report has been made verbally, written confirmation should be sent as soon as possible.
- (c) The first and any subsequent report should be as precise as possible and should contain the following data, where relevant:
- (1) date of the incident or accident or the finding of undeclared or misdeclared dangerous goods;
  - (2) location, the flight number and flight date;
  - (3) description of the goods and the reference number of the air waybill, pouch, baggage tag, ticket, etc.;
  - (4) proper shipping name (including the technical name, if appropriate) and UN/ID number, when known;
  - (5) class or division and any subsidiary risk;
  - (6) type of packaging, and the packaging specification marking on it;
  - (7) quantity;
  - (8) name and address of the shipper, passenger, etc.;

- (9) any other relevant details;
  - (10) suspected cause of the incident or accident;
  - (11) action taken;
  - (12) any other reporting action taken; and
  - (13) name, title, address and telephone number of the person making the report.
- (d) Copies of relevant documents and any photographs taken should be attached to the report.
- (e) A dangerous goods accident or incident may also constitute an aircraft accident, serious incident or incident. Reports should be made for both types of occurrences when the criteria for each are met.
- (f) The following dangerous goods reporting form should be used, but other forms, including electronic transfer of data, may be used provided that at least the minimum information of this AMC is supplied:

## DANGEROUS GOODS OCCURRENCE REPORT DGOR No:

1. Operator:		2. Date of Occurrence:		3. Local time of occurrence:	
4. Flight date:			5. Flight No:		
6. Departure aerodrome:			7. Destination aerodrome:		
8. Aircraft type:			9. Aircraft registration:		
10. Location of occurrence:			11. Origin of the goods:		
12. Description of the occurrence, including details of injury, damage, etc. (if necessary, continue on the reverse of this form):					
13. Proper shipping name (including the technical name):				14. UN/ID No (when known):	
15. Class/Division (when known):		16. Subsidiary risk(s):	17. Packing group:	18. Category (Class 7 only):	
19. Type of packaging:		20. Packaging specification marking:	21. No of packages:	22. Quantity (or transport index, if applicable):	
23. Reference No of Airway Bill:					

## DANGEROUS GOODS OCCURRENCE REPORT DGOR No:

24. Reference No of courier pouch, baggage tag, or passenger ticket:	
25. Name and address of shipper, agent, passenger, etc.:	
26. Other relevant information (including suspected cause, any action taken):	
27. Name and Title of person making report	28. Telephone
29. Company	30. Reporters ref:
31. Address	32. Signature
	33. Date:
Description of the occurrence (continuation)	

*Notes for completion of the form:**N/A*

*This form should also be used to report any occasion when undeclared or misdeclared dangerous goods are discovered in cargo, mail or unaccompanied baggage or when accompanied baggage contains dangerous goods which passengers or crew are not permitted to take on aircraft.*

*The initial report should be dispatched unless exceptional circumstances prevent this. This occurrence report form, duly completed, should be sent as soon as possible, even if all the information is not available.*

*Copies of all relevant documents and any photographs taken should be attached to this report.*

*Any further information, or any information not included in the initial report, should be sent as soon as possible to the authorities identified in CAT.GEN.MPA.200(e).*

*Providing it is safe to do so, all dangerous goods, packaging, documents, etc., relating to the occurrence should be retained until after the initial report has been sent to the authorities identified in CAT.GEN.MPA.200(e) and they have indicated whether or not these should continue to be retained.*

**GM1 CAT.GEN.MPA.200 Transport of dangerous goods**

GENERAL

- (a) The requirement to transport dangerous goods by air in accordance with the Technical Instructions is irrespective of whether:
  - (1) the flight is wholly or partly within or wholly outside the territory of a State; or
  - (2) an approval to carry dangerous goods in accordance with Part- SPA, Subpart G is held.
- (b) The Technical Instructions provide that in certain circumstances dangerous goods, which are normally forbidden on an aircraft, may be carried. These circumstances include cases of extreme urgency or when other forms of transport are inappropriate or when full compliance with the prescribed requirements is contrary to the public interest. In these circumstances, all the States concerned may grant exemptions from the provisions of the Technical Instructions provided that an overall level of safety which is at least equivalent to that provided by the Technical Instructions is achieved. Although exemptions are most likely to be granted for the carriage of dangerous goods that are not permitted in normal circumstances, they may also be granted in other circumstances, such as when the packaging to be used is not provided for by the appropriate packing method or the quantity in the packaging is greater than that permitted. The Technical Instructions also make provision for some dangerous goods to be carried when an approval has been granted only by the State of origin and the State of the operator.
- (c) When an exemption is required, the States concerned are those of origin, transit, overflight and destination of the consignment and that of the operator. For the State of overflight, if none of the criteria for granting an exemption are relevant, an exemption may be granted based solely on whether it is believed that an equivalent level of safety in air transport has been achieved.
- (d) The Technical Instructions provide that exemptions and approvals are granted by the 'appropriate national authority', which is intended to be the authority responsible for the particular aspect against which the exemption or approval is being sought. The Instructions do not specify who should seek exemptions and, depending on the legislation of the particular State, this may mean the operator, the shipper or an agent. If an exemption or approval has been granted to other than the operator, the operator should ensure a copy has been obtained before the relevant flight. The operator should ensure all relevant conditions on an exemption or approval are met.
- (e) The exemption or approval referred to in (b) to (d) is in addition to the approval required by Part SPA, Subpart G.

## **SECTION 2 — Non-motor-powered aircraft**

Reserved

## SUBPART B — Operating procedures

### SECTION 1 — Motor-powered aircraft

#### GM1 CAT.OP.MPA.100(a)(2) Use of air traffic services

##### IN-FLIGHT OPERATIONAL INSTRUCTIONS

When coordination with an appropriate air traffic service (ATS) unit has not been possible, in-flight operational instructions do not relieve a commander of the responsibility for obtaining an appropriate clearance from an ATS unit, if applicable, before making a change in flight plan.

#### AMC1 CAT.OP.MPA.105 Use of aerodromes and operating sites

##### DEFINING OPERATING SITES — HELICOPTERS

When defining operating sites (including infrequent or temporary sites) for the type(s) of helicopter(s) and operation(s) concerned, the operator should take account of the following:

- (a) An adequate site is a site that the operator considers to be satisfactory, taking account of the applicable performance requirements and site characteristics (guidance on standards and criteria are contained in ICAO Annex 14 Volume 2 and in the ICAO *Heliport Manual* (Doc 9261-AN/903)).
- (b) The operator should have in place a procedure for the survey of sites by a competent person. Such a procedure should take account of possible changes to the site characteristics which may have taken place since last surveyed.
- (c) Sites that are pre-surveyed should be specifically specified in the operations manual. The operations manual should contain diagrams or/and ground and aerial photographs, and depiction (pictorial) and description of:
  - (1) the overall dimensions of the site;
  - (2) location and height of relevant obstacles to approach and take-off profiles, and in the manoeuvring area;
  - (3) approach and take-off flight paths;
  - (4) surface condition (blowing dust/snow/sand);
  - (5) helicopter types authorised with reference to performance requirements;
  - (6) provision of control of third parties on the ground (if applicable);
  - (7) procedure for activating site with land owner or controlling authority;
  - (8) other useful information, for example, appropriate ATS agency and frequency; and
  - (9) lighting (if applicable).
- (d) For sites that are not pre-surveyed, the operator should have in place a procedure that enables the pilot to make, from the air, a judgment on the suitability of a site. (c)(1) to (c)(6) should be considered.
- (e) Operations to non- pre-surveyed sites by night (except in accordance with SPA.HEMS.125 (b)(4)) should not be permitted.

#### AMC2 CAT.OP.MPA.105 Use of aerodromes and operating sites

##### HELIDECK



- (a) The content of Part C of the operations manual relating to the specific usage of helidecks should contain both the listing of helideck limitations in a helideck limitations list (HLL) and a pictorial representation (template) of each helideck showing all necessary information of a permanent nature. The HLL should show, and be amended as necessary to indicate, the most recent status of each helideck concerning non-compliance with ICAO Annex 14 Volume 2, limitations, warnings, cautions or other comments of operational importance. An example of a typical template is shown in Figure 1 below.
- (b) In order to ensure that the safety of flights is not compromised, the operator should obtain relevant information and details for compilation of the HLL, and the pictorial representation, from the owner/operator of the helideck.
- (c) When listing helidecks, if more than one name of the helideck exists, the most common name should be used and other names should also be included. After renaming a helideck, the old name should be included in the HLL for the ensuing 6 months.
- (d) All helideck limitations should be included in the HLL. Helidecks without limitations should also be listed. With complex installations and combinations of installations (e.g. co-locations), a separate listing in the HLL, accompanied by diagrams where necessary, may be required.
- (e) Each helideck should be assessed based on limitations, warnings, cautions or comments to determine its acceptability with respect to the following that, as a minimum, should cover the factors listed below:
  - (1) The physical characteristics of the helideck.
  - (2) The preservation of obstacle-protected surfaces is the most basic safeguard for all flights.

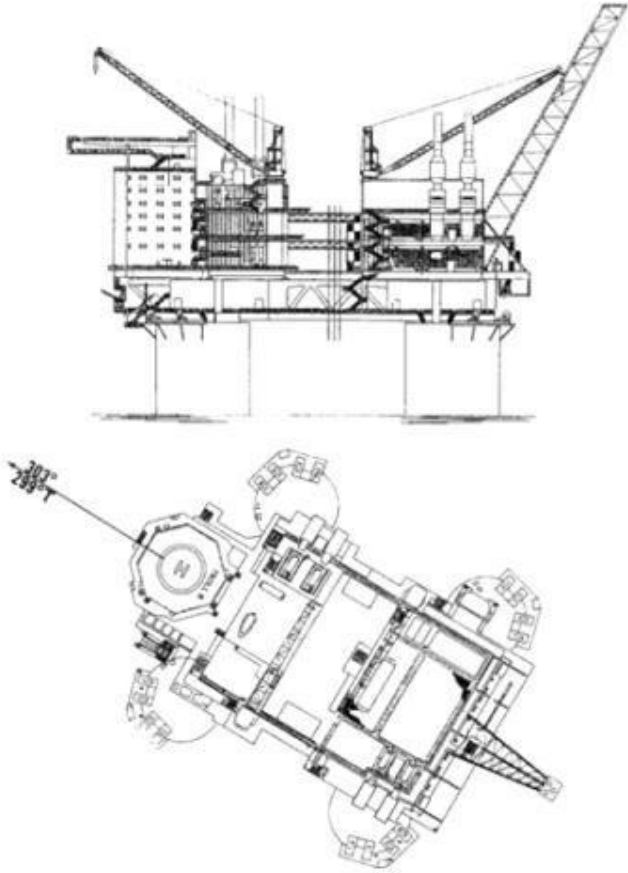
These surfaces are:

    - (i) the minimum 210° obstacle-free surface (OFS);
    - (ii) the 150° limited obstacle surface (LOS); and
    - (iii) the minimum 180° falling '5:1'-gradient with respect to significant obstacles. If this is infringed or if an adjacent installation or vessel infringes the obstacle clearance surfaces or criteria related to a helideck, an assessment should be made to determine any possible negative effect that may lead to operating restrictions.
  - (3) Marking and lighting:
    - (i) adequate perimeter lighting;
    - (ii) adequate floodlighting;
    - (iii) status lights (for night and day operations e.g. signalling lamp);
    - (iv) dominant obstacle paint schemes and lighting;
    - (v) helideck markings; and
    - (vi) general installation lighting levels. Any limitations in this respect should be annotated 'daylight only operations' on the HLL.
  - (4) Deck surface:
    - (i) surface friction;
    - (ii) helideck net;
    - (iii) drainage system;
    - (iv) deck edge netting;
    - (v) tie down system; and
    - (vi) cleaning of all contaminants.
  - (5) Environment:

- (i) foreign object damage;
  - (ii) physical turbulence generators;
  - (iii) bird control;
  - (iv) air quality degradation due to exhaust emissions, hot gas vents or cold gas vents; and
  - (v) adjacent helideck may need to be included in air quality assessment.
- (6) Rescue and fire fighting:
- (i) primary and complementary media types, quantities, capacity and systems personal protective equipment and clothing, breathing apparatus; and
  - (ii) crash box.
- (7) Communications & navigation:
- (i) aeronautical radio(s);
  - (ii) radio/telephone (R/T) call sign to match helideck name and side identification which should be simple and unique;
  - (iii) Non-directional beacon (NDB) or equivalent (as appropriate);
  - (iv) radio log; and
  - (v) light signal (e.g. signalling lamp).
- (8) Fuelling facilities: in accordance with the relevant national guidance and regulations.
- (9) Additional operational and handling equipment:
- (i) windsock;
  - (ii) wind recording;
  - (iii) deck motion recording and reporting where applicable;
  - (iv) passenger briefing system;
  - (v) chocks;
  - (vi) tie downs; and
  - (vii) weighing scales.
- (10) Personnel: trained helideck staff (e.g. helicopter landing officer/helicopter deck assistant and fire fighters, etc.).
- (11) Other: as appropriate.
- (f) For helidecks about which there is incomplete information, 'limited' usage based on the information available may be specified by the operator prior to the first helicopter visit. During subsequent operations and before any limit on usage is lifted, information should be gathered and the following should apply:
- (1) Pictorial (static) representation:
- (i) template (see figure 1) blanks should be available, to be filled out during flight preparation on the basis of the information given by the helideck owner/operator and flight crew observations;
  - (ii) where possible, suitably annotated photographs may be used until the HLL and template have been completed;
  - (iii) until the HLL and template have been completed, operational restrictions (e.g. performance, routing, etc.) may be applied;
  - (iv) any previous inspection reports should be obtained by the operator; and
  - (v) an inspection of the helideck should be carried out to verify the content of the completed HLL and template, following which the helideck may be considered as fully adequate for operations.

- (2) With reference to the above, the HLL should contain at least the following:
- (i) HLL revision date and number;
  - (ii) generic list of helideck motion limitations;
  - (iii) name of helideck;
  - (iv) 'D' value; and
  - (v) limitations, warnings, cautions and comments.
- (3) The template should contain at least the following (see example below):
- (i) installation/vessel name;
  - (ii) R/T call sign;
  - (iii) helideck identification marking;
  - (iv) side panel identification marking;
  - (v) helideck elevation;
  - (vi) maximum installation/vessel height;
  - (vii) 'D' value;
  - (viii) type of installation/vessel:
    - fixed manned
    - fixed unmanned
    - ship type (e.g. diving support vessel)
    - semi-submersible
    - jack-up
  - (ix) name of owner/operator;
  - (x) geographical position;
  - (xi) communication and navigation (Com/Nav) frequencies and ident;
  - (xii) general drawing preferably looking into the helideck with annotations showing location of derrick, masts, cranes, flare stack, turbine and gas exhausts, side identification panels, windsock, etc.;
  - (xiii) plan view drawing, chart orientation from the general drawing, to show the above. The plan view will also show the 210° orientation in degrees true;
  - (xiv) type of fuelling:
    - pressure and gravity
    - pressure only
    - gravity only
    - none
  - (xv) type and nature of fire fighting equipment;
  - (xvi) availability of ground power unit (GPU);
  - (xvii) deck heading;
  - (xviii) maximum allowable mass;
  - (xix) status light (Yes/No); and
  - (xx) revision date of publication.

Figure 1 — Helideck template

Installation/vessel name		R/T callsign: ...		Helideck identification	
Helideck elevation: 200 ft		Maximum height : 350 ft		Side identification : ...	
Type of installation : ... 1				D value :22 m	
Position : <sup>2</sup> N ... W ...				Operator <sup>3</sup>	
				ATIS: VHF 123.45	
COM	LOG : 123.45	VHF	NAV	NDB : 123 (ident)	
	Traffic: 123.45	VHF		DME : 123	
	Deck : 123.45	VHF		VOR/DME : 123	
				VOR : 123	
					
Fuelling : ... 4		GPU : ... 5		Deck heading : ...	

MTOM: ... T	Statuslight : ... 6	Fire fighting equipment : ... 7
		Revision date: ...

1 Fixed manned, fixed unmanned; ship type (e.g. diving support vessel); semi-submersible; jack-up.

2 WGS84 grid.

3 NAM, AMOCO, etc.

4 Pressure/gravity; pressure; gravity; no.

5 Yes; no; 28V DC.

6 Yes; no.

7 Type (e.g. aqueous film forming foams (AFFF)) and nature (e.g. deck integrated fire fighting system (DIFFs)).

## AMC1 CAT.OP.MPA.110 Aerodrome operating minima

### TAKE-OFF OPERATIONS — AEROPLANES

#### (a) General

- (1) Take-off minima should be expressed as visibility or runway visual range (RVR) limits, taking into account all relevant factors for each aerodrome planned to be used and aircraft characteristics. Where there is a specific need to see and avoid obstacles on departure and/or for a forced landing, additional conditions, e.g. ceiling, should be specified.
- (2) The commander should not commence take-off unless the weather conditions at the aerodrome of departure are equal to or better than applicable minima for landing at that aerodrome unless a weather-permissible take-off alternate aerodrome is available.
- (3) When the reported meteorological visibility (VIS) is below that required for take-off and RVR is not reported, a take-off should only be commenced if the commander can determine that the visibility along the take-off runway is equal to or better than the required minimum.
- (4) When no reported meteorological visibility or RVR is available, a take-off should only be commenced if the commander can determine that the visibility along the take-off runway is equal to or better than the required minimum.

#### (b) Visual reference

- (1) The take-off minima should be selected to ensure sufficient guidance to control the aircraft in the event of both a rejected take-off in adverse circumstances and a continued take-off after failure of the critical engine.
- (2) For night operations, ground lights should be available to illuminate the runway and any obstacles.

#### (c) Required RVR/VIS — aeroplanes

- (1) For multi-engined aeroplanes, with performance such that in the event of a critical engine failure at any point during take-off the aeroplane can either stop or continue the take-off to a height of 1 500 ft above the aerodrome while clearing obstacles by the required margins, the take-off minima specified by the operator should be expressed as RVR/CMV (converted meteorological visibility) values not lower than those specified in Table 1.A.

- (2) For multi-engined aeroplanes without the performance to comply with the conditions in (c)(1) in the event of a critical engine failure, there may be a need to re-land immediately and to see and avoid obstacles in the take-off area. Such aeroplanes may be operated to the following take-off minima provided they are able to comply with the applicable obstacle clearance criteria, assuming engine failure at the height specified. The take-off minima specified by the operator should be based upon the height from which the one-engine-inoperative (OEI) net take-off flight path can be constructed. The RVR minima used should not be lower than either of the values specified in Table 1.A or Table 2.A.
- (3) When RVR or meteorological visibility is not available, the commander should not commence take-off unless he/she can determine that the actual conditions satisfy the applicable take-off minima.

**Table 1.A:** Take-off — aeroplanes (without an approval for low visibility take-off (LVTO)) RVR/VIS

Facilities	RVR/VIS (m) *
Day only: Nil**	500
Day: at least runway edge lights or runway centerline markings Night: at least runway edge lights and runway end lights or runway centerline lights and runway end lights	400

\*: The reported RVR/VIS value representative of the initial part of the take-off run can be replaced by pilot assessment.

\*\* : The pilot is able to continuously identify the take-off surface and maintain directional control.

Table 2.A: Take-off— aeroplanes

Assumed engine failure height above the runway versus RVR/VIS

Assumed engine failure height above the take-off runway (ft)	RVR/VIS (m) **
<50	400 (200 with LVTO approval)
51 – 100	400 (300 with LVTO approval)
101 – 150	400
151 – 200	500
201 – 300	1 000
>300 *	1 500

\*: 1 500 m is also applicable if no positive take-off flight path can be constructed.

\*\* : The reported RVR/VIS value representative of the initial part of the take-off run can be replaced by pilot assessment.

## AMC2CAT.OP.MPA.110 Aerodrome operating minima

### TAKE-OFF OPERATIONS—HELICOPTERS

- (a) General

- (1) Take-off minima should be expressed as visibility or runway visual range (RVR) limits, taking into account all relevant factors for each aerodrome planned to be used and aircraft characteristics. Where there is a specific need to see and avoid obstacles on departure and/or for a forced landing, additional conditions, e.g. ceiling, should be specified.
  - (2) The commander should not commence take-off unless the weather conditions at the aerodrome of departure are equal to or better than applicable minima for landing at that aerodrome unless a weather-permissible take-off alternate aerodrome is available.
  - (3) When the reported meteorological visibility (VIS) is below that required for take-off and RVR is not reported, a take-off should only be commenced if the commander can determine that the visibility along the take-off runway/area is equal to or better than the required minimum.
  - (4) When no reported meteorological visibility or RVR is available, a take-off should only be commenced if the commander can determine that the visibility along the take-off runway/area is equal to or better than the required minimum.
- (b) Visual reference
- (1) The take-off minima should be selected to ensure sufficient guidance to control the aircraft in the event of both a rejected take-off in adverse circumstances and a continued take-off after failure of the critical engine.
  - (2) For night operations, ground lights should be available to illuminate the runway/final approach and take-off area (FATO) and any obstacles.
- (c) Required RVR/VIS — helicopters:
- (1) For performance class 1 operations, the operator should specify an RVR/VIS as take-off minima in accordance with Table 1.H.
  - (2) For performance class 2 operations onshore, the commander should operate to take-off minima of 800 m RVR/VIS and remain clear of cloud during the take-off manoeuvre until reaching performance class 1 capabilities.
  - (3) For performance class 2 operations offshore, the commander should operate to minima not less than that for performance class 1 and remain clear of cloud during the take-off manoeuvre until reaching performance class 1 capabilities.
  - (4) Table 8 for converting reported meteorological visibility to RVR should not be used for calculating take-off minima.

Table 1.H: Take-off — helicopters (without LVTO approval) RVR/VIS

Onshore aerodromes with instrument flight rules (IFR) departure procedures	RVR/VIS (m)
No light and no markings (day only)	400 or the rejected take-off distance, whichever is the greater
No markings (night)	800
Runway edge/FATO light and centreline marking	400
Runway edge/FATO light, centreline marking and relevant RVR information	400
Offshore helideck*	
Two-pilot operations	400
Single-pilot operations	500

\*: The take-off flight path to be free of obstacles.

### **AMC3 CAT.OP.MPA.110 Aerodrome operating minima**

#### **NPA, APV, CAT I OPERATIONS**

- (a) The decision height (DH) to be used for a non-precision approach (NPA) flown with the continuous descent final approach (CDFA) technique, approach procedure with vertical guidance (APV) or category (CAT) I operation should not be lower than the highest of:
- (1) the minimum height to which the approach aid can be used without the required visual reference;
  - (2) the obstacle clearance height (OCH) for the category of aircraft;
  - (3) the published approach procedure DH where applicable;
  - (4) the system minimum specified in Table 3; or
  - (5) the minimum DH specified in the aircraft flight manual (AFM) or equivalent document, if stated.
- (b) The minimum descent height (MDH) for an NPA operation flown without the CDFA technique should not be lower than the highest of:
- (1) The OCH for the category of aircraft;
  - (2) the system minimum specified in Table 3; or
  - (3) the minimum MDH specified in the AFM, if stated.



Table 3: System minima

Facility	Lowest DH/MDH (ft)
ILS / MLS / GLS	200
GNSS / SBAS (LPV)	200
GNSS (LNAV)	250
GNSS / Baro VNAV (LNAV / VNAV)	250
LOC with or without DME	250
SRA (terminating at ½ NM)	250
SRA (terminating at 1 NM)	300
SRA (terminating at 2 NM)	350
VOR	300
VOR/DME	250
NDB	350
NDB/DME	300
VDF	350

*DME: distance measuring equipment;*

*GNSS: global navigation satellite system;*

*ILS: instrument landing system;*

*LNAV: lateral navigation;*

*LOC: localiser;*

*LPV: localiser performance with vertical guidance*

*SBAS: satellite-based augmentation system;*

*SRA: surveillance radar approach;*

*VDF: VHF direction finder;*

*VNAV: vertical navigation;*

*VOR: VHF omnidirectional radio range.*

#### **AMC4 CAT.OP.MPA.110 Aerodrome operating minima**

##### CRITERIA FOR ESTABLISHING RVR/CMV

###### (a) Aeroplanes

The following criteria for establishing RVR/CMV should apply:

- (1) In order to qualify for the lowest allowable values of RVR/CMV specified in Table 6.A, the instrument approach should meet at least the following facility specifications and associated conditions:
  - (i) Instrument approaches with designated vertical profile up to and including 4.5° for category A and B aeroplanes, or 3.77° for category C and D aeroplanes where the facilities are:
    - (A) ILS/microwave landing system (MLS)/GBAS landing system (GLS)/precision approach radar (PAR); or
    - (B) APV; and
 where the final approach track is offset by not more than 15° for category A and B aeroplanes or by not more than 5° for category C and D aeroplanes.

- (ii) Instrument approach operations flown using the CDFA technique with a nominal vertical profile, up to and including 4.5° for category A and B aeroplanes, or 3.77° for category C and D aeroplanes, where the facilities are NDB, NDB/DME, VOR, VOR/DME, LOC, LOC/DME, VDF, SRA or GNSS/LNAV, with a final approach segment of at least 3 NM, which also fulfil the following criteria:
    - (A) the final approach track is offset by not more than 15° for category A and B aeroplanes or by not more than 5° for category C and D aeroplanes;
    - (B) the final approach fix (FAF) or another appropriate fix where descent is initiated is available, or distance to threshold (THR) is available by flight management system/GNSS (FMS/GNSS) or DME; and
    - (C) if the missed approach point (MAPt) is determined by timing, the distance from FAF or another appropriate fix to THR is  $\leq 8$  NM.
  - (iii) Instrument approaches where the facilities are NDB, NDB/DME, VOR, VOR/DME, LOC, LOC/DME, VDF, SRA or GNSS/LNAV, not fulfilling the criteria in (a)(1)(ii), or with an MDH  $\geq 1\ 200$  ft.
- (2) The missed approach operation, after an approach operation has been flown using the CDFA technique, should be executed when reaching the DA/H or the MAPt, whichever occurs first. The lateral part of the missed approach procedure should be flown via the MAPt unless otherwise stated on the approach chart.

### **AMC5 CAT.OP.MPA.110 Aerodrome operating minima**

#### **DETERMINATION OF RVR/CMV/VIS MINIMA FOR NPA, APV, CAT I — AEROPLANES**

##### **(a) Aeroplanes**

The RVR/CMV/VIS minima for NPA, APV and CAT I operations should be determined as follows:

- (1) The minimum RVR/CMV/VIS should be the highest of the values specified in Table 5 or Table 6.A, but not greater than the maximum values specified in Table 6.A, where applicable.
- (2) The values in Table 5 should be derived from the formula below,  

$$\text{Required RVR/VIS (m)} = [(\text{DH/MDH (ft)} \times 0.3048) / \tan \alpha] \text{ — length of approach lights (m)}$$
 where  $\alpha$  is the calculation angle, being a default value of 3.00° increasing in steps of 0.10° for each line in Table 5 up to 3.77° and then remaining constant.
- (3) If the approach is flown with a level flight segment at or above MDA/H, 200 m should be added for category A and B aeroplanes and 400 m for category C and D aeroplanes to the minimum RVR/CMV/VIS value resulting from the application of Tables 5 and 6.A.
- (4) An RVR of less than 750 m as indicated in Table 5 may be used:
  - (i) for CAT I operations to runways with full approach lighting system (FALS), runway touchdown zone lights (RTZL) and runway centreline lights (RCLL);
  - (ii) for CAT I operations to runways without RTZL and RCLL when using an approved head-up guidance landing system (HUDLS), or equivalent approved system, or when conducting a coupled approach or flight-director-flown approach to a DH. The ILS should not be published as a restricted facility; and

- (iii) for APV operations to runways with FALS, RTZL and RCLL when using an approved head-up display (HUD).
- (5) Lower values than those specified in Table 5, for HUDLS and auto-land operations may be used if approved in accordance with Part-SPA, Subpart E (SPA.LVO).
- (6) The visual aids should comprise standard runway day markings and approach and runway lights as specified in Table 4. The LyCAA may approve that RVR values relevant to a basic approach lighting system (BALS) are used on runways where the approach lights are restricted in length below 210 m due to terrain or water, but where at least one cross-bar is available.
- (7) For night operations or for any operation where credit for runway and approach lights is required, the lights should be on and serviceable except as provided for in Table 9.
- (8) For single- pilot operations, the minimum RVR/VIS should be calculated in accordance with the following additional criteria:
  - (i) an RVR of less than 800 m as indicated in Table 5 may be used for CAT I approaches provided any of the following is used at least down to the applicable DH:
    - (A) a suitable autopilot, coupled to an ILS, MLS or GLS that is not published as restricted; or
    - (B) an approved HUDLS, including, where appropriate, enhanced vision system(EVS), or equivalent approved system;
  - (ii) where RTZL and/or RCLL are not available, the minimum RVR/CMV should not be less than 600 m; and
  - (iii) an RVR of less than 800 m as indicated in Table 5 may be used for APV operations to runways with FALS, RTZL and RCLL when using an approved HUDLS, or equivalent approved system, or when conducting a coupled approach to a DH equal to or greater than 250ft.

Table 4: Approach lighting systems

Class of lighting facility	Length, configuration and intensity of approach lights
FALS	CAT I lighting system (HIALS $\geq 720$ m) distance coded centreline, Barrette centreline
IALS	Simple approach lighting system (HIALS 420 – 719 m) single source, Barrette
BALS	Any other approach lighting system (HIALS, MALS or ALS 210 - 419 m)
NALS	Any other approach lighting system (HIALS, MALS or ALS <210 m) or no approach lights

*Note:*

*HIALS: high intensity approach lighting system;*

*MALS: medium intensity approach lighting system.*

**Table 5:** RVR/CMV vs DH/MDH

DH or MDH			Class of lighting facility			
			FALS	IALS	BALS	NALS
			See (a)(4),(5),(8) above for RVR <750/800 m			
ft			RVR/CMV (m)			
200		210	550	750	1 000	1 200
211		220	550	800	1 000	1 200
221		230	550	800	1 000	1 200
231		240	550	800	1 000	1 200
241		250	550	800	1 000	1 300
251		260	600	800	1 100	1 300
261		280	600	900	1 100	1 300
281	-	300	650	900	1 200	1 400
301	-	320	700	1 000	1 200	1 400
321	-	340	800	1 100	1 300	1 500
341	-	360	900	1 200	1 400	1 600
361	-	380	1 000	1 300	1 500	1 700
381	-	400	1 100	1 400	1 600	1 800
401	-	420	1 200	1 500	1 700	1 900
421	-	440	1 300	1 600	1 800	2 000
441	-	460	1 400	1 700	1 900	2 100
461	-	480	1 500	1 800	2 000	2 200
481		500	1 500	1 800	2 100	2 300
501	-	520	1 600	1 900	2 100	2 400
521	-	540	1 700	2 000	2 200	2 400

541	-	560	1 800	2 100	2 300	2 500
561	-	580	1 900	2 200	2 400	2 600
581	-	600	2 000	2 300	2 500	2 700
601	-	620	2 100	2 400	2 600	2 800
621	-	640	2 200	2 500	2 700	2 900
641	-	660	2 300	2 600	2 800	3 000
661	-	680	2 400	2 700	2 900	3 100
681	-	700	2 500	2 800	3 000	3 200
701	-	720	2 600	2 900	3 100	3 300
721	-	740	2 700	3 000	3 200	3 400
741	-	760	2 700	3 000	3 300	3 500
761	-	800	2 900	3 200	3 400	3 600
801	-	850	3 100	3 400	3 600	3 800
851	-	900	3 300	3 600	3 800	4 000
901	-	950	3 600	3 900	4 100	4 300
951	-	1 000	3 800	4 100	4 300	4 500
1 001	-	1 100	4 100	4 400	4 600	4 900
1 101	-	1 200	4 600	4 900	5 000	5 000
1 201 and above			5 000	5 000	5 000	5 000

**Table 6.A: CAT I, APV, NPA — aeroplanes**  
Minimum and maximum applicable RVR/CMV (lower and upper cut-off limits)

Facility/conditions	RVR/CMV (m)	Aeroplane category			
		A	B	C	D
ILS, MLS, GLS, PAR, GNSS/SBAS, GNSS/VNAV	Min	According to Table 5			
	Max	1 500	1 500	2 400	2 400
NDB, NDB/DME, VOR, VOR/DME, LOC, LOC/DME, VDF, SRA, GNSS/LNAV With a procedure that fulfills the criteria in AMC4 CAT.OP.MPA.110, (a)(1)(ii)	Min	750	750	750	750
	Max	1 500	1 500	2 400	2 400
For NDB, NDB/DME, VOR, VOR/DME, LOC, LOC/DME, VDF, SRA, GNSS/LNAV: — not fulfilling the criteria in in AMC4 CAT.OP.MPA.110, (a)(1)(ii), or — with a DH or MDH $\geq 1\ 200$ ft	Min	1 000	1 000	1 200	1 200
	Max	According to Table 5, if flown using the CDFA technique, otherwise an add-on of 200 m for Category A and B aeroplanes and 400 m for Category C and D aeroplanes applies to the values in Table 5 but not to result in a value exceeding 5 000 m.			

### AMC6 CAT.OP.MPA.110 Aerodrome operating minima

#### DETERMINATION OF RVR/CMV/VIS MINIMA FOR NPA, CAT I — HELICOPTERS

(a) Helicopters

The RVR/CMV/VIS minima for NPA, APV and CAT I operations should be determined as follows:

- (1) For NPA operations operated in performance class 1 (PC1) or performance class 2 (PC2), the minima specified in Table 6.1.H should apply:
  - (i) where the missed approach point is within  $\frac{1}{2}$  NM of the landing threshold, the approach minima specified for FALS may be used regardless of the length of approach lights available. However, FATO/runway edge lights, threshold lights, end lights and FATO/runway markings are still required;
  - (ii) for night operations, ground lights should be available to illuminate the FATO/runway and any obstacles; and

- (iii) for single-pilot operations, the minimum RVR is 800 m or the minima in Table 6.1.H, whichever is higher.
- (2) For CAT I operations operated in PC1 or PC2, the minima specified in Table 6.2.H should apply:
  - (i) for night operations, ground light should be available to illuminate the FATO/runway and any obstacles;
  - (ii) for single-pilot operations, the minimum RVR/VIS should be calculated in accordance with the following additional criteria:
    - (A) an RVR of less than 800 m should not be used except when using a suitable autopilot coupled to an ILS, MLS or GLS, in which case normal minima apply; and
    - (B) the DH applied should not be less than 1.25 times the minimum use height for the autopilot.

**Table 6.1.H: Onshore NPA minima**

MDH (ft)	Facilities vs RVR/CMV (m) **, ***			
	FALS	IALS	BALS	NALS
250 – 299	600	800	1 000	1 000
300 – 449	800	1 000	1 000	1 000
450 and above	1 000	1 000	1 000	1 000

\*: The MDH refers to the initial calculation of MDH. When selecting the associated RVR, there is no need to take account of a rounding up to the nearest 10 ft, which may be done for operational purposes, e.g. conversion to MDA.

\*\* : The tables are only applicable to conventional approaches with a nominal descent slope of not greater than 4°. Greater descent slopes will usually require that visual glide slope guidance (e.g. precision approach path indicator (PAPI)) is also visible at the MDH.

\*\*\*: FALS comprise FATO/runway markings, 720 m or more of high intensity/medium intensity (HI/MI) approach lights, FATO/runway edge lights, threshold lights and FATO/runway end lights. Lights to be on.

IALS comprise FATO/runway markings, 420 - 719 m of HI/ MI approach lights, FATO/runway edge lights, threshold lights and FATO/runway end lights. Lights to be on.

BALS comprise FATO/runway markings, <420 m of HI/ MI approach lights, any length of low intensity (LI) approach lights, FATO/runway edge lights, threshold lights and FATO/runway end lights. Lights to be on.

NALS comprise FATO/runway markings, FATO/runway edge lights, threshold lights, FATO/runway end lights or no lights at all.

Table 6.2.H: Onshore CAT I minima

DH (ft) *	Facilities vs RVR/CMV (m) **, ***			
	FALS	IALS	BALS	NALS
200	500	600	700	1 000
201 – 250	550	650	750	1 000
251 – 300	600	700	800	1 000
301 and above	750	800	900	1 000

\*: The DH refers to the initial calculation of DH. When selecting the associated RVR, there is no need to take account of a rounding up to the nearest 10 ft, which may be done for operational purposes, e.g. conversion to DA .

\*\*.: The table is applicable to conventional approaches with a glide slope up to and including 4°.

\*\*\*.: FALS comprise FATO/runway markings, 720 m or more of HI/MI approach lights, FATO/runway edge lights, threshold lights and FATO/runway end lights. Lights to be on.

IALS comprise FATO/runway markings, 420 - 719 m of HI/ MI approach lights, FATO/runway edge lights, threshold lights and FATO/runway end lights. Lights to be on.

BALS comprise FATO/runway markings, <420 m of HI/ MI approach lights, any length of LI approach lights, FATO/runway edge lights, threshold lights and FATO/runway end lights. Lights to be on.

NALS comprise FATO/runway markings, FATO/runway edge lights, threshold lights, FATO/runway end lights or no lights at all.

## AMC7 CAT.OP.MPA.110 Aerodrome operating minima

### CIRCLING OPERATIONS — AEROPLANES

#### (a) Circling minima

The following standards should apply for establishing circling minima for operations with aeroplanes:

- (1) the MDH for circling operation should not be lower than the highest of:
  - (i) the published circling OCH for the aeroplane category;
  - (ii) the minimum circling height derived from Table 7; or
  - (iii) the DH/MDH of the preceding instrument approach procedure;
- (2) the MDA for circling should be calculated by adding the published aerodrome elevation to the MDH, as determined by (a)(1); and
- (3) the minimum visibility for circling should be the highest of:
  - (i) the circling visibility for the aeroplane category, if published
  - (ii) the minimum visibility derived from Table 7; or
  - (iii) the RVR/CMV derived from Tables 5 and 6.A for the preceding instrument approach procedure



**Table 7:** Circling — aeroplanes  
MDH and minimum visibility vs aeroplane category

	Aeroplane category			
	A	B	C	D
MDH (ft)	400	500	600	700
Minimum meteorological visibility (m)	1 500	1 600	2 400	3 600

- (b) Conduct of flight — general:
- (1) the MDH and OCH included in the procedure are referenced to aerodrome elevation;
  - (2) the MDA is referenced to mean sea level;
  - (3) for these procedures, the applicable visibility is the meteorological visibility; and
  - (4) operators should provide tabular guidance of the relationship between height above threshold and the in-flight visibility required to obtain and sustain visual contact during the circling manoeuvre.
- (c) Instrument approach followed by visual manoeuvring (circling) without prescribed tracks
- (1) When the aeroplane is on the initial instrument approach, before visual reference is stabilised, but not below MDA/H, the aeroplane should follow the corresponding instrument approach procedure until the appropriate instrument MAPt is reached.
  - (2) At the beginning of the level flight phase at or above the MDA/H, the instrument approach track determined by radio navigation aids, RNAV, RNP, ILS, MLS or GLS should be maintained until the pilot:
    - (i) estimates that, in all probability, visual contact with the runway of intended landing or the runway environment will be maintained during the entire circling procedure;
    - (ii) estimates that the aeroplane is within the circling area before commencing circling; and
    - (iii) is able to determine the aeroplane's position in relation to the runway of intended landing with the aid of the appropriate external references.
  - (3) When reaching the published instrument MAPt and the conditions stipulated in (c)(2) are unable to be established by the pilot, a missed approach should be carried out in accordance with that instrument approach procedure.

- (4) After the aeroplane has left the track of the initial instrument approach, the flight phase outbound from the runway should be limited to an appropriate distance, which is required to align the aeroplane onto the final approach. Such manoeuvres should be conducted to enable the aeroplane:
  - (i) to attain a controlled and stable descent path to the intended landing runway; and
  - (ii) to remain within the circling area and in such way that visual contact with the runway of intended landing or runway environment is maintained at all times.
- (5) Flight manoeuvres should be carried out at an altitude/height that is not less than the circling MDA/H.
- (6) Descent below MDA/H should not be initiated until the threshold of the runway to be used has been appropriately identified. The aeroplane should be in a position to continue with a normal rate of descent and land within the touchdown zone.
- (d) Instrument approach followed by a visual manoeuvring (circling) with prescribed track
  - (1) The aeroplane should remain on the initial instrument approach procedure until one of the following is reached:
    - (i) the prescribed divergence point to commence circling on the prescribed track; or
    - (ii) MAPt.
  - (2) The aeroplane should be established on the instrument approach track determined by the radio navigation aids, RNAV, RNP, ILS, MLS or GLS in level flight at or above the MDA/H at or by the circling manoeuvre divergence point.
  - (3) If the divergence point is reached before the required visual reference is acquired, a missed approach should be initiated not later than the MAPt and completed in accordance with the instrument approach procedure.
  - (4) When commencing the prescribed circling manoeuvre at the published divergence point, the subsequent manoeuvres should be conducted to comply with the published routing and published heights/altitudes.
  - (5) Unless otherwise specified, once the aeroplane is established on the prescribed track(s), the published visual reference does not need to be maintained unless:
    - (i) required by the State of the aerodrome; or
    - (ii) the circling MAPt (if published) is reached.
  - (6) If the prescribed circling manoeuvre has a published MAPt and the required visual reference has not been obtained by that point, a missed approach should be executed in accordance with (e)(2) and (e)(3).
  - (7) Subsequent further descent below MDA/H should only commence when the required visual reference has been obtained.
  - (8) Unless otherwise specified in the procedure, final descent should not be commenced from MDA/H until the threshold of the intended landing runway has been identified and the aeroplane is in a position to continue with a normal rate of descent to land within the touchdown zone.
- (e) Missed approach
  - (1) Missed approach during the instrument procedure prior to circling:

- (i) if the missed approach procedure is required to be flown when the aeroplane is positioned on the instrument approach track defined by radio- navigation aids RNAV, RNP, or ILS, MLS, and before commencing the circling manoeuvre, the published missed approach for the instrument approach should be followed; or
  - (ii) if the instrument approach procedure is carried out with the aid of an ILS, MLS or an stabilised approach (SAp), the MAPt associated with an ILS, MLS procedure without glide path (GP-out procedure) or the SAp, where applicable, should be used.
- (2) If a prescribed missed approach is published for the circling manoeuvre, this overrides the manoeuvres prescribed below.
- (3) If visual reference is lost while circling to land after the aeroplane has departed from the initial instrument approach track, the missed approach specified for that particular instrument approach should be followed. It is expected that the pilot will make an initial climbing turn toward the intended landing runway to a position overhead the aerodrome where the pilot will establish the aeroplane in a climb on the instrument missed approach segment.
- (4) The aeroplane should not leave the visual manoeuvring (circling) area, which is obstacle-protected, unless:
- (i) established on the appropriate missed approach procedure; or
  - (ii) at minimum sector altitude (MSA).
- (5) All turns should be made in the same direction and the aeroplane should remain within the circling protected area while climbing either:
- (i) to the altitude assigned to any published circling missed approach manoeuvre if applicable;
  - (ii) to the altitude assigned to the missed approach of the initial instrument approach;
  - (iii) to the MSA; or
  - (iv) to the minimum holding altitude (MHA) applicable to transition to a holding facility or fix, or continue to climb to an MSA;
- or as directed by ATS.

When the missed approach procedure is commenced on the 'downwind' leg of the circling manoeuvre, an 'S' turn may be undertaken to align the aeroplane on the initial instrument approach missed approach path, provided the aeroplane remains within the protected circling area.

The commander should be responsible for ensuring adequate terrain clearance during the above-stipulated manoeuvres, particularly during the execution of a missed approach initiated by ATS.

- (6) Because the circling manoeuvre may be accomplished in more than one direction, different patterns will be required to establish the aeroplane on the prescribed missed approach course depending on its position at the time visual reference is lost. In particular, all turns are to be in the prescribed direction if this is restricted, e.g. to the west/east (left or right hand) to remain within the protected circling area.
- (7) If a missed approach procedure is published for a particular runway onto which the aeroplane is conducting a circling approach and the aeroplane has commenced a manoeuvre to align with the runway, the missed approach for this direction may be accomplished. The ATS unit should be informed of the intention to fly the published missed approach procedure for that particular runway.

- (8) The commander should advise ATS when any missed approach procedure has been commenced, the height/altitude the aeroplane is climbing to and the position the aeroplane is proceeding towards and/or heading the aeroplane is established on.

### **AMC8 CAT.OP.MPA.110 Aerodrome operating minima**

#### ONSHORE CIRCLING OPERATIONS — HELICOPTERS

For circling, the specified MDH should not be less than 250 ft, and the meteorological visibility not less than 800 m.

### **AMC9 CAT.OP.MPA.110 Aerodrome operating minima**

#### VISUAL APPROACH OPERATIONS

The operator should not use an RVR of less than 800 m for a visual approach operation.

### **AMC10 CAT.OP.MPA.110 Aerodrome operating minima**

#### CONVERSION OF REPORTED METEOROLOGICAL VISIBILITY TO RVR

- (a) A conversion from meteorological visibility to RVR/CMV should not be used:
- (1) when reported RVR is available;
  - (2) for calculating take-off minima; and
  - (3) for any RVR minima less than 800 m.
- (b) If the RVR is reported as being above the maximum value assessed by the aerodrome operator, e.g. 'RVR more than 1 500 m', it should not be considered as a reported value for (a)(1).
- (c) When converting meteorological visibility to RVR in circumstances other than those in (a), the conversion factors specified in Table 8 should be used.

**Table 8:** Conversion of reported meteorological visibility to RVR/CMV

Light elements in operation	RVR/CMV = reported meteorological visibility x	
	Day	Night
HI approach and runway lights	1.5	2.0
Any type of light installation other than above	1.0	1.5
No lights	1.0	not applicable

### **AMC11 CAT.OP.MPA.110 Aerodrome operating minima**

#### EFFECT ON LANDING MINIMA OF TEMPORARILY FAILED OR DOWNGRADED GROUND EQUIPMENT

- (a) General
- These instructions are intended for use both pre-flight and in-flight. It is, however, not expected that the commander would consult such instructions after passing 1 000 ft above the aerodrome. If failures of ground aids are announced at such a late stage, the approach could be continued at the commander's discretion. If failures are announced before such a late stage in the approach, their effect on the approach should be considered as described in Table 9, and the approach may have to be abandoned.
- (b) Conditions applicable to Table 9:

- (1) multiple failures of runway/FATO lights other than indicated in Table 9 should not be acceptable;
- (2) deficiencies of approach and runway/FATO lights are treated separately; and
- (3) failures other than ILS, MLS affect RVR only and not DH.

**Table 9:** Failed or downgraded equipment — effect on landing minima Operations without a low visibility operations (LVO) approval

Failed or downgraded equipment	Effect on landing minima	
	CAT I	APV, NPA
ILS/MLS stand-by transmitter	No effect	
OuterMarker	Not allowed except if replaced by height check at 1 000 ft	APV — not applicable
		NPA with FAF: no effect unless used as FAF
		If the FAF cannot be identified (e.g. no method available for timing of descent), non-precision operations cannot be conducted
Middle marker	No effect	No effect unless used as MAPt
Failed or downgraded equipment	Effect on landing minima	
	CAT I	APV, NPA
RVR Assessment Systems	No effect	
Approachlights	Minima as for NALS	
Approach lights except the last 210 m	Minima as for BALS	
Approach lights except the last 420 m	Minima as for IALS	
Standby power for approach lights	No effect	
Edge lights, threshold lights and runway end lights	Day: no effect; Night: not allowed	
Centreline lights	No effect if F/D, HUDLS or auto-land  otherwise RVR 750 m	No effect

Centreline lights spacing increased to 30 m	No effect	
Touchdown zone lights	No effect if F/D, HUDLS or auto- land; otherwise RVR 750 m	No effect
Taxiway lighting system	No effect	

**AMC12 CAT.OP.MPA.110 Aerodrome operating minima**

VFR OPERATIONS WITH OTHER- THAN-COMPLEX MOTOR-POWERED AIRCRAFT

For the establishment of VFR operation minima, the operator may apply the VFR operating minima specified in Part-SERA. Where necessary, the operator may specify in the OM additional conditions for the applicability of such minima taking into account such factors as radio coverage, terrain, nature of sites for take-off and landing, flight conditions and ATS capacity.

**GM1 CAT.OP.MPA.110 Aerodrome operating minima**

ONSHORE AERODROME DEPARTURE PROCEDURES — HELICOPTERS

The cloud base and visibility should be such as to allow the helicopter to be clear of cloud at take-off decision point (TDP), and for the pilot flying to remain in sight of the surface until reaching the minimum speed for flight in instrument meteorological conditions (IMC) given in the AFM.

**GM2 CAT.OP.MPA.110 Aerodrome operating minima**

APPROACH LIGHTING SYSTEMS — ICAO, FAA

The following table provides a comparison of ICAO and FAA specifications.

**Table 1:** Approach lighting systems

Class of lighting facility	Length, configuration and intensity of approach lights
FALS	ICAO: CAT I lighting system (HIALS ≥ 900 m) distance coded centreline, Barrette centreline FAA: ALSF1, ALSF2, SSALR, MALSR, high or medium intensity and/or flashing lights, 720 m or more
IALS	ICAO: simple approach lighting system (HIALS 420 – 719 m) single source, Barrette FAA: MALSF, MALS, SALS/SALSF, SSALF, SSALS, high or medium intensity and/or flashing lights, 420 – 719 m
BALS	Any other approach lighting system (HIALS, MALS or ALS 210-419 m) FAA: ODALS, high or medium intensity or flashing lights 210 - 419 m

NALS	Any other approach lighting system (HIALS, MALS or ALS <210 m) or no approach lights
------	--

*Note:*

*ALSF: approach lighting system with sequenced flashing lights;*

*MALS: medium intensity approach lighting system;*

*MALSF: medium intensity approach lighting system with sequenced flashing lights;*

*MALSR: medium intensity approach lighting system with runway alignment indicator lights;*

*ODALS: omnidirectional approach lighting system; SALS: simple approach lighting system;*

*SALSF: short approach lighting system with sequenced flashing lights;*

*SSALF: simplified short approach lighting system with sequenced flashing lights;*

*SSALR: simplified short approach lighting system with runway alignment indicator lights;*

*SSALS: simplified short approach lighting system.*

### **GM3 CAT.OP.MPA.110 Aerodrome operating minima**

#### **SBAS OPERATIONS**

- (a) SBAS CAT I operations with a DH of 200 ft depend on an SBAS system approved for operations down to a DH of 200 ft.
- (b) The following systems are in operational use or in a planning phase:
  - (1) European geostationary navigation overlay service (EGNOS) operational in Europe;
  - (2) wide area augmentation system(WAAS) operational in the USA;
  - (3) multi- functional satellite augmentation system(MSAS) operational in Japan;
  - (4) system of differential correction and monitoring (SDCM) planned by Russia;
  - (5) GPS aided geo augmented navigation (GAGAN) system, planned by India; and
  - (6) satellite navigation augmentation system(SNAS), planned by China.

### **GM1 CAT.OP.MPA.110(a) Aerodrome operating minima**

#### **INCREMENTS SPECIFIED BY THE LyCAA**

Additional increments to the published minima may be specified by the LyCAA to take into account certain operations, such as downwind approaches and single-pilot operations.

### **AMC1 CAT.OP.MPA.115 Approach flight technique — aeroplanes**

#### **CONTINUOUS DESCENT FINAL APPROACH (CDFA)**

- (a) Flight techniques:
  - (1) The CDFA technique should ensure that an approach can be flown on the desired vertical path and track in a stabilised manner, without significant vertical path changes during the final segment descent to the runway. This technique applies to an approach with no vertical guidance and controls the descent path until the DA/DH. This descent path can be either:
    - (i) a recommended descent rate, based on estimated ground speed;
    - (ii) a descent path depicted on the approach chart; or

- (iii) a descent path coded in the flight management system in accordance with the approach chart descent path.
  - (2) The operator should either provide charts which depict the appropriate cross check altitudes/heights with the corresponding appropriate range information, or such information should be calculated and provided to the flight crew in an appropriate and usable format. Generally, the MAPt is published on the chart.
  - (3) The approach should be flown as an SAp.
  - (4) The required descent path should be flown to the DA/H, observing any step-down crossing altitudes if applicable.
  - (5) This DA/H should take into account any add-on to the published minima as identified by the operator's management system and should be specified in the OM (aerodrome operating minima).
  - (6) During the descent, the pilot monitoring should announce crossing altitudes as published fixes and other designated points are crossed, giving the appropriate altitude or height for the appropriate range as depicted on the chart. The pilot flying should promptly adjust the rate of descent as appropriate.
  - (7) The operator should establish a procedure to ensure that an appropriate callout is made when the aeroplane is approaching DA/H. If the required visual references are not established at DA/H, the missed approach procedure is to be executed promptly.
  - (8) The descent path should ensure that little or no adjustment of attitude or thrust/power is needed after the DA/H to continue the landing in the visual segment.
  - (9) The missed approach should be initiated no later than reaching the MAPt or at the DA/H, whichever comes first. The lateral part of the missed approach should be flown via the MAPt unless otherwise stated on the approach chart.
- (b) Flight techniques conditions:
- (1) The approach should be considered to be fully stabilised when the aeroplane is:
    - (i) tracking on the required approach path and profile;
    - (ii) in the required configuration and attitude;
    - (iii) flying with the required rate of descent and speed; and
    - (iv) flying with the appropriate thrust/power and trim.
  - (2) The aeroplane is considered established on the required approach path at the appropriate energy for stable flight using the CDFA technique when:
    - (i) it is tracking on the required approach path with the correct track set, approach aids tuned and identified as appropriate to the approach type flown and on the required vertical profile; and
    - (ii) it is at the appropriate attitude and speed for the required target rate of descent (ROD) with the appropriate thrust/power and trim.
  - (3) Stabilisation during any straight-in approach without visual reference to the ground should be achieved at the latest when passing 1 000 ft above runway threshold elevation. For approaches with a designated vertical profile applying the CDFA technique, a later stabilisation in speed may be acceptable if higher than normal approach speeds are required by ATC procedures or allowed by the OM. Stabilisation should, however, be achieved not later than 500 ft above runway threshold elevation.



- (4) For approaches where the pilot has visual reference with the ground, stabilisation should be achieved not later than 500 ft above aerodrome elevation. However, the aeroplane should be stabilised when passing 1 000 ft above runway threshold elevation; in the case of circling approaches flown after a CDFA, the aircraft should be stabilised in the circling configuration not later than passing 1 000 ft above the runway elevation.
- (5) To ensure that the approach can be flown in a stabilised manner, the bank angle, rate of descent and thrust/power management should meet the following performances:
- (i) The bank angle should be less than 30 degrees.
  - (ii) The target rate of descent (ROD) should not exceed 1 000 fpm and the ROD deviations should not exceed  $\pm 300$  fpm, except under exceptional circumstances which have been anticipated and briefed prior to commencing the approach; for example, a strong tailwind. Zero ROD may be used when the descent path needs to be regained from below the profile. The target ROD may need to be initiated prior to reaching the required descent point, typically 0.3 NM before the descent point, dependent upon ground speed, which may vary for each type/class of aeroplane.
  - (iii) The limits of thrust/power and the appropriate range should be specified in the OM Part B or equivalent document.
  - (iv) The optimum angle for the approach slope is  $3^\circ$  and should not exceed  $4.5^\circ$ .
  - (v) The CDFA technique should be applied only to approach procedures based on NDB, NDB/DME, VOR, VOR/DME, LOC, LOC/DME, VDF, SRA, GNSS/LNAV and fulfil the following criteria:
    - (A) the final approach track off-set  $\leq 5^\circ$  except for Category A and B aeroplanes, where the approach-track off-set is  $\leq 15^\circ$ ; and
    - (B) a FAF, or another appropriate fix, e.g. final approach point, where descent initiated is available; and
    - (C) the distance from the FAF or another appropriate fix to the threshold (THR) is less than or equal to 8 NM in the case of timing; or
    - (D) the distance to the THR is available by FMS/GNSS or DME; or
    - (E) the minimum final-segment of the designated constant angle approach path should not be less than 3 NM from the THR unless approved by the authority.
- (6) The CDFA techniques support a common method for the implementation of flight- director-guided or auto-coupled RNAV approaches.

## **AMC2 CAT.OP.MPA.115 Approach flight technique — aeroplanes**

### **NPA OPERATIONS WITHOUT APPLYING THE CDFA TECHNIQUE**

- (a) In case the CDFA technique is not used, the approach should be flown to an altitude/height at or above the MDA/H where a level flight segment at or above MDA/H may be flown to the MAPt.
- (b) Even when the approach procedure is flown without the CDFA technique, the relevant procedures for ensuring a controlled and stable path to MDA/H should be followed.

- (c) In case the CDFA technique is not used when flying an approach, the operator should implement procedures to ensure that early descent to the MDA/H will not result in a subsequent flight below MDA/H without adequate visual reference. These procedures could include:
  - (1) awareness of radio altimeter information with reference to the approach profile;
  - (2) terrain awareness warning system(TAWS);
  - (3) limitation of rate of descent;
  - (4) limitation of the number of repeated approaches;
  - (5) safeguards against too early descents with prolonged flight at MDA/H; and
  - (6) specification of visual requirements for the descent from the MDA/H.
- (d) In case the CDFA technique is not used and when the MDA/H is high, it may be appropriate to make an early descent to MDA/H with appropriate safeguards such as the application of a significantly higher RVR/VIS.
- (e) The procedures that are flown with level flight at/or above MDA/H should be listed in the OM.
- (f) Operators should categorise aerodromes where there are approaches that require level flight at/or above MDA/H as B and C. Such aerodrome categorisation will depend upon the operator's experience, operational exposure, training programme(s) and flight crew qualification(s).

### **AMC3 CAT.OP.MPA.115 Approach flight technique — aeroplanes**

#### OPERATIONAL PROCEDURES AND INSTRUCTIONS AND TRAINING

- (a) The operator should establish procedures and instructions for flying approaches using the CDFA technique and not using it. These procedures should be included in the OM and should include the duties of the flight crew during the conduct of such operations.
- (b) The operator should at least specify in the OM the maximum ROD for each aeroplane type/class operated and the required visual reference to continue the approach below:
  - (1) the DA/H, when applying the CDFA technique; and
  - (2) the MDA/H, when not applying the CDFA technique.
- (c) The operator should establish procedures which prohibit level flight at MDA/H without the flight crew having obtained the required visual references. It is not the intention to prohibit level flight at MDA/H when conducting a circling approach, which does not come within the definition of the CDFA technique.
- (d) The operator should provide the flight crew with unambiguous details of the technique used (CDFA or not). The corresponding relevant minima should include:
  - (1) type of decision, whether DA/H or MDA/H;
  - (2) MAPt as applicable; and
  - (3) appropriate RVR/VIS for the approach operation and aeroplane category.
- (e) Training

- (1) Prior to using the CDFA technique, each flight crew member should undertake appropriate training and checking as required by Subpart FC of Part ORO (ORO.FC). The operator's proficiency check should include at least one approach to a landing or missed approach as appropriate using the CDFA technique or not. The approach should be operated to the lowest appropriate DA/H or MDA/H, as appropriate; and, if conducted in a FSTD, the approach should be operated to the lowest approved RVR. The approach is not in addition to any manoeuvre currently required by either Part-FCL or Part- CAT. The provision may be fulfilled by undertaking any currently required approach, engine out or otherwise, other than a precision approach (PA), whilst using the CDFA technique.
- (2) The policy for the establishment of constant predetermined vertical path and approach stability is to be enforced both during initial and recurrent pilot training and checking. The relevant training procedures and instructions should be documented in the operations manual.
- (3) The training should emphasise the need to establish and facilitate joint crew procedures and crew resource management (CRM) to enable accurate descent path control and the provision to establish the aeroplane in a stable condition as required by the operator's operational procedures.
- (4) During training, emphasis should be placed on the flight crew's need to:
  - (i) maintain situational awareness at all times, in particular with reference to the required vertical and horizontal profile;
  - (ii) ensure good communication channels throughout the approach;
  - (iii) ensure accurate descent- path control particularly during any manually-flown descent phase. The monitoring pilot should facilitate good flight path control by:
    - (A) communicating any altitude/height crosschecks prior to the actual passing of the range/altitude or height crosscheck;
    - (B) prompting, as appropriate, changes to the target ROD; and
    - (C) monitoring flight path control below DA/MDA;
  - (iv) understand the actions to be taken if the MAPt is reached prior to the MDA/H;
  - (v) ensure that the decision for a missed approach is taken no later than when reaching the DA/H or MDA/H;
  - (vi) ensure that prompt action for a missed approach is taken immediately when reaching DA/H if the required visual reference has not been obtained as there may be no obstacle protection if the missed approach procedure manoeuvre is delayed;
  - (vii) understand the significance of using the CDFA technique to a DA/H with an associated MAPt and the implications of early missed approach manoeuvres; and
  - (viii) understand the possible loss of the required visual reference due to pitch-change/climb when not using the CDFA technique for aeroplane types or classes that require a late change of configuration and/or speed to ensure the aeroplane is in the appropriate landing configuration.
- (5) Additional specific training when not using the CDFA technique with level flight at or above MDA/H
  - (i) The training should detail:
    - (A) the need to facilitate CRM with appropriate flight crew communication in particular;

- (B) the additional known safety risks associated with the 'dive-and-drive' approach philosophy which may be associated with non-CDFA;
- (C) the use of DA/H during approaches flown using the CDFA technique;
- (D) the significance of the MDA/H and the MAPt where appropriate;
- (E) the actions to be taken at the MAPt and the need to ensure that the aeroplane remains in a stable condition and on the nominal and appropriate vertical profile until the landing;
- (F) the reasons for increased RVR/Visibility minima when compared to the application of CDFA;
- (G) the possible increased obstacle infringement risk when undertaking level flight at MDA/H without the required visual references;
- (H) the need to accomplish a prompt missed approach manoeuvre if the required visual reference is lost;
- (I) the increased risk of an unstable final approach and an associated unsafe landing if a rushed approach is attempted either from:
  - (a) inappropriate and close- in acquisition of the required visual reference; or
  - (b) unstable aeroplane energy and or flight path control; and
- (J) the increased risk of controlled flight into terrain (CFIT).

## **GM1 CAT.OP.MPA.115 Approach flight technique — aeroplanes**

### **CONTINUOUS DESCENT FINAL APPROACH (CDFA)**

#### **(a) Introduction**

- (1) Controlled flight into terrain (CFIT) is a major hazard in aviation. Most CFIT accidents occur in the final approach segment of non-precision approaches; the use of stabilised-approach criteria on a continuous descent with a constant, predetermined vertical path is seen as a major improvement in safety during the conduct of such approaches. Operators should ensure that the following techniques are adopted as widely as possible, for all approaches.
- (2) The elimination of level flight segments at MDA close to the ground during approaches, and the avoidance of major changes in attitude and power/thrust close to the runway that can destabilise approaches, are seen as ways to reduce operational risks significantly.
- (3) The term CDFA has been selected to cover a flight technique for any type of NPA operation.
- (4) The advantages of CDFA are as follows:
  - (i) the technique enhances safe approach operations by the utilisation of standard operating practices;
  - (ii) the technique is similar to that used when flying an ILS approach, including when executing the missed approach and the associated missed approach procedure manoeuvre;
  - (iii) the aeroplane attitude may enable better acquisition of visual cues;
  - (iv) the technique may reduce pilot workload;
  - (v) the approach profile is fuel- efficient;
  - (vi) the approach profile affords reduced noise levels;

- (vii) the technique affords procedural integration with APV operations; and
  - (viii) when used and the approach is flown in a stabilised manner, CDFA is the safest approach technique for all NPA operations.
- (b) CDFA
- (1) Continuous descent final approach is defined in appendix I to LCARs Air Operations.
  - (2) An approach is only suitable for application of a CDFA technique when it is flown along a nominal vertical profile: a nominal vertical profile is not forming part of the approach procedure design, but can be flown as a continuous descent. The nominal vertical profile information may be published or displayed on the approach chart to the pilot by depicting the nominal slope or range/distance vs height. Approaches with a nominal vertical profile are considered to be:
    - (i) NDB, NDB/DME;
    - (ii) VOR, VOR/DME;
    - (iii) LOC, LOC/DME;
    - (iv) VDF, SRA; or
    - (v) GNSS/LNAV.
  - (3) Stabilised approach (SAp) is defined in Appendix I to LCARs Air Operations.
    - (i) The control of the descent path is not the only consideration when using the CDFA technique. Control of the aeroplane's configuration and energy is also vital to the safe conduct of an approach.
    - (ii) The control of the flight path, described above as one of the specifications for conducting an SAp, should not be confused with the path specifications for using the CDFA technique. The predetermined path specification for conducting an SAp are established by the operator and published in the operations manual part B.
    - (iii) The predetermined approach slope specifications for applying the CDFA technique are established by the following:
      - (A) the published 'nominal' slope information when the approach has a nominal vertical profile; and
      - (B) the designated final-approach segment minimum of 3 NM, and maximum, when using timing techniques, of 8 NM.
    - (iv) An SAp will never have any level segment of flight at DA/H or MDA/H as applicable. This enhances safety by mandating a prompt missed approach procedure manoeuvre at DA/H or MDA/H.
    - (v) An approach using the CDFA technique will always be flown as an SAp, since this is a specification for applying CDFA. However, an SAp does not have to be flown using the CDFA technique, for example , a visual approach.

### **AMC1 CAT.OP.MPA.120 Airborne radar approaches (ARAs) for overwater operations — helicopters**

#### **GENERAL**

- (a) Before commencing the final approach the commander should ensure that a clear path exists on the radar screen for the final and missed approach segments. If lateral clearance from any obstacle is less than 1 NM, the commander should:
  - (1) approach to a nearby target structure and thereafter proceed visually to the destination structure; or
  - (2) make the approach from another direction leading to a circling manoeuvre.

- (b) The cloud ceiling should be sufficiently clear above the helideck to permit a safe landing.
- (c) MDH should not be less than 50 ft above the elevation of the helideck.
  - (1) The MDH for an airborne radar approach should not be lower than:
    - (i) 200 ft by day; or
    - (ii) 300 ft by night.
  - (2) The MDH for an approach leading to a circling manoeuvre should not be lower than:
    - (i) 300 ft by day; or
    - (ii) 500 ft by night.
- (d) MDA may only be used if the radio altimeter is unserviceable. The MDA should be a minimum of MDH +200 ft and should be based on a calibrated barometer at the destination or on the lowest forecast QNH for the region.
- (e) The decision range should not be less than  $\frac{3}{4}$  NM.
- (f) The MDA/H for a single-pilot ARA should be 100 ft higher than that calculated using (c) and (d) above. The decision range should not be less than 1 NM.

### **GM1 CAT.OP.MPA.120 Airborne radar approaches (ARAs) for overwater operations — helicopters**

#### GENERAL

- (a) General
  - (1) The helicopter ARA procedure may have as many as five separate segments. These are the arrival, initial, intermediate, final and missed approach segments. In addition, the specifications of the circling manoeuvre to a landing under visual conditions should be considered. The individual approach segments can begin and end at designated fixes. However, the segments of an ARA may often begin at specified points where no fixes are available.
  - (2) The fixes, or points, are named to coincide with the associated segment. For example, the intermediate segment begins at the intermediate fix (IF) and ends at the final approach fix (FAF). Where no fix is available or appropriate, the segments begin and end at specified points; for example, intermediate point (IP) and final approach point (FAP). The order in which this GM discusses the segments is the order in which the pilot would fly them in a complete procedure: that is, from the arrival through initial and intermediate to a final approach and, if necessary, the missed approach.
  - (3) Only those segments that are required by local conditions applying at the time of the approach need to be included in a procedure. In constructing the procedure, the final approach track, which should be orientated so as to be substantially into wind should be identified first as it is the least flexible and most critical of all the segments. When the origin and the orientation of the final approach have been determined, the other necessary segments should be integrated with it to produce an orderly manoeuvring pattern that does not generate an unacceptably high workload for the flight crew.
  - (4) Examples of ARA procedures, vertical profile and missed approach procedures are contained in Figures 1 to 5.
- (b) Obstacle environment

- (1) Each segment of the ARA is located in an overwater area that has a flat surface at sea level. However, due to the passage of large vessels which are not required to notify their presence, the exact obstacle environment cannot be determined. As the largest vessels and structures are known to reach elevations exceeding 500 ft above mean sea level (AMSL), the uncontrolled offshore obstacle environment applying to the arrival, initial and intermediate approach segments can reasonably be assumed to be capable of reaching to at least 500 ft AMSL. But, in the case of the final approach and missed approach segments, specific areas are involved within which no radar returns are allowed. In these areas, the height of wave crests and the possibility that small obstacles may be present that are not visible on radar results in an uncontrolled surface environment that extends to an elevation of 50 ft AMSL.
  - (2) Under normal circumstances, the relationship between the approach procedure and the obstacle environment is governed according to the concept that vertical separation is very easy to apply during the arrival, initial and intermediate segments, while horizontal separation, which is much more difficult to guarantee in an uncontrolled environment, is applied only in the final and missed approach segments.
- (c) Arrival segment
- The arrival segment commences at the last en-route navigation fix, where the aircraft leaves the helicopter route, and it ends either at the initial approach fix (IAF) or, if no course reversal, or similar manoeuvre is required, it ends at the IF. Standard en-route obstacle clearance criteria should be applied to the arrival segment.
- (d) Initial approach segment
- The initial approach segment is only required if a course reversal, race track, or arc procedure is necessary to join the intermediate approach track. The segment commences at the IAF and on completion of the manoeuvre ends at the IP. The minimum obstacle clearance (MOC) assigned to the initial approach segment is 1000 ft.
- (e) Intermediate approach segment
- The intermediate approach segment commences at the IP, or in the case of straight-in approaches, where there is no initial approach segment, it commences at the IF. The segment ends at the FAP and should not be less than 2 NM in length. The purpose of the intermediate segment is to align and prepare the helicopter for the final approach. During the intermediate segment, the helicopter should be lined up with the final approach track, the speed should be stabilised, the destination should be identified on the radar, and the final approach and missed approach areas should be identified and verified to be clear of radar returns. The MOC assigned to the intermediate segment is 500 ft.
- (f) Final approach segment
- (1) The final approach segment commences at the FAP and ends at the missed approach point (MAPt). The final approach area, which should be identified on radar, takes the form of a corridor between the FAP and the radar return of the destination. This corridor should not be less than 2 NM wide in order that the projected track of the helicopter does not pass closer than 1 NM to the obstacles lying outside the area.

- (2) On passing the FAP, the helicopter will descend below the intermediate approach altitude, and follow a descent gradient which should not be steeper than 6.5 %. At this stage, vertical separation from the offshore obstacle environment will be lost. However, within the final approach area the MDA/H will provide separation from the surface environment. Descent from 1 000 ft AMSL to 200 ft AMSL at a constant 6.5 % gradient will involve a horizontal distance of 2 NM. In order to follow the guideline that the procedure should not generate an unacceptably high workload for the flight crew, the required actions of levelling at MDH, changing heading at the offset initiation point (OIP), and turning away at MAPt should not be planned to occur at the same NM time from the destination.
  - (3) During the final approach, compensation for drift should be applied and the heading which, if maintained, would take the helicopter directly to the destination, should be identified. It follows that, at an OIP located at a range of 1.5 NM, a heading change of 10° is likely to result in a track offset of 15° at 1 NM, and the extended centreline of the new track can be expected to have a mean position lying some 300 - 400 m to one side of the destination structure. The safety margin built in to the 0.75 NM decision range (DR) is dependent upon the rate of closure with the destination. Although the airspeed should be in the range 60- 90 kt during the final approach, the ground speed, after due allowance for wind velocity, should be no greater than 70 kt.
- (g) Missed approach segment
- (1) The missed approach segment commences at the MAPt and ends when the helicopter reaches minimum en- route altitude. The missed approach manoeuvre is a 'turning missed approach' which should be of not less than 30° and should not, normally, be greater than 45°. A turn away of more than 45° does not reduce the collision risk factor any further, nor will it permit a closer DR. However, turns of more than 45° may increase the risk of pilot disorientation and, by inhibiting the rate of climb (especially in the case of an OEI missed approach procedure), may keep the helicopter at an extremely low level for longer than is desirable.
  - (2) The missed approach area to be used should be identified and verified as a clear area on the radar screen during the intermediate approach segment. The base of the missed approach area is a sloping surface at 2.5 % gradient starting from MDH at the MAPt. The concept is that a helicopter executing a turning missed approach will be protected by the horizontal boundaries of the missed approach area until vertical separation of more than 130 ft is achieved between the base of the area and the offshore obstacle environment of 500 ft AMSL which prevails outside the area.
  - (3) A missed approach area, taking the form of a 45° sector orientated left or right of the final approach track, originating from a point 5 NM short of the destination, and terminating on an arc 3 NM beyond the destination, will normally satisfy the specifications of a 30° turning missed approach.
- (h) The required visual reference
- The visual reference required is that the destination should be in view in order that a safe landing may be carried out.
- (i) Radar equipment
- During the ARA procedure, colour mapping radar equipment with a 120° sector scan and 2.5 NM range scale selected, may result in dynamic errors of the following order:
- (1) bearing/tracking error  $\pm 4.5^\circ$  with 95 % accuracy;
  - (2) mean ranging error -250 m; or



- (3) random ranging error  $\pm 250$  m with 95 % accuracy.

Figure 1: Arc procedure

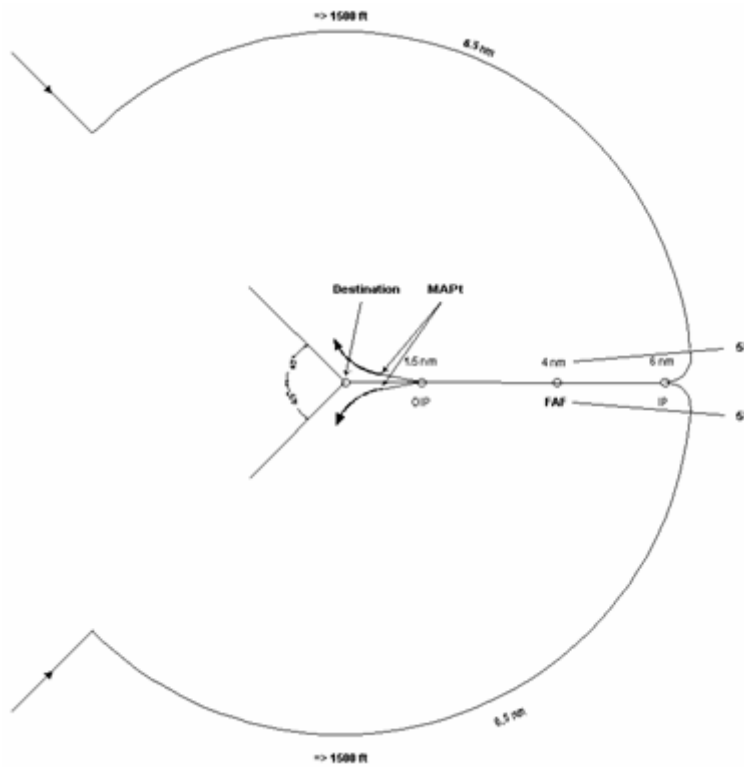


Figure 2: Base turn procedure — direct approach

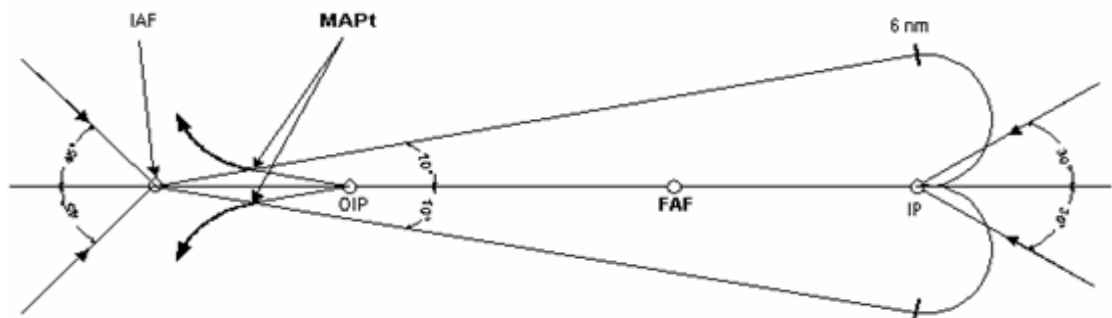


Figure 3: Holding pattern & race track procedure

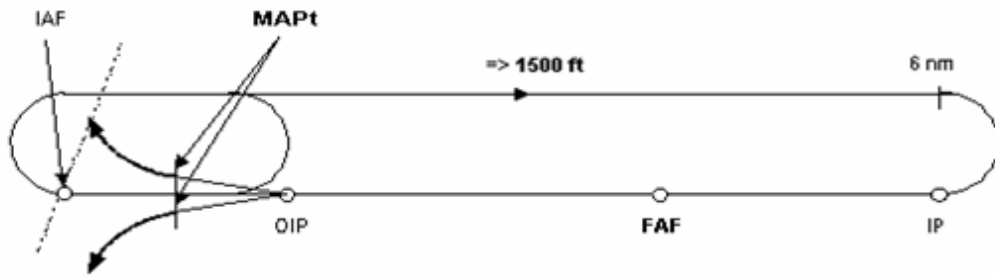


Figure 4: Vertical profile

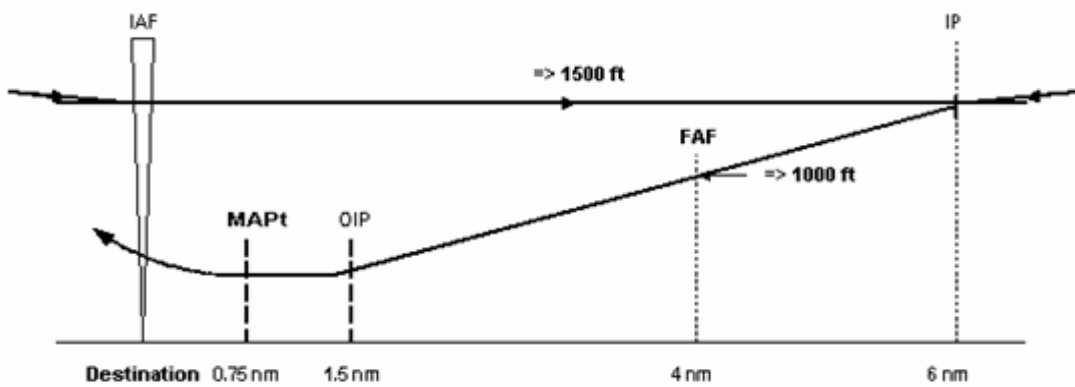
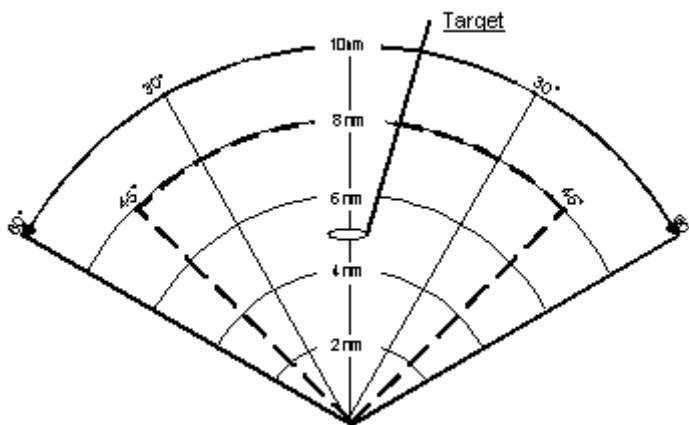


Figure 5: Missed approach area left & right



**AMC1 CAT.OP.MPA.126 Performance-based navigation**

## PBN OPERATIONS

- (a) For operations where a navigation specification for performance-based navigation (PBN) has been prescribed and no specific approval is required in accordance with SPA.PBN.100, the operator should:
- (b) establish operating procedures specifying:
  - (1) normal, abnormal and contingency procedures;
  - (2) electronic navigation database management; and
  - (3) relevant entries in the minimum equipment list (MEL);
- (c) specify the flight crew qualification and proficiency constraints and ensure that the training programme for relevant personnel is consistent with the intended operation; and
- (d) ensure continued airworthiness of the area navigation system.

**AMC2 CAT.OP.MPA.126 Performance-based navigation**

## MONITORING AND VERIFICATION

- (a) Preflight and general considerations
  - (1) At navigation system initialisation, the flight crew should confirm that the navigation database is current and verify that the aircraft position has been entered correctly, if required.
  - (2) The active flight plan, if applicable, should be checked by comparing the charts or other applicable documents with navigation equipment and displays. This includes confirmation of the departing runway and the waypoint sequence, reasonableness of track angles and distances, any altitude or speed constraints, and, where possible, which waypoints are fly-by and which are fly-over. Where relevant, the RF leg arc radii should be confirmed.
  - (3) The flight crew should check that the navigation aids critical to the operation of the intended PBN procedure are available.
  - (4) The flight crew should confirm the navigation aids that should be excluded from the operation, if any.
  - (5) An arrival, approach or departure procedure should not be used if the validity of the procedure in the navigation database has expired.
  - (6) The flight crew should verify that the navigation systems required for the intended operation are operational.
- (b) Departure
  - (1) Prior to commencing a take-off on a PBN procedure, the flight crew should check that the indicated aircraft position is consistent with the actual aircraft position at the start of the take-off roll (aeroplanes) or lift-off (helicopters).
  - (2) Where GNSS is used, the signal should be acquired before the take-off roll (aeroplanes) or lift-off (helicopters) commences.
  - (3) Unless automatic updating of the actual departure point is provided, the flight crew should ensure initialisation on the runway or FATO by means of a manual runway threshold or intersection update, as applicable. This is to preclude any inappropriate or inadvertent position shift after take-off.
- (c) Arrival and approach

- (1) The flight crew should verify that the navigation system is operating correctly and the correct arrival procedure and runway (including any applicable transition) are entered and properly depicted.
  - (2) Any published altitude and speed constraints should be observed.
  - (3) The flight crew should check approach procedures (including alternate aerodromes if needed) as extracted by the system (e.g. CDU flight plan page) or presented graphically on the moving map, in order to confirm the correct loading and the reasonableness of the procedure content.
  - (4) Prior to commencing the approach operation (before the IAF), the flight crew should verify the correctness of the loaded procedure by comparison with the appropriate approach charts. This check should include:
    - (i) the waypoint sequence;
    - (ii) reasonableness of the tracks and distances of the approach legs and the accuracy of the inbound course; and
    - (iii) the vertical path angle, if applicable.
- (d) Altimetry settings for RNP APCH operations using Baro VNAV
- Barometric settings
- (1) The flight crew should set and confirm the correct altimeter setting and check that the two altimeters provide altitude values that do not differ more than 100 ft at the most at or before the final approach fix (FAF).
    - (i) The flight crew should fly the procedure with:
      - (A) a current local altimeter setting source available — a remote or regional altimeter setting source should not be used; and
      - (B) the QNH/QFE, as appropriate, set on the aircraft's altimeters.

Temperature compensation

    - (ii) For RNP APCH operations to LNAV/VNAV minima using Baro VNAV:
      - (A) the flight crew should not commence the approach when the aerodrome temperature is outside the promulgated aerodrome temperature limits for the procedure unless the area navigation system is equipped with approved temperature compensation for the final approach;
      - (B) when the temperature is within promulgated limits, the flight crew should not make compensation to the altitude at the FAF and DA/H;
      - (C) since only the final approach segment is protected by the promulgated aerodrome temperature limits, the flight crew should consider the effect of temperature on terrain and obstacle clearance in other phases of flight.
    - (iii) For RNP APCH operations to LNAV minima, the flight crew should consider the effect of temperature on terrain and obstacle clearance in all phases of flight, in particular on any step-down fix.
- (e) Sensor and lateral navigation accuracy selection
- For multi-sensor systems, the flight crew should verify, prior to approach, that the GNSS sensor is used for position computation.
- Flight crew of aircraft with RNP input selection capability should confirm that the indicated RNP value is appropriate for the PBN operation.

### **AMC3 CAT.OP.MPA.126 Performance-based navigation**

#### MANAGEMENT OF THE NAVIGATION DATABASE

- (a) For RNAV 1, RNAV 2, RNP 1, RNP 2, and RNP APCH, the flight crew should neither insert nor modify waypoints by manual entry into a procedure (departure, arrival or approach) that has been retrieved from the database. User-defined data may be entered and used for waypoint altitude/speed constraints on a procedure where said constraints are not included in the navigation database coding.
- (b) For RNP 4 operations, the flight crew should not modify waypoints that have been retrieved from the database. User-defined data (e.g. for flex-track routes) may be entered and used.
- (c) The lateral and vertical definition of the flight path between the FAF and the missed approach point (MAPt) retrieved from the database should not be revised by the flight crew.

#### **AMC4 CAT.OP.MPA.126 Performance-based navigation**

##### DISPLAYS AND AUTOMATION

- (a) For RNAV 1, RNP 1, and RNP APCH operations, the flight crew should use a lateral deviation indicator, and where available, flight director and/or autopilot in lateral navigation mode.
- (b) The appropriate displays should be selected so that the following information can be monitored:
  - (1) the computed desired path;
  - (2) aircraft position relative to the lateral path (cross-track deviation) for FTE monitoring; (3
  - (3) aircraft position relative to the vertical path (for a 3D operation).
- (c) The flight crew of an aircraft with a lateral deviation indicator (e.g. CDI) should ensure that lateral deviation indicator scaling (full-scale deflection) is suitable for the navigation accuracy associated with the various segments of the procedure.
- (d) The flight crew should maintain procedure centrelines unless authorised to deviate by air traffic control (ATC) or demanded by emergency conditions.
- (e) Cross-track error/deviation (the difference between the area-navigation-system-computed path and the aircraft-computed position) should normally be limited to  $\pm \frac{1}{2}$  time the RNAV/RNP value associated with the procedure. Brief deviations from this standard (e.g. overshoots or undershoots during and immediately after turns) up to a maximum of 1 time the RNAV/RNP value should be allowable.
- (f) For a 3D approach operation, the flight crew should use a vertical deviation indicator and, where required by AFM limitations, a flight director or autopilot in vertical navigation mode.
- (g) Deviations below the vertical path should not exceed 75 ft at any time, or half-scale deflection where angular deviation is indicated, and not more than 75 ft above the vertical profile, or half-scale deflection where angular deviation is indicated, at or below 1 000 ft above aerodrome level. The flight crew should execute a missed approach if the vertical deviation exceeds this criterion, unless the flight crew has in sight the visual references required to continue the approach.

#### **AMC5 CAT.OP.MPA.126 Performance-based navigation**

##### VECTORING AND POSITIONING

- (a) ATC tactical interventions in the terminal area may include radar headings, 'direct to' clearances which bypass the initial legs of an approach procedure, interceptions of an initial or intermediate segments of an approach procedure or the insertion of additional waypoints loaded from the database.
- (b) In complying with ATC instructions, the flight crew should be aware of the implications for the navigation system.

- (c) 'Direct to' clearances may be accepted to the IF provided that it is clear to the flight crew that the aircraft will be established on the final approach track at least 2 NM before the FAF.
- (d) 'Direct to' clearance to the FAF should not be acceptable. Modifying the procedure to intercept the final approach track prior to the FAF should be acceptable for radar-vectored arrivals or otherwise only with ATC approval.
- (e) The final approach trajectory should be intercepted no later than the FAF in order for the aircraft to be correctly established on the final approach track before starting the descent (to ensure terrain and obstacle clearance).
- (f) 'Direct to' clearances to a fix that immediately precede an RF leg should not be permitted.
- (g) For parallel offset operations en route in RNP 4 and A-RNP, transitions to and from the offset track should maintain an intercept angle of no more than 45° unless specified otherwise by ATC.

### **AMC6 CAT.OP.MPA.126 Performance-based navigation**

#### ALERTING AND ABORT

- (a) Unless the flight crew has sufficient visual reference to continue the approach operation to a safe landing, an RNP APCH operation should be discontinued if:
  - (1) navigation system failure is annunciated (e.g. warning flag);
  - (2) lateral or vertical deviations exceed the tolerances;
  - (3) loss of the on-board monitoring and alerting system.
- (b) Discontinuing the approach operation may not be necessary for a multi-sensor navigation system that includes demonstrated RNP capability without GNSS in accordance with the AFM.
- (c) Where vertical guidance is lost while the aircraft is still above 1 000 ft AGL, the flight crew may decide to continue the approach to LNAV minima, when supported by the navigation system

### **AMC7 CAT.OP.MPA.126 Performance-based navigation**

#### CONTINGENCY PROCEDURES

- (a) The flight crew should make the necessary preparation to revert to a conventional arrival procedure where appropriate. The following conditions should be considered:
  - (1) failure of the navigation system components including navigation sensors, and a failure effecting flight technical error (e.g. failures of the flight director or autopilot);
  - (2) multiple system failures affecting aircraft performance;
  - (3) coasting on inertial sensors beyond a specified time limit; and
  - (4) RAIM (or equivalent) alert or loss of integrity function.
- (b) In the event of loss of PBN capability, the flight crew should invoke contingency procedures and navigate using an alternative means of navigation.
- (c) The flight crew should notify ATC of any problem with PBN capability.
- (d) In the event of communication failure, the flight crew should continue with the operation in accordance with published lost communication procedures.

### **GM1 CAT.OP.MPA.126 Performance-based navigation**

#### DESCRIPTION

- (a) For both, RNP X and RNAV X designations, the 'X' (where state d) refers to the lateral navigation accuracy (total system error) in NM, which is expected to be achieved at least 95 % of the flight time by the population of aircraft operating within the airspace, route or procedure. For RNP APCH and A-RNP, the lateral navigation accuracy depends on the segment.
- (b) PBN may be required on notified routes, for notified procedures and in notified airspace.

#### RNAV 10

- (c) For purposes of consistency with the PBN concept, this Regulation is using the designation 'RNAV 10' because this specification does not include on-board performance monitoring and alerting.
- (d) However, it should be noted that many routes still use the designation 'RNP 10' instead of 'RNAV 10'.

'RNP 10' was used as designation before the publication of the fourth edition of ICAO Doc 9613 in 2013. The terms 'RNP 10' and 'RNAV 10' should be considered equivalent.

### **AMC1 CAT.OP.MPA.130 Noise abatement procedures — aeroplanes**

#### NADP DESIGN

- (a) For each aeroplane type, two departure procedures should be defined, in accordance with ICAO Doc 8168 (Procedures for Air Navigation Services, 'PANS-OPS'), Volume I: I:
  - (1) noise abatement departure procedure one (NADP 1), designed to meet the close-in noise abatement objective; and
  - (2) noise abatement departure procedure two (NADP 2), designed to meet the distant noise abatement objective.
- (b) For each type of NADP (1 and 2), a single climb profile should be specified for use at all aerodromes, which is associated with a single sequence of actions. The NADP 1 and NADP 2 profiles may be identical.

### **GM1 CAT.OP.MPA.130 Noise abatement procedures — aeroplanes**

#### TERMINOLOGY

- (a) 'Climb profile' means in this context the vertical path of the NADP as it results from the pilot's actions (engine power reduction, acceleration, slats/flaps retraction).
- (b) 'Sequence of actions' means the order in which these pilot's actions are done and their timing.

#### GENERAL

- (c) The rule addresses only the vertical profile of the departure procedure. Lateral track has to comply with the standard instrument departure (SID).

#### EXAMPLE

- (d) For a given aeroplane type, when establishing the distant NADP, the operator should choose either to reduce power first and then accelerate, or to accelerate first and then wait until slats/flaps are retracted before reducing power. The two methods constitute two different sequences of actions.
- (e) For an aeroplane type, each of the two departure climb profiles may be defined by one sequence of actions (one for close-in, one for distant) and two above aerodrome level (AAL) altitudes/heights. These are:
  - (1) the altitude of the first pilot's action (generally power reduction with or without acceleration). This altitude should not be less than 800 ft AAL; or
  - (2) the altitude of the end of the noise abatement procedure. This altitude should usually not be more than 3 000 ft AAL.



These two altitudes may be runway specific when the aeroplane flight management system (FMS) has the relevant function which permits the crew to change thrust reduction and/or acceleration altitude/height. If the aeroplane is not FMS-equipped or the FMS is not fitted with the relevant function, two fixed heights should be defined and used for each of the two NADPs.

### **AMC1 CAT.OP.MPA.135 Routes and areas of operation — general**

#### RNAV 10

- (a) Operating procedures and routes should take account of the RNAV 10 time limit declared for the inertial system, if applicable, considering also the effect of weather conditions that could affect flight duration in RNAV 10 airspace.
- (b) The operator may extend RNAV 10 inertial navigation time by position updating. The operator should calculate, using statistically-based typical wind scenarios for each planned route, points at which updates can be made, and the points at which further updates will not be possible.

### **GM1 CAT.OP.MPA.137(b) Routes and areas of operation — helicopters**

#### COASTAL TRANSIT

- (a) General
  - (1) Helicopters operating overwater in performance class 3 have to have certain equipment fitted. This equipment varies with the distance from land that the helicopter is expected to operate. The aim of this GM is to discuss that distance, bring into focus what fit is required and to clarify the operator's responsibility, when a decision is made to conduct coastal transit operations.
  - (2) In the case of operations north of 45N or south of 45S, the coastal corridor facility may or may not be available in a particular state, as it is related to the State definition of open sea area as described in the definition of hostile environment.
  - (3) Where the term 'coastal transit' is used, it means the conduct of operations overwater within the coastal corridor in conditions where there is reasonable expectation that:
    - (i) the flight can be conducted safely in the conditions prevailing;
    - (ii) following an engine failure, a safe forced landing and successful evacuation can be achieved; and
    - (iii) survival of the crew and passengers can be assured until rescue is effected.
  - (4) Coastal corridor is a variable distance from the coastline to a maximum distance corresponding to three minutes' flying at normal cruising speed.
- (b) Establishing the width of the coastal corridor
  - (1) The maximum distance from land of coastal transit, is defined as the boundary of a corridor that extends from the land, to a maximum distance of up to 3 minutes at normal cruising speed (approximately 5 - 6 NM). Land in this context includes sustainable ice (see (i) to (iii) below) and, where the coastal region includes islands, the surrounding waters may be included in the corridor and aggregated with the coast and each other. Coastal transit need not be applied to inland waterways, estuary crossing or river transit.
    - (i) In some areas, the formation of ice is such that it can be possible to land, or force land, without hazard to the helicopter or occupants. Unless the LyCAA considers that operating to, or over, such ice fields is unacceptable, the operator may regard that the definition of the 'land' extends to these areas.

- (ii) The interpretation of the following rules may be conditional on (i) above:
  - CAT.OP.MPA.137(a)(2);
  - CAT.IDE.H.290;
  - CAT.IDE.H.295;
  - CAT.IDE.H.300; and
  - CAT.IDE.H.320.
- (iii) In view of the fact that such featureless and flat white surfaces could present a hazard and could lead to white-out conditions, the definition of land does not extend to flights over ice fields in the following rules:
  - CAT.IDE.H.125(d); and
  - CAT.IDE.H.145.
- (2) The width of the corridor is variable from not safe to conduct operations in the conditions prevailing, to the maximum of 3 minutes wide. A number of factors will, on the day, indicate if it can be used — and how wide it can be. These factors will include, but not be restricted to, the following:
  - (i) meteorological conditions prevailing in the corridor;
  - (ii) instrument fit of the aircraft;
  - (iii) certification of the aircraft — particularly with regard to floats;
  - (iv) sea state;
  - (v) temperature of the water;
  - (vi) time to rescue; and
  - (vii) survival equipment carried.
- (3) These can be broadly divided into three functional groups:
  - (i) those that meet the provisions for safe flying;
  - (ii) those that meet the provisions for a safe forced landing and evacuation; and
  - (iii) those that meet the provisions for survival following a forced landing and successful evacuation.
- (c) Provision for safe flying
  - (1) It is generally recognised that when flying out of sight of land in certain meteorological conditions, such as those occurring in high pressure weather patterns (goldfish bowl — no horizon, light winds and low visibility), the absence of a basic panel (and training) can lead to disorientation. In addition, lack of depth perception in these conditions demands the use of a radio altimeter with an audio voice warning as an added safety benefit — particularly when autorotation to the surface of the water may be required.
  - (2) In these conditions, the helicopter, without the required instruments and radio altimeter, should be confined to a corridor in which the pilot can maintain reference using the visual cues on the land.
- (d) Provision for a safe forced landing and evacuation
  - (1) Weather and sea state both affect the outcome of an autorotation following an engine failure. It is recognised that the measurement of sea state is problematical and when assessing such conditions, good judgement has to be exercised by the operator and the commander.
  - (2) Where floats have been certificated only for emergency use (and not for ditching), operations should be limited to those sea states that meet the provisions for such use — where a safe evacuation is possible.

Ditching certification requires compliance with a comprehensive number of requirements relating to rotorcraft water entry, flotation and trim, occupant egress and occupant survival. Emergency flotation systems, generally fitted to smaller CS- 27 rotorcraft, are approved against a broad specification that the equipment should perform its intended function and not hazard the rotorcraft or its occupants. In practice, the most significant difference between ditching and emergency flotation systems is substantiation of the water entry phase. Ditching rules call for water entry procedures and techniques to be established and promulgated in the AFM. The fuselage/flotation equipment should thereafter be shown to be able to withstand loads under defined water entry conditions which relate to these procedures. For emergency flotation equipment, there is no specification to define the water entry technique and no specific conditions defined for the structural substantiation.

(e) Provisions for survival

- (1) Survival of crew members and passengers, following a successful autorotation and evacuation, is dependent on the clothing worn, the equipment carried and worn, the temperature of the sea and the sea state. Search and rescue (SAR) response/capability consistent with the anticipated exposure should be available before the conditions in the corridor can be considered non-hostile.
- (2) Coastal transit can be conducted (including north of 45N and south of 45S — when the definition of open sea areas allows) providing the provisions of (c) and (d) are met, and the conditions for a non-hostile coastal corridor are satisfied.

**AMC1 CAT.OP.MPA.140(c) Maximum distance from an adequate aerodrome for two-engined aeroplanes without an ETOPS approval**

OPERATION OF NON-ETOPS COMPLIANT TWIN TURBO-JET AEROPLANES WITH MOPSC OF 19 OR LESS AND MCTOM LESS THAN 45 360 KG BETWEEN 120 AND 180 MINUTES FROM AN ADEQUATE AERODROME

- (a) For operations between 120 and 180 minutes, due account should be taken of the aeroplane's design and capabilities as outlined below and the operator's experience related to such operations. Relevant information should be included in the operations manual and the operator's maintenance procedures. The term 'the aeroplane's design' in this AMC does not imply any additional type design approval specifications beyond the applicable original type certificate (TC) specifications.
- (b) Systems capability
- Aeroplanes should be certified to CS-25 as appropriate or equivalent (e.g. FAR-25). With respect to the capability of the aeroplane systems, the objective is that the aeroplane is capable of a safe diversion from the maximum diversion distance with particular emphasis on operations with OEI or with degraded system capability. To this end, the operator should give consideration to the capability of the following systems to support such a diversion:
- (1) Propulsion systems: the aeroplane engine should meet the applicable specifications prescribed in CS-25 and CS-E or equivalent (e.g. FAR- 25, FAR- E), concerning engine TC, installation and system operation. In addition to the performance standards at the time of engine certification, the engines should comply with all subsequent mandatory safety standards specified, including those necessary to maintain an acceptable level of reliability. In addition, consideration should be given to the effects of extended duration single-engine operation (e.g. the effects of higher power demands such as bleed and electrical).
  - (2) Airframe systems: with respect to electrical power, three or more reliable as defined by CS-25 or equivalent (e.g. FAR- 25) and independent electrical power sources should be available, each of which should be capable of providing power for all essential services which should at least include the following:
    - (i) sufficient instruments for the flight crew providing, as a minimum, attitude, heading, airspeed and altitude information;
    - (ii) appropriate pitot heating;
    - (iii) adequate navigation capability;
    - (iv) adequate radio communication and intercommunication capability;
    - (v) adequate flight deck and instrument lighting and emergency lighting;
    - (vi) adequate flight controls;
    - (vii) adequate engine controls and restart capability with critical type fuel (from the stand-point of flame-out and restart capability) and with the aeroplane initially at the maximum relight altitude;
    - (viii) adequate engine instrumentation;
    - (ix) adequate fuel supply system capability including such fuel boost and fuel transfer functions that may be necessary for extended duration single or dual- engine operation;
    - (x) such warnings, cautions and indications as are required for continued safe flight and landing;
    - (xi) fire protection (engines and auxiliary power unit (APU));
    - (xii) adequate ice protection including windshield de-icing; and

- (xiii) adequate control of the flight crew compartment and cabin environment including heating and pressurisation.

The equipment including avionics necessary for extended diversion times should have the ability to operate acceptably following failures in the cooling system or electrical power systems.

For single-engine operations, the remaining power electrical, hydraulic, and pneumatic should continue to be available at levels necessary to permit continued safe flight and landing, and to provide those services necessary for the overall safety of the passengers and crew. As a minimum, following the failure of any two of the three electrical power sources, the remaining source should be capable of providing power for all of the items necessary for the duration of any diversion. If one or more of the required electrical power sources are provided by an APU, hydraulic system or air driven generator/ram air turbine (ADG/RAT), the following criteria should apply as appropriate:

- (i) to ensure hydraulic power (hydraulic motor generator) reliability, it may be necessary to provide two or more independent energy sources;
  - (ii) the ADG/RAT, if fitted, should not require engine dependent power for deployment; and
  - (iii) the APU should meet the criteria in (b)(3).
- (3) APU: the APU, if required for extended range operations, should be certified as an essential APU and should meet the applicable CS- 25 and CS-APU provisions or equivalent (e.g. FAR-25).
  - (4) Fuel supply system: consideration should include the capability of the fuel supply system to provide sufficient fuel for the entire diversion taking account of aspects such as fuel boost and fuel transfer.
- (c) Engine events and corrective action
    - (1) All engine events and operating hours should be reported by the operator to the airframe and engine supplemental type certificate (STC) holders as well as to the LyCAA.
    - (2) These events should be evaluated by the operator in consultation with the LyCAA and with the engine and airframe (S)TC holders.
    - (3) Where statistical assessment alone is not applicable, e.g. where the fleet size or accumulated flight hours are small, individual engine events should be reviewed on a case-by-case basis.
    - (4) The evaluation or statistical assessment, when available, may result in corrective action or the application of operational restrictions.
    - (5) Engine events could include engine shutdowns, both on ground and in-flight, excluding normal training events, including flameout, occurrences where the intended thrust level was not achieved or where crew action was taken to reduce thrust below the normal level for whatever reason, and unscheduled removals.
    - (6) Arrangements to ensure that all corrective actions required are implemented.
  - (d) Maintenance
 

The maintenance programme in accordance with LCAR Part-M should be based upon reliability programmes including, but not limited to, the following elements:

    - (1) engine oil consumption programmes: such programmes are intended to support engine condition trend monitoring; and
    - (2) engine condition monitoring programme: a programme for each engine that monitors engine performance parameters and trends of degradation that provides for maintenance actions to be undertaken prior to significant performance loss or mechanical failure.

(e) Flight crew training

Flight crew training for this type of operation should include, in addition to the requirements of Subpart FC of Part ORO (ORO.FC), particular emphasis on the following:

- (1) Fuel management: verifying required fuel on board prior to departure and monitoring fuel on board en-route including calculation of fuel remaining. Procedures should provide for an independent check of fuel quantity indicators, e.g. fuel flow used to calculate fuel burned compared to indicate fuel remaining. Confirmation that the fuel remaining is sufficient to satisfy the critical fuel reserves.
- (2) Procedures for single and multiple failures in-flight that may give rise to go/no-go and diversion decisions — policy and guidelines to aid the flight crew in the diversion decision making process and the need for constant awareness of the closest weather-permissible alternate aerodrome in terms of time.
- (3) OEI performance data: drift down procedures and OEI service ceiling data.
- (4) Weather reports and flight requirements: meteorological aerodrome reports (METARs) and aerodrome forecast (TAF) reports and obtaining in-flight weather updates on the en-route alternate (ERA), destination and destination alternate aerodromes. Consideration should also be given to forecast winds including the accuracy of the forecast compared to actual wind experienced during flight and meteorological conditions along the expected flight path at the OEI cruising altitude and throughout the approach and landing.

(f) Pre-departure check

A pre-departure check, additional to the pre-flight inspection required by Part-M should be reflected in the operations manual. Flight crew members who are responsible for the pre-departure check of an aeroplane should be fully trained and competent to do it. The training programme required should cover all relevant tasks with particular emphasis on checking required fluid levels.

(g) MEL

The MEL should take into account all items specified by the manufacturer relevant to operations in accordance with this AMC.

(h) Dispatch/flight planning rules

The operator's dispatch rules should address the following:

- (1) Fuel and oil supply: an aeroplane should not be dispatched on an extended range flight unless it carries sufficient fuel and oil to comply with the applicable operational requirements and any additional reserves determined in accordance with the following:
  - (i) Critical fuel scenario — the critical point is the furthest point from an alternate aerodrome assuming a simultaneous failure of an engine and the pressurisation system. For those aeroplanes that are type certificated to operate above flight level 450, the critical point is the furthest point from an alternate aerodrome assuming an engine failure. The operator should carry additional fuel for the worst case fuel burn condition (one engine vs two engines operating) if this is greater than the additional fuel calculated in accordance with the fuel requirements in CAT.OP.MPA, as follows:
    - (A) fly from the critical point to an alternate aerodrome:
      - (a) at 10 000 ft;

- (b) at 25 000 ft or the single-engine ceiling, whichever is lower, provided that all occupants can be supplied with and use oxygen for the time required to fly from the critical point to an alternate aerodrome; or
  - (c) at the single-engine ceiling, provided that the aeroplane is type certified to operate above flight level 450;
- (B) descend and hold at 1 500 ft for 15 minutes in international standard atmosphere (ISA) conditions;
  - (C) descend to the applicable MDA/DH followed by a missed approach (taking into account the complete missed approach procedure); followed by
  - (D) a normal approach and landing.
- (ii) Ice protection: additional fuel used when operating in icing conditions (e.g. operation of ice protection systems (engine/airframe as applicable)) and, when manufacturer's data are available, take account of ice accumulation on unprotected surfaces if icing conditions are likely to be encountered during a diversion.
  - (iii) APU operation: if an APU has to be used to provide additional electrical power, consideration should be given to the additional fuel required.
- (2) Communication facilities: the availability of communications facilities in order to allow reliable two-way voice communications between the aeroplane and the appropriate ATC unit at OEI cruise altitudes.
  - (3) Aircraft technical log review to ensure proper MEL procedures, deferred items, and required maintenance checks completed.
  - (4) ERA aerodrome(s): ensuring that ERA aerodromes are available for the intended route, within the distance flown in 180 minutes based upon the OEI cruising speed which is a speed within the certificated limits of the aeroplane, selected by the operator and approved by the LyCAA, confirming that, based on the available meteorological information, the weather conditions at ERA aerodromes are at or above the applicable minima for the period of time during which the aerodrome(s) may be used.

**Table 1:** Planning minima

Approach facility	Alternate aerodrome ceiling	Weather minima RVR/VIS
PA	DA/H +200 ft	RVR/VIS +800 m
NPA Circling approach	MDA/H+400 ft	RVR/VIS +1 500 m

### **GM1 CAT.OP.MPA.140(c) Maximum distance from an adequate aerodrome for two-engined aeroplanes without an ETOPS approval**

#### **ONE-ENGINE-INOPERATIVE (OEI) CRUISING SPEED**

The OEI cruising speed is intended to be used solely for establishing the maximum distance from an adequate aerodrome.

### **AMC1 CAT.OP.MPA.145(a) Establishment of minimum flight altitudes**

#### **CONSIDERATIONS FOR ESTABLISHING MINIMUM FLIGHT ALTITUDES**

- (a) The operator should take into account the following factors when establishing minimum flight altitudes:
  - (1) the accuracy with which the position of the aircraft can be determined;

- (2) the probable inaccuracies in the indications of the altimeters used;
  - (3) the characteristics of the terrain, such as sudden changes in the elevation, along the routes or in the areas where operations are to be conducted;
  - (4) the probability of encountering unfavourable meteorological conditions, such as severe turbulence and descending air currents; and
  - (5) possible inaccuracies in aeronautical charts.
- (b) The operator should also consider:
- (1) corrections for temperature and pressure variations from standard values;
  - (2) ATC requirements; and
  - (3) any foreseeable contingencies along the planned route.

### **AMC1.1 CAT.OP.MPA.145(a) Establishment of minimum flight altitudes**

#### CONSIDERATIONS FOR ESTABLISHING MINIMUM FLIGHT ALTITUDES

This AMC provides another means of complying with the rule for VFR operations of other-than-complex motor-powered aircraft by day, compared to that presented in AMC1 CAT.OP.MPA.145(a). The safety objective should be satisfied if the operator ensures that operations are only conducted along such routes or within such areas for which a safe terrain clearance can be maintained and take account of such factors as temperature, terrain and unfavourable meteorological conditions.

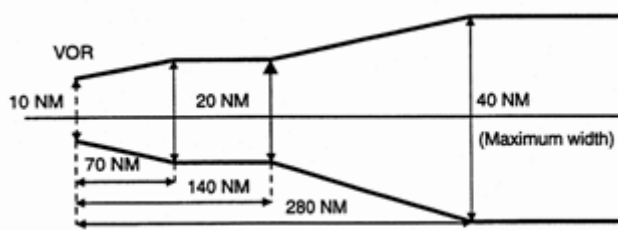
### **GM1 CAT.OP.MPA.145(a) Establishment of minimum flight altitudes**

#### MINIMUM FLIGHT ALTITUDES

- (a) The following are examples of some of the methods available for calculating minimum flight altitudes.
- (b) KSS formula:
  - (1) Minimum obstacle clearance altitude (MOCA)
    - (i) MOCA is the sum of:
      - (A) the maximum terrain or obstacle elevation, whichever is higher; plus
      - (B) 1000 ft for elevation up to and including 6 000 ft; or
      - (C) 2000 ft for elevation exceeding 6000 ft rounded up to the next 100 ft.
    - (ii) The lowest MOCA to be indicated is 2 000 ft.
    - (iii) From a VOR station, the corridor width is defined as a borderline starting 5 NM either side of the VOR, diverging 4 NM from centreline until a width of 20 NM is reached at 70 NM out, thence paralleling the centreline until 140 NM out, thence again diverging 4 NM until a maximum width of 40 NM is reached at 280 NM out. Thereafter, the width remains constant (see Figure 1).

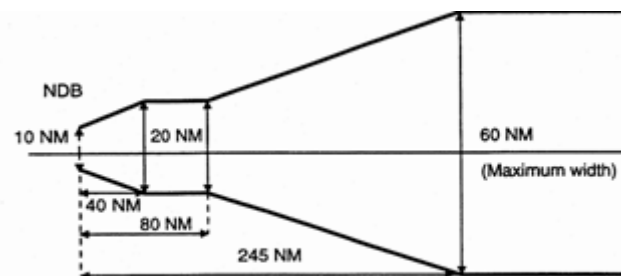
**Figure 1:** Corridor width from a VOR station





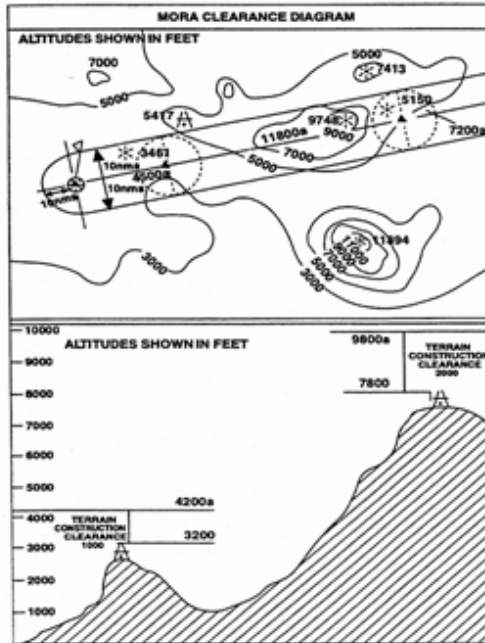
- (iv) From a non-directional beacon (NDB), similarly, the corridor width is defined as a borderline starting 5 NM either side of the NDB diverging 7 NM until a width of 20 NM is reached 40 NM out, thence paralleling the centreline until 80 NM out, thence again diverging 7 NM until a maximum width of 60 NM is reached 245 NM out. Thereafter, the width remains constant (see Figure 2).

**Figure 2:** Corridor width from an NDB



- (v) MOCA does not cover any overlapping of the corridor.
- (2) Minimum off- route altitude (MORA). MORA is calculated for an area bounded by each or every second LAT/LONG square on the route facility chart (RFC)/terminal approach chart (TAC) and is based on a terrain clearance as follows:
- (i) terrain with elevation up to 6 000 ft (2 000 m) – 1 000 ft above the highest terrain and obstructions;
  - (ii) terrain with elevation above 6 000 ft (2 000 m) – 2 000 ft above the highest terrain and obstructions.
- (c) Jeppesen formula (see Figure 3)
- (1) MORA is a minimum flight altitude computed by Jeppesen from current operational navigation charts (ONCs) or world aeronautical charts (WACs). Two types of MORAs are charted which are:
    - (i) route MORAs e.g. 9800a; and
    - (ii) grid MORAs e.g. 98.
  - (2) Route MORA values are computed on the basis of an area extending 10 NM to either side of route centreline and including a 10 NM radius beyond the radio fix/reporting point or mileage break defining the route segment.
  - (3) MORA values clear all terrain and man-made obstacles by 1 000 ft in areas where the highest terrain elevation or obstacles are up to 5 000 ft. A clearance of 2 000 ft is provided above all terrain or obstacles that are 5 001 ft and above.

- (4) A grid MORA is an altitude computed by Jeppesen and the values are shown within each grid formed by charted lines of latitude and longitude. Figures are shown in thousands and hundreds of feet (omitting the last two digits so as to avoid chart congestion). Values followed by ± are believed not to exceed the altitudes shown. The same clearance criteria as explained in (c)(3) apply.



(d) ATLAS formula

- (1) Minimum en-route altitude (MEA). Calculation of the MEA is based on the elevation of the highest point along the route segment concerned (extending from navigational aid to navigational aid) within a distance on either side of track as specified in Table 1 below:

**Table 1:** Minimum safe en- route altitude

Segment length	Distance either side of track
Up to 100 NM	10 NM *
More than 100 NM	10 % of segment length up to a maximum of 60 NM **

\*: This distance may be reduced to 5 NM within terminal control areas (TMAs) where, due to the number and type of available navigational aids, a high degree of navigational accuracy is warranted.

\*\* : In exceptional cases, where this calculation results in an operationally impracticable value, an additional special MEA may be calculated based on a distance of not less than 10 NM either side of track. Such special MEA will be shown together with an indication of the actual width of protected airspace.

- (2) The MEA is calculated by adding an increment to the elevation specified above as appropriate, following Table 2 below. The resulting value is adjusted to the nearest 100 ft.

Elevation of highest point	Increment
Not above 5 000 ft	1 500 ft
Above 5 000 ft but not above 10 000 ft	2 000 ft
Above 10 000 ft	10 % of elevation plus 1 000 ft

\*: *For the last route segment ending over the initial approach fix, a reduction to 1 000 ft is permissible within TMAs where, due to the number and type of available navigation aids, a high degree of navigational accuracy is warranted.*

- (3) Minimum safe grid altitude (MGA). Calculation of the MGA is based on the elevation of the highest point within the respective grid area.

The MGA is calculated by adding an increment to the elevation specified above as appropriate, following Table 3 below. The resulting value is adjusted to the nearest 100 ft.

**Table 3:** Minimum safe grid altitude

Elevation of highest point	Increment
Not above 5 000 ft	1 500 ft
Above 5 000 ft but not above 10 000 ft	2 000 ft
Above 10 000 ft	10 % of elevation plus 1 000 ft

- (e) Lido formula

- (1) Minimum terrain clearance altitude (MTCA)

The MTCA represents an altitude providing terrain and obstacle clearance for all airways/ATS routes, all standard terminal arrival route (STAR) segments up to IAF or equivalent end point and for selected standard instrument departures (SIDs).

The MTCA is calculated by Lido and covers terrain and obstacle clearance relevant for air navigation with the following buffers:

- (i) Horizontal:
- (A) for SID and STAR procedures 5 NM either side of centre line; and
  - (B) for airways/ATS routes 10 NM either side of centre line.
- (ii) Vertical:
- (A) 1 000 ft up to 6 000 ft; and
  - (B) 2 000 ft above 6 000 ft.

MTCA's are always shown in feet. The lowest indicated MTCA is 3 100 ft.

## (2) Minimum grid altitude (MGA)

MGA represents the lowest safe altitude which can be flown off-track. The MGA is calculated by rounding up the elevation of the highest obstruction within the respective grid area to the next 100 ft and adding an increment of

- (i) 1 000 ft for terrain or obstructions up to 6 000 ft; and
- (ii) 2 000 ft for terrain or obstructions above 6 000 ft.

MGA is shown in hundreds of feet. The lowest indicated MGA is 2 000 ft. This value is also provided for terrain and obstacles that would result in an MGA below 2 000 ft. An exception is over water areas where the MGA can be omitted.

**AMC1 CAT.OP.MPA.150(b) Fuel policy**

## PLANNING CRITERIA — AEROPLANES

The operator should base the defined fuel policy, including calculation of the amount of fuel to be on board for departure, on the following planning criteria:

## (a) Basic procedure

The usable fuel to be on board for departure should be the sum of the following:

- (1) Taxi fuel, which should not be less than the amount expected to be used prior to take-off. Local conditions at the departure aerodrome and auxiliary power unit (APU) consumption should be taken into account.
- (2) Trip fuel, which should include:
  - (i) fuel for take-off and climb from aerodrome elevation to initial cruising level/altitude, taking into account the expected departure routing;
  - (ii) fuel from top of climb to top of descent, including any step climb/descent;
  - (iii) fuel from top of descent to the point where the approach is initiated, taking into account the expected arrival procedure; and
  - (iv) fuel for approach and landing at the destination aerodrome.
- (3) Contingency fuel, except as provided for in (b), which should be the higher of:
  - (i) Either:
    - (A) 5 % of the planned trip fuel or, in the event of in-flight replanning, 5 % of the trip fuel for the remainder of the flight;
    - (B) not less than 3 % of the planned trip fuel or, in the event of in-flight replanning, 3 % of the trip fuel for the remainder of the flight, provided that an en-route alternate (ERA) aerodrome is available;
    - (C) an amount of fuel sufficient for 20 minutes flying time based upon the planned trip fuel consumption, provided that the operator has established a fuel consumption monitoring programme for individual aeroplanes and uses valid data determined by means of such a programme for fuel calculation; or
    - (D) an amount of fuel based on a statistical method that ensures an appropriate statistical coverage of the deviation from the planned to the actual trip fuel. This method is used to monitor the fuel consumption on each city pair/aeroplane combination and the operator uses this data for a statistical analysis to calculate contingency fuel for that city pair/aeroplane combination;
  - (ii) or an amount to fly for 5 minutes at holding speed at 1 500 ft (450 m), above the destination aerodrome in standard conditions.
- (4) Alternate fuel, which should:

- (i) include:
    - (A) fuel for a missed approach from the applicable DA/H or MDA/H at the destination aerodrome to missed approach altitude, taking into account the complete missed approach procedure;
    - (B) fuel for climb from missed approach altitude to cruising level/altitude, taking into account the expected departure routing;
    - (C) fuel for cruise from top of climb to top of descent, taking into account the expected routing;
    - (D) fuel for descent from top of descent to the point where the approach is initiated, taking into account the expected arrival procedure; and
    - (E) fuel for executing an approach and landing at the destination alternate aerodrome;
  - (ii) where two destination alternate aerodromes are required, be sufficient to proceed to the alternate aerodrome that requires the greater amount of alternate fuel.
- (5) Final reserve fuel, which should be:
- (i) for aeroplanes with reciprocating engines, fuel to fly for 45 minutes; or
  - (ii) for aeroplanes with turbine engines, fuel to fly for 30 minutes at holding speed at 1 500 ft (450 m) above aerodrome elevation in standard conditions, calculated with the estimated mass on arrival at the destination alternate aerodrome or the destination aerodrome, when no destination alternate aerodrome is required.
- (6) The minimum additional fuel, which should permit:
- (i) the aeroplane to descend as necessary and proceed to an adequate alternate aerodrome in the event of engine failure or loss of pressurisation, whichever requires the greater amount of fuel based on the assumption that such a failure occurs at the most critical point along the route, and
    - (A) hold there for 15 minutes at 1 500 ft (450 m) above aerodrome elevation in standard conditions; and
    - (B) make an approach and landing,except that additional fuel is only required if the minimum amount of fuel calculated in accordance with (a)(2) to (a)(5) is not sufficient for such an event; and
  - (ii) holding for 15 minutes at 1 500 ft (450 m) above destination aerodrome elevation in standard conditions, when a flight is operated without a destination alternate aerodrome.
- (7) Extra fuel, which should be at the discretion of the commander.
- (b) Reduced contingency fuel (RCF) procedure
- If the operator's fuel policy includes pre-flight planning to a destination 1 aerodrome (commercial destination) with an RCF procedure using a decision point along the route and a destination 2 aerodrome (optional refuel destination), the amount of usable fuel, on board for departure, should be the greater of (b)(1) or (b)(2):
- (1) The sum of:
- (i) taxi fuel;
  - (ii) trip fuel to the destination 1 aerodrome, via the decision point;
  - (iii) contingency fuel equal to not less than 5 % of the estimated fuel consumption from the decision point to the destination 1 aerodrome;

- (iv) alternate fuel or no alternate fuel if the decision point is at less than 6 hours from the destination 1 aerodrome and the requirements of CAT.OP.MPA.180(b)(2), are fulfilled;
  - (v) final reserve fuel;
  - (vi) additional fuel; and
  - (vii) extra fuel if required by the commander.
- (2) The sum of:
- (i) taxi fuel;
  - (ii) trip fuel to the destination 2 aerodrome, via the decision point;
  - (iii) contingency fuel equal to not less than the amount calculated in accordance with (a)(3) above from departure aerodrome to the destination 2 aerodrome;
  - (iv) alternate fuel, if a destination 2 alternate aerodrome is required;
  - (v) final reserve fuel;
  - (vi) additional fuel; and
  - (vii) extra fuel if required by the commander.
- (c) Predetermined point (PDP) procedure
- If the operator's fuel policy includes planning to a destination alternate aerodrome where the distance between the destination aerodrome and the destination alternate aerodrome is such that a flight can only be routed via a predetermined point to one of these aerodromes, the amount of usable fuel, on board for departure, should be the greater of (c)(1) or (c)(2):
- (1) The sum of:
- (i) taxi fuel;
  - (ii) trip fuel from the departure aerodrome to the destination aerodrome, via the predetermined point;
  - (iii) contingency fuel calculated in accordance with (a)(3);
  - (iv) additional fuel if required, but not less than:
    - (A) for aeroplanes with reciprocating engines, fuel to fly for 45 minutes plus 15 % of the flight time planned to be spent at cruising level or 2 hours, whichever is less; or
    - (B) for aeroplanes with turbine engines, fuel to fly for 2 hours at normal cruise consumption above the destination aerodrome, this should not be less than final reserve fuel; and
  - (v) extra fuel if required by the commander.
- (2) The sum of:
- (i) taxi fuel;
  - (ii) trip fuel from the departure aerodrome to the destination alternate aerodrome, via the predetermined point;
  - (iii) contingency fuel calculated in accordance with (a)(3);
  - (iv) additional fuel if required, but not less than:
    - (A) for aeroplanes with reciprocating engines: fuel to fly for 45 minutes; or
    - (B) for aeroplanes with turbine engines: fuel to fly for 30 minutes at holding speed at 1 500 ft (450 m) above the destination alternate aerodrome elevation in standard conditions, this should not be less than final reserve fuel; and
  - (v) extra fuel if required by the commander.

(d) Isolated aerodrome procedure

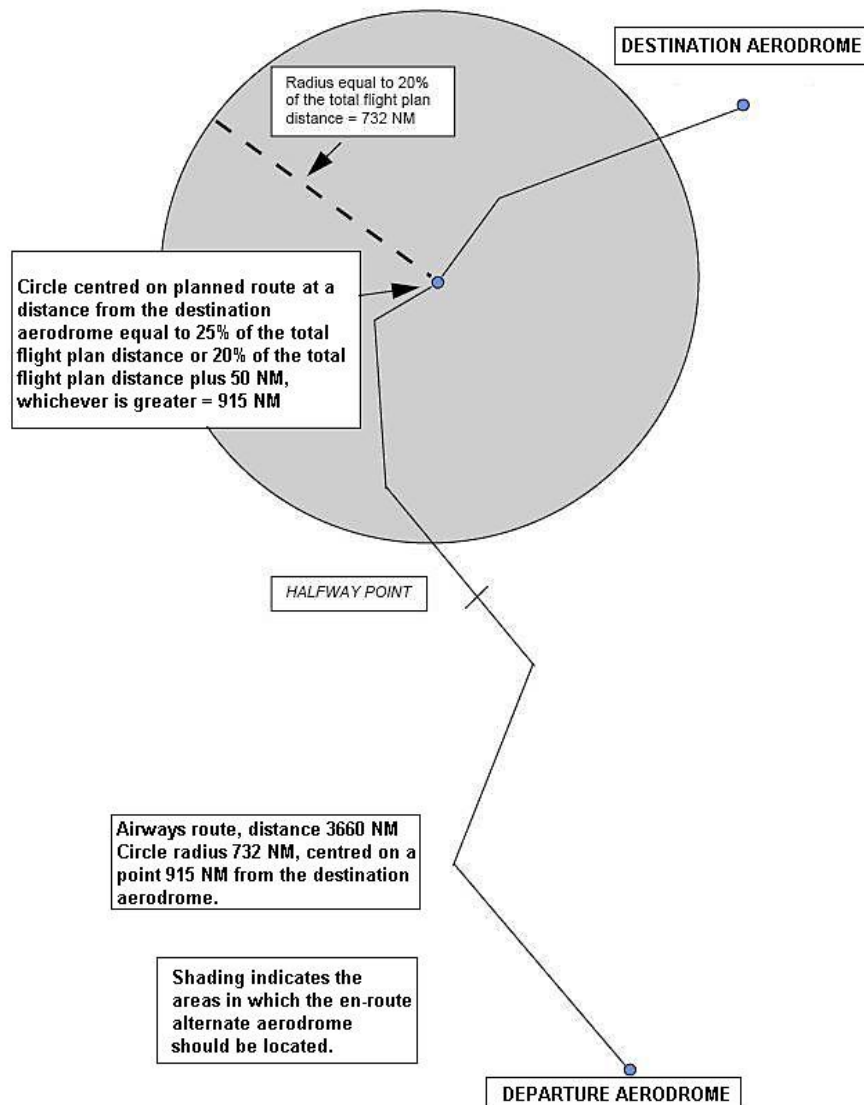
If the operator's fuel policy includes planning to an isolated aerodrome, the last possible point of diversion to any available en-route alternate (ERA) aerodrome should be used as the predetermined point.

**AMC2 CAT.OP.MPA.150(b) Fuel policy**

LOCATION OF THE FUEL EN-ROUTE ALTERNATE (FUEL ERA) AERODROME

- (a) The fuel ERA aerodrome should be located within a circle having a radius equal to 20 % of the total flight plan distance, the centre of which lies on the planned route at a distance from the destination aerodrome of 25 % of the total flight plan distance, or at least 20 % of the total flight plan distance plus 50 NM, whichever is greater. All distances should be calculated in still air conditions (see Figure 1).

**Figure 1:** Location of the fuel ERA aerodrome for the purposes of reducing contingency fuel to 3 %



### AMC3 CAT.OP.MPA.150(b) Fuel policy

#### PLANNING CRITERIA — HELICOPTERS

The operator should base the company fuel policy, including calculation of the amount of fuel to be carried, on the following planning criteria:

- (a) The amount of:
  - (1) taxi fuel, which should not be less than the amount expected to be used prior to take-off. Local conditions at the departure site and APU consumption should be taken into account;
  - (2) trip fuel, which should include fuel:
    - (i) for take-off and climb from aerodrome elevation to initial cruising level/altitude, taking into account the expected departure routing;



- (ii) from top of climb to top of descent, including any step climb/descent;
  - (iii) from top of descent to the point where the approach procedure is initiated, taking into account the expected arrival procedure; and
  - (iv) for approach and landing at the destination site;
  - (3) contingency fuel, which should be:
    - (i) for IFR flights, or for VFR flights in a hostile environment, 10 % of the planned trip fuel; or
    - (ii) for VFR flights in a non-hostile environment, 5 % of the planned trip fuel;
  - (4) alternate fuel, which should be:
    - (i) fuel for a missed approach from the applicable MDA/DH at the destination aerodrome to missed approach altitude, taking into account the complete missed approach procedure;
    - (ii) fuel for a climb from missed approach altitude to cruising level/altitude;
    - (iii) fuel for the cruise from top of climb to top of descent;
    - (iv) fuel for descent from top of descent to the point where the approach is initiated, taking into account the expected arrival procedure;
    - (v) fuel for executing an approach and landing at the destination alternate selected in accordance with CAT.OP.MPA.181; and
    - (vi) for helicopters operating to or from helidecks located in a hostile environment, 10 % of (a)(4)(i) to (v);
  - (5) final reserve fuel, which should be:
    - (i) for VFR flights navigating by day with reference to visual landmarks, 20 minutes' fuel at best range speed; or
    - (ii) for IFR flights or when flying VFR and navigating by means other than by reference to visual landmarks or at night, fuel to fly for 30 minutes at holding speed at 1 500 ft (450 m) above the destination aerodrome in standard conditions calculated with the estimated mass on arrival above the alternate, or the destination, when no alternate is required; and
  - (6) extra fuel, which should be at the discretion of the commander.
- (b) Isolated aerodrome IFR procedure
- If the operator's fuel policy includes planning to an isolated aerodrome flying IFR, or when flying VFR and navigating by means other than by reference to visual landmarks, for which a destination alternate does not exist, the amount of fuel at departure should include:
- (1) taxi fuel;
  - (2) trip fuel;
  - (3) contingency fuel calculated in accordance with (a)(3);
  - (4) additional fuel to fly for 2 hours at holding speed, including final reserve fuel; and
  - (5) extra fuel at the discretion of the commander.
- (c) Sufficient fuel should be carried at all times to ensure that following the failure of an engine occurring at the most critical point along the route, the helicopter is able to:
- (1) descend as necessary and proceed to an adequate aerodrome;
  - (2) hold there for 15 minutes at 1 500 ft (450 m) above aerodrome elevation in standard conditions; and

- (3) make an approach and landing.

### **GM1 CAT.OP.MPA.150(b) Fuel policy**

#### CONTINGENCY FUEL STATISTICAL METHOD — AEROPLANES

- (a) As an example, the following values of statistical coverage of the deviation from the planned to the actual trip fuel provide appropriate statistical coverage.
- (1) 99 % coverage plus 3 % of the trip fuel, if the calculated flight time is less than 2 hours, or more than 2 hours and no weather-permissible ERA aerodrome is available.
  - (2) 99 % coverage if the calculated flight time is more than 2 hours and a weather-permissible ERA aerodrome is available.
  - (3) 90 % coverage if:
    - (i) the calculated flight time is more than 2 hours;
    - (ii) a weather-permissible ERA aerodrome is available; and
    - (iii) at the destination aerodrome two separate runways are available and usable, one of which is equipped with an ILS/MLS, and the weather conditions are in compliance with CAT.OP.MPA.180(b)(2), or the ILS/MLS is operational to CAT II/III operating minima and the weather conditions are at or above 500 ft.
- (b) The fuel consumption database used in conjunction with these values should be based on fuel consumption monitoring for each route/aeroplane combination over a rolling 2- year period.

### **GM1 CAT.OP.MPA.150(c)(3)(i) Fuel policy**

#### CONTINGENCY FUEL

Factors that may influence fuel required on a particular flight in an unpredictable way include deviations of an individual aeroplane from the expected fuel consumption data, deviations from forecast meteorological conditions and deviations from planned routings and/or cruising levels/altitudes.

### **GM1 CAT.OP.MPA.150(c)(3)(ii) Fuel policy**

#### DESTINATION ALTERNATE AERODROME

The departure aerodrome may be selected as the destination alternate aerodrome.

### **AMC1 CAT.OP.MPA.155(b) Carriage of special categories of passengers (SCPs)**

#### PROCEDURES

When establishing the procedures for the carriage of **SCPs**, the operator should take into account the following factors:

- (a) the aircraft type and cabin configuration;
- (b) the total number of passengers carried on board;
- (c) the number and categories of SCPs, which should not exceed the number of passengers capable of assisting them in case of an emergency evacuation; and
- (d) any other factor(s) or circumstances possibly impacting on the application of emergency procedures by the operating crew members.

### **AMC2 CAT.OP.MPA.155(b) Carriage of Special Categories of Passengers (SCPs)**

#### PROCEDURES TO PROVIDE INFORMATION TO SCP

The operator procedures on information provided to the SCP should specify the timing and methods on how and when the information can be provided.

### **AMC3 CAT.OP.MPA.155(b) Carriage of Special Categories of Passengers (SCPs)**

#### CONDITIONS OF SAFE CARRIAGE FOR UNACCOMPANIED CHILDREN

- (a) When carrying an unaccompanied child that is not self-reliant, the operator should assess the safety risks to ensure that the child is assisted in case of an emergency situation.
- (b) A child under the age of 12 years, separated from the accompanying adult, who is travelling in another cabin class, should be considered as an unaccompanied child in order to ensure that the child is assisted in case of an emergency situation.

### **GM1 CAT.OP.MPA.155(b) Carriage of Special Categories of Passengers (SCPs)**

#### PROCEDURES TO PROVIDE INFORMATION TO SCP

Providing information only at the time of booking might not be sufficient to ensure that the SCP is aware of the information at the time of the flight.

### **GM2 CAT.OP.MPA.155(b) Carriage of Special Categories of Passengers (SCPs)**

#### INFORMATION PROVIDED TO SCP

When establishing procedures on the information to be provided to an SCP, the operator should consider informing the SCP that cabin crew can only assist the SCP once the cabin has been evacuated. The following table contains additional information by SCP category:

SCP category	Type of information
Unaccompanied child	<p>Inform the unaccompanied child on the following:</p> <ul style="list-style-type: none"> <li>(a) which adult will assist with the operation of the seat belt and the fitting of the oxygen mask if the situation requires it;</li> <li>(b) the content of the passenger safety briefing card; and</li> <li>(c) in case of evacuation, to seek the assistance of adult passenger(s) in contacting a crew member.</li> </ul> <p>Inform the passenger sitting next to the unaccompanied child to assist with:</p> <ul style="list-style-type: none"> <li>(a) providing the child with an oxygen mask in case of decompression after fitting one's own mask;</li> <li>(b) securing/releasing the child's seat belt, if necessary; and</li> <li>(c) calling a cabin crew member in all other in-flight situations.</li> </ul> <p>When a child and the accompanying adult travel in a different class of cabin, information should be provided to the child and adult that, in the event of an emergency, they should follow the instructions of the cabin crew and not try to reunite inside the cabin as this would slow down the overall evacuation</p>
Adult travelling with an infant	<p>Information on brace position for adult with lap-held infant. Information on the use of the loop belt, in case of a lap-held infant.</p> <p>Information to fit own oxygen mask before fitting the infant's oxygen mask.</p> <p>Information on how to evacuate when carrying an infant:</p> <ul style="list-style-type: none"> <li>(a) On land, jump on the slide; and</li> <li>(b) In case of ditching, how to fit and when to inflate infant flotation aid</li> </ul>

	(e.g. life vest, flotation device).
Physically disabled passenger (aided walking)	Inform the SCP to leave mobility aid behind in an emergency evacuation.
Passenger with disability of upper limbs	Inform the accompanying passenger to: <ul style="list-style-type: none"> <li>(a) fit the life jacket on the SCP, in case of a ditching evacuation;</li> <li>(b) first put on their own oxygen mask before fitting the SCP's oxygen mask, in case of decompression; and</li> <li>(c) secure/release the SCP's seat belt, if necessary.</li> </ul>
Passenger with disability of lower limbs	Inform the SCP: <ul style="list-style-type: none"> <li>(a) on the location of the nearest suitable exit; and</li> <li>(b) that mobility aids might not be accessible in an emergency evacuation.</li> </ul>
Passenger with disability of both upper and lower limbs	Inform accompanying passenger to secure/release the SCP's seat belt. Inform the SCP: <ul style="list-style-type: none"> <li>(a) in case of an evacuation, on the location of the nearest suitable exit;</li> <li>(b) in case of a ditching evacuation, that the accompanying passenger should fit the life jacket on the SCP; and</li> <li>(c) in case of a decompression, that the accompanying passenger should first put on his/her own oxygen mask before fitting the SCP's oxygen mask.</li> </ul>
Visually impaired passenger	Depending on the level of impairment, inform the visually impaired passenger on the following: <ul style="list-style-type: none"> <li>(a) seat and seat belt operation;</li> <li>(b) location of the nearest exit (e.g. number of seat rows to the nearest exit);</li> <li>(c) oxygen mask deployment;</li> <li>(d) location of life jacket;</li> <li>(e) brace position; and</li> <li>(f) location of cabin crew call button.</li> </ul> If available, take the aircraft demonstration equipment to the passenger for tactile assistance.
Passenger travelling with a recognised assistance dog in the cabin	Advise how to evacuate guide dog by holding the dog and sliding.
Stretcher occupant	Inform the stretcher occupant and the accompanying passenger that in case of an evacuation: <ul style="list-style-type: none"> <li>(a) the stretcher occupant should be evacuated when the cabin area surrounding the stretcher is clear;</li> <li>(b) to evacuate the stretcher occupant without the stretcher, if possible;</li> <li>(c) to be seated when sliding, holding the stretcher occupant in front; and</li> <li>(d) in the event of a ditching evacuation, to fit the life jacket on the stretcher occupant.</li> </ul>

### **GM3 CAT.OP.MPA.155(b) Carriage of Special Categories of Passengers (SCPs)**

#### **PROCEDURES**

A passenger capable of assisting in case of an emergency means a passenger who is not an SCP and has no other role or private responsibility that would prevent him/her from assisting the SCP. For example, an adult travelling alone has no other role or private responsibility, unlike a family travelling together with younger children.

**GM4 CAT.OP.MPA.155(b) Carriage of Special Categories of Passengers (SCPs)****BRIEFING PROCEDURE IN A PLANNED EMERGENCY**

In a planned emergency, if time permits, passengers identified by the cabin crew as capable of assisting an SCP should be briefed on the assistance they can provide.

**AMC1 CAT.OP.MPA.155(c) Carriage of Special Categories of Passengers (SCPs)****SEATING PROCEDURES**

When establishing SCP seating procedures, the operator should take into account the following factors:

- (a) If the SCP travels with an accompanying passenger, the accompanying passenger should be seated next to the SCP.
- (b) If the SCP is unable to negotiate stairs within the cabin unaided, he/she should not be seated on the upper deck of a multi-deck aircraft if the exits are not certified for emergency evacuation on both land and water.

**AMC2 CAT.OP.MPA.155(c) Carriage of Special Categories of Passengers (SCPs)****SEATING ALLOCATION OF SCP WITH A DISABILITY AND/OR RESTRAINT AID**

- (a) A disability and/or restraint aid that requires to be secured around the back of the seat should not be used if there is a person seated behind unless the seating configuration is approved for the use of such devices. This is to avoid the changed dynamic seat reactions with the disability and/or restraint aid, which may lead to head injury of the passenger seated behind.
- (b) If the seat design or installation would prevent head contact of the person seated behind, then no further consideration is necessary.

**GM1 CAT.OP.MPA.155(c) Carriage of Special categories of Passengers (SCPs)****GROUP SEATING**

- (a) Taking into account access to exits, groups of non-ambulatory SCPs should be seated throughout the cabin to ensure that each SCP is surrounded by the maximum number of passengers capable of assisting in case of an emergency.
- (b) If non-ambulatory SCPs cannot be evenly distributed throughout the cabin, the operator should establish procedures to mitigate the increased safety risk such as seating of passengers capable of assisting in case of an emergency in the vicinity, additional information or training of cabin crew.
- (c) A group of passengers whose physical size would possibly prevent them from moving quickly or reaching and passing through an emergency exit, should not occupy the same seat row segment to avoid overloading the structure of the seat.

**GM2 CAT.OP.MPA.155(c) Carriage of Special Categories of Passengers (SCPs)****SEATING ALLOCATION**

When establishing the procedure on seating of an SCP, seats should be allocated taking into account the following:

SCP category	Seating allocation procedure
--------------	------------------------------

Unaccompanied child	<p>The seating allocation of an unaccompanied child should allow for visual or audible communication during all phases of the flight with cabin crew.</p> <p>Groups of unaccompanied children should be seated in mix of ages, with the tallest child seated to allow assistance with fitting drop-down oxygen mask to smaller children in case of a decompression.</p> <p>Where possible, one adult should occupy the seat across the aisle next to each row of unaccompanied children.</p>
Passenger travelling with a child of less than 12 years of age	If a child travels with an accompanying adult in the same class of cabin, the child should be seated in the same seat row segment as the accompanying adult. Where this is not possible, the child should be seated no more than one seat row or aisle away.
Passenger whose physical size would possibly prevent him/her from passing through an emergency exit	<p>A passenger whose physical size would possibly prevent him/her from passing through an emergency exit (e.g. Type III or Type IV exit), should be seated in the vicinity of a suitable exit, taking into account the size of the exit.</p> <p>Seating of more than one of such passengers in the same seat row segment should be avoided.</p>
Passenger with physical disability of the upper limbs	A passenger with a physical disability of the upper limbs travelling without an accompanying passenger should be allocated seats during all phases of the flight so that visual and audible communication can be established with the cabin crew.
Passenger with disability of lower limbs	A passenger with a disability of the lower limbs should be seated in a location providing easy access to floor level exits.
Passenger with disability of both upper and lower limbs	A passenger with a disability of both upper and lower limbs should be seated in a location providing easy access to floor level exits.
Mentally impaired passenger	A mentally impaired passenger, who travels without an accompanying passenger, should be allocated seats during all phases of the flight so that visual and audible communication can be established with the cabin crew.
Passenger travelling with recognised assistance dog in the cabin	Suitable arrangements should be made between the passenger and the operator in advance of a flight where a recognised assistance dog is to be accommodated. A suitable restraint harness should be provided by the owner to secure and restrain the dog during taxi, take-off, landing and turbulence. In cruise, it is acceptable for the dog to be subject to less restraint.
Stretcher occupant	Where possible, the stretcher should be installed behind a cabin monument. Alternatively, the stretcher could be installed where it can demonstrate compliance with the appropriate certification basis. Stretcher installation should be as close to the floor level non-overwing exits as practical; preferably close to a required cabin crew station with an adjacent seat for the designated accompanying passenger.

## AMC1 CAT.OP.MPA.160 Stowage of baggage and cargo

### STOWAGE PROCEDURES

Procedures established by the operator to ensure that hand baggage and cargo are adequately and securely stowed should take account of the following:

- (a) each item carried in a cabin should be stowed only in a location that is capable of restraining it;

- (b) weight limitations placarded on or adjacent to stowages should not be exceeded;
- (c) under seat stowages should not be used unless the seat is equipped with a restraint bar and the baggage is of such size that it may adequately be restrained by this equipment;
- (d) items should not be stowed in lavatories or against bulkheads that are incapable of restraining articles against movement forwards, sideways or upwards and unless the bulkheads carry a placard specifying the greatest mass that may be placed there;
- (e) baggage and cargo placed in lockers should not be of such size that they prevent latched doors from being closed securely;
- (f) baggage and cargo should not be placed where it can impede access to emergency equipment; and
- (g) checks should be made before take-off, before landing and whenever the 'fasten seat belts' signs are illuminated or it is otherwise so ordered to ensure that baggage is stowed where it cannot impede evacuation from the aircraft or cause injury by falling (or other movement), as may be appropriate to the phase of flight.

### **AMC2 CAT.OP.MPA.160 Stowage of baggage and cargo**

#### CARRIAGE OF CARGO IN THE PASSENGER COMPARTMENT

The following should be observed before carrying cargo in the passenger compartment:

- (a) for aeroplanes:
  - (1) dangerous goods should not be allowed; and
  - (2) a mix of passengers and live animals should only be allowed for pets weighing not more than 8 kg and guide dogs;
- (b) for aeroplanes and helicopters:
  - (1) the mass of cargo should not exceed the structural loading limits of the floor or seats;
  - (2) the number/type of restraint devices and their attachment points should be capable of restraining the cargo in accordance with applicable certification specifications; and
  - (3) the location of the cargo should be such that, in the event of an emergency evacuation, it will not hinder egress nor impair the crew's view.

### **AMC1 CAT.OP.MPA.165 Passenger seating**

#### PROCEDURES

The operator should make provision so that:

- (a) those passengers who are allocated seats that permit direct access to emergency exits appear to be reasonably fit, strong and able to assist the rapid evacuation of the aircraft in an emergency after an appropriate briefing by the crew;
- (b) in all cases, passengers who, because of their condition, might hinder other passengers during an evacuation or who might impede the crew in carrying out their duties, should not be allocated seats that permit direct access to emergency exits. If procedures cannot be reasonably implemented at the time of passenger 'check-in', the operator should establish an alternative procedure which ensures that the correct seat allocations will, in due course, be made.

### **AMC2 CAT.OP.MPA.165 Passenger seating**

#### ACCESS TO EMERGENCY EXITS

The following categories of passengers are among those who should not be allocated to, or directed to, seats that permit direct access to emergency exits:

- (a) passengers suffering from obvious physical or mental disability to the extent that they would have difficulty in moving quickly if asked to do so;
- (b) passengers who are either substantially blind or substantially deaf to the extent that they might not readily assimilate printed or verbal instructions given;
- (c) passengers who because of age or sickness are so frail that they have difficulty in moving quickly;
- (d) passengers who are so obese that they would have difficulty in moving quickly or reaching and passing through the adjacent emergency exit;
- (e) children (whether accompanied or not) and infants;
- (f) deportees, inadmissible passengers or persons in custody; and
- (g) passengers with animals.

### **GM1 CAT.OP.MPA.165 Passenger seating**

#### **DIRECT ACCESS**

'Direct access' means a seat from which a passenger can proceed directly to the exit without entering an aisle or passing around an obstruction.

### **AMC1 CAT.OP.MPA.170 Passenger briefing**

#### **PASSENGER BRIEFING**

Passenger briefings should contain the following:

- (a) Before take-off
  - (1) Passengers should be briefed on the following items if applicable:
    - (i) smoking regulations;
    - (ii) back of the seat to be in the upright position and tray table stowed;
    - (iii) location of emergency exits;
    - (iv) location and use of floor proximity escape path markings;
    - (v) stowage of hand baggage;
    - (vi) the use and stowage of portable electronic devices; and
    - (vii) the location and the contents of the safety briefing card; and
  - (2) passengers should receive a demonstration of the following:
    - (i) the use of safety belts or restraint systems, including how to fasten and unfasten the safety belts or restraint systems;
    - (ii) the location and use of oxygen equipment, if required. Passengers should also be briefed to extinguish all smoking materials when oxygen is being used; and
    - (iii) the location and use of life-jackets, if required.
- (b) After take-off
  - (1) passengers should be reminded of the following, if applicable:
    - (i) smoking regulations; and
    - (ii) use of safety belts or restraint systems including the safety benefits of having safety belts fastened when seated irrespective of seat belt sign illumination.
- (c) Before landing
  - (1) passengers should be reminded of the following, if applicable:
    - (i) smoking regulations;
    - (ii) use of safety belts or restraint systems;
    - (iii) back of the seat to be in the upright position and tray table stowed;



- (iv) re-stowage of hand baggage; and
- (v) the use and stowage of portable electronic devices.
- (d) After landing
  - (1) passengers should be reminded of the following:
    - (i) smoking regulations; and
    - (ii) use of safety belts and/or restraint systems.
- (e) Emergency during flight:
  - (1) passengers should be instructed as appropriate to the circumstances.

### **AMC1.1 CAT.OP.MPA.170 Passenger briefing**

#### PASSENGER BRIEFING

- (a) The operator may replace the briefing/demonstration as set out in AMC1 CAT.OP.MPA.170 with a passenger training programme covering all safety and emergency procedures for a given type of aircraft.
- (b) Only passengers who have been trained according to this programme and have flown on the aircraft type within the last 90 days may be carried on board without receiving a briefing/demonstration.

### **AMC2 CAT.OP.MPA.170 Passenger briefing**

#### SINGLE-PILOT OPERATIONS WITHOUT CABIN CREW

For single-pilot operations without cabin crew, the commander should provide safety briefings to passengers except during critical phases of flight and taxiing.

### **AMC1 CAT.OP.MPA.175 Flight preparation**

#### FLIGHT PREPARATION FOR PBN OPERATIONS

- (a) The flight crew should ensure that RNAV 1, RNAV 2, RNP 1 RNP 2, and RNP APCH routes or procedures to be used for the intended flight, including for any alternate aerodromes, are selectable from the navigation database and are not prohibited by NOTAM.
- (b) The flight crew should take account of any NOTAMs or operator briefing material that could adversely affect the aircraft system operation along its flight plan including any alternate aerodromes.
- (c) When PBN relies on GNSS systems for which RAIM is required for integrity, its availability should be verified during the preflight planning. In the event of a predicted continuous loss of fault detection of more than five minutes, the flight planning should be revised to reflect the lack of full PBN capability for that period.
- (d) For RNP 4 operations with only GNSS sensors, a fault detection and exclusion (FDE) check should be performed. The maximum allowable time for which FDE capability is projected to be unavailable on any one event is 25 minutes. If predictions indicate that the maximum allowable FDE outage will be exceeded, the operation should be rescheduled to a time when FDE is available.
- (e) For RNAV 10 operations, the flight crew should take account of the RNAV 10 time limit declared for the inertial system, if applicable, considering also the effect of weather conditions that could affect flight duration in RNAV 10 airspace. Where an extension to the time limit is permitted, the flight crew will need to ensure that en route radio facilities are serviceable before departure, and to apply radio updates in accordance with any AFM limitation.

### **AMC2 CAT.OP.MPA.175 Flight preparation**

#### DATABASE SUITABILITY

- (a) The flight crew should check that any navigational database required for PBN operations includes the routes and procedures required for the flight.

#### DATABASE CURRENCY

- (b) The database validity (current AIRAC cycle) should be checked before the flight.
- (c) Navigation databases should be current for the duration of the flight. If the AIRAC cycle is due to change during flight, the flight crew should follow procedures established by the operator to ensure the accuracy of navigation data, including the suitability of navigation facilities used to define the routes and procedures for the flight.
- (d) An expired database may only be used if the following conditions are satisfied:
- (1) the operator has confirmed that the parts of the database which are intended to be used during the flight and any contingencies that are reasonable to expect are not changed in the current version;
  - (2) any NOTAMs associated with the navigational data are taken into account;
  - (3) maps and charts corresponding to those parts of the flight are current and have not been amended since the last cycle;
  - (4) any MEL limitations are observed; and
  - (5) the database has expired by no more than 28 day

### **AMC1 CAT.OP.MPA.175(a) Flight preparation**

#### OPERATIONAL FLIGHT PLAN — COMPLEX MOTOR-POWERED AIRCRAFT

- (a) The operational flight plan used and the entries made during flight should contain the following items:
- (1) aircraft registration;
  - (2) aircraft type and variant;
  - (3) date of flight;
  - (4) flight identification;
  - (5) names of flight crew members;
  - (6) duty assignment of flight crew members;
  - (7) place of departure;
  - (8) time of departure (actual off-block time, take-off time);
  - (9) place of arrival (planned and actual);
  - (10) time of arrival (actual landing and on- block time);
  - (11) type of operation (ETOPS, VFR, ferry flight, etc.);
  - (12) route and route segments with checkpoints/waypoints, distances, time and tracks;
  - (13) planned cruising speed and flying times between check-points/waypoints (estimated and actual times overhead);
  - (14) safe altitudes and minimum levels;
  - (15) planned altitudes and flight levels;
  - (16) fuel calculations (records of in-flight fuel checks);
  - (17) fuel on board when starting engines;
  - (18) alternate(s) for destination and, where applicable, take- off and en- route, including information required in (a)(12) to (15);
  - (19) initial ATS flight plan clearance and subsequent reclearance;
  - (20) in-flight replanning calculations; and
  - (21) relevant meteorological information.

- (b) Items that are readily available in other documentation or from another acceptable source or are irrelevant to the type of operation may be omitted from the operational flight plan.
- (c) The operational flight plan and its use should be described in the operations manual.
- (d) All entries on the operational flight plan should be made concurrently and be permanent in nature.

#### OPERATIONAL FLIGHT PLAN — OTHER-THAN- COMPLEX MOTOR- POWERED AIRCRAFT OPERATIONS AND LOCAL OPERATIONS

An operational flight plan may be established in a simplified form relevant to the kind of operation for operations with other-than-complex motor-powered aircraft as well as local operations with any aircraft.

#### **GM1 CAT.OP.MPA.175(b)(5) Flight preparation**

##### CONVERSION TABLES

The documentation should include any conversion tables necessary to support operations where metric heights, altitudes and flight levels are used.

#### **AMC1 CAT.OP.MPA.181(b)(1) Selection of aerodromes and operating sites — helicopters**

##### COASTAL AERODROME

- (a) Any alleviation from the requirement to select an alternate aerodrome for a flight to a coastal aerodrome under IFR routing from offshore should be based on an individual safety case assessment.
- (b) The following should be taken into account:
  - (1) suitability of the weather based on the landing forecast for the destination;
  - (2) the fuel required to meet the IFR requirements of CAT.OP.MPA.150 less alternate fuel;
  - (3) where the destination coastal aerodrome is not directly on the coast it should be:
    - (i) within a distance that, with the fuel specified in (b)(2), the helicopter can, at any time after crossing the coastline, return to the coast, descend safely and carry out a visual approach and landing with VFR fuel reserves intact; and
    - (ii) geographically sited so that the helicopter can, within the rules of the air, and within the landing forecast:
      - (A) proceed inbound from the coast at 500 ft AGL and carry out a visual approach and landing; or
      - (B) proceed inbound from the coast on an agreed route and carry out a visual approach and landing;
  - (4) procedures for coastal aerodromes should be based on a landing forecast no worse than:
    - (i) by day, a cloud base of DH/MDH +400 ft, and a visibility of 4 km, or, if descent over the sea is intended, a cloud base of 600 ft and a visibility of 4 km; or
    - (ii) by night, a cloud base of 1 000 ft and a visibility of 5 km;
  - (5) the descent to establish visual contact with the surface should take place over the sea or as part of the instrument approach;
  - (6) routings and procedures for coastal aerodromes nominated as such should be included in the operations manual, Part C;

- (7) the MEL should reflect the requirement for airborne radar and radio altimeter for this type of operation; and
- (8) operational limitations for each coastal aerodrome should be specified in the operations manual.

### **GM1CAT.OP.MPA.181 Selection of aerodromes and operating sites—helicopters**

#### OFFSHORE ALTERNATES

When operating offshore, any spare payload capacity should be used to carry additional fuel if it would facilitate the use of an onshore alternate aerodrome.

#### LANDING FORECAST

- (a) Meteorological data have been specified that conform to the standards contained in the Regional Air Navigation Plan and ICAO Annex 3. As the following meteorological data are point-specific, caution should be exercised when associating it with nearby aerodromes (or helidecks).
- (b) Meteorological reports (METARs)
  - (1) Routine and special meteorological observations at offshore installations should be made during periods and at a frequency agreed between the meteorological authority and the operator concerned. They should comply with the provisions contained in the meteorological section of the ICAO Regional Air Navigation Plan, and should conform to the standards and recommended practices, including the desirable accuracy of observations, promulgated in ICAO Annex 3.
  - (2) Routine and selected special reports are exchanged between meteorological offices in the METAR or SPECI (aviation selected special weather report) code forms prescribed by the World Meteorological Organisation.
- (c) Aerodrome forecasts (TAFs)
  - (1) The aerodrome forecast consists of a concise statement of the mean or average meteorological conditions expected at an aerodrome or aerodrome during a specified period of validity, which is normally not less than 9 hours, or more than 24 hours in duration. The forecast includes surface wind, visibility, weather and cloud, and expected changes of one or more of these elements during the period. Additional elements may be included as agreed between the meteorological authority and the operators concerned. Where these forecasts relate to offshore installations, barometric pressure and temperature should be included to facilitate the planning of helicopter landing and take-off performance.
  - (2) Aerodrome forecasts are most commonly exchanged in the TAF code form, and the detailed description of an aerodrome forecast is promulgated in the ICAO Regional Air Navigation Plan and also in ICAO Annex 3, together with the operationally desirable accuracy elements. In particular, the observed cloud height should remain within  $\pm 30\%$  of the forecast value in 70 % of cases, and the observed visibility should remain within  $\pm 30\%$  of the forecast value in 80 % of cases.
- (d) Landing forecasts (TRENDS)
  - (1) The landing forecast consists of a concise statement of the mean or average meteorological conditions expected at an aerodrome or aerodrome during the two-hour period immediately following the time of issue. It contains surface wind, visibility, significant weather and cloud elements and other significant information, such as barometric pressure and temperature, as may be agreed between the meteorological authority and the operators concerned.

- (2) The detailed description of the landing forecast is promulgated in the ICAO Regional Air Navigation Plan and also in ICAO Annex 3, together with the operationally desirable accuracy of the forecast elements. In particular, the value of the observed cloud height and visibility elements should remain within  $\pm 30\%$  of the forecast values in 90 % of the cases.
- (3) Landing forecasts most commonly take the form of routine or special selected meteorological reports in the METAR code, to which either the code words 'NOSIG', i.e. no significant change expected; 'BECMG' (becoming), or 'TEMPO' (temporarily), followed by the expected change, are added. The 2-hour period of validity commences at the time of the meteorological report.

### **AMC1 CAT.OP.MPA.181(d) Selection of aerodromes and operating sites — helicopters**

#### OFFSHORE ALTERNATES

- (a) Offshore alternate helideck landing environment

The landing environment of a helideck that is proposed for use as an offshore alternate should be pre-surveyed and, as well as the physical characteristics, the effect of wind direction and strength, and turbulence established. This information, which should be available to the commander at the planning stage and in flight, should be published in an appropriate form in the operations manual Part C (including the orientation of the helideck) such that the suitability of the helideck for use as an offshore alternate aerodrome can be assessed. The alternate helideck should meet the criteria for size and obstacle clearance appropriate to the performance requirements of the type of helicopter concerned.

- (b) Performance considerations

The use of an offshore alternate is restricted to helicopters which can achieve OEI in ground effect (IGE) hover at an appropriate power rating at the offshore alternate aerodrome. Where the surface of the offshore alternate helideck, or prevailing conditions (especially wind velocity), precludes an OEI IGE, OEI out of ground effect (OGE) hover performance at an appropriate power rating should be used to compute the landing mass. The landing mass should be calculated from graphs provided in the relevant Part B of the operations manual. When arriving at this landing mass, due account should be taken of helicopter configuration, environmental conditions and the operation of systems that have an adverse effect on performance. The planned landing mass of the helicopter including crew, passengers, baggage, cargo plus 30 minutes final reserve fuel, should not exceed the OEI landing mass at the time of approach to the offshore alternate aerodrome.

- (c) Weather considerations

- (1) Meteorological observations

When the use of an offshore alternate helideck is planned, the meteorological observations at the destination and alternate aerodrome should be taken by an observer acceptable to the authority responsible for the provision of meteorological services. Automatic meteorological observations stations may be used.

- (2) Weather minima

When the use of an offshore alternate helideck is planned, the operator should not select a helideck as a destination or offshore alternate helideck unless the aerodrome forecast indicates that, during a period commencing 1 hour before and ending 1 hour after the expected time of arrival at the destination and offshore alternate aerodrome, the weather conditions will be at or above the planning minima shown in Table 1 below.

**Table 1: Planning minima**

	Day	Night
Cloud Base	600 ft	800 ft
Visibility	4 km	5 km

## (3) Conditions of fog

Where fog is forecast, or has been observed within the last 2 hours within 60 NM of the destination or alternate aerodrome, offshore alternate aerodromes should not be used.

## (d) Actions at point of no return

Before passing the point of no return — which should not be more than 30 minutes from the destination — the following actions should have been completed:

- (1) confirmation that navigation to the destination and offshore alternate helideck can be assured;
- (2) radio contact with the destination and offshore alternate helideck (or master station) has been established;
- (3) the landing forecast at the destination and offshore alternate helideck have been obtained and confirmed to be at or above the required minima;
- (4) the requirements for OEI landing (see (b)) have been checked in the light of the latest reported weather conditions to ensure that they can be met; and
- (5) to the extent possible, having regard to information on current and forecast use of the offshore alternate helideck and on conditions prevailing, the availability of the offshore alternate helideck should be guaranteed by the duty holder (the rig operator in the case of fixed installations and the owner in the case of mobiles) until the landing at the destination, or the offshore alternate aerodrome, has been achieved or until offshore shuttling has been completed.

## (e) Offshore shuttling

Provided that the actions in (d) have been completed, offshore shuttling, using an offshore alternate aerodrome, may be carried out.

**AMC1 CAT.OP.MPA.182 Destination aerodromes — instrument approach operations**

## PBN OPERATIONS

The pilot-in-command should only select an aerodrome as a destination alternate aerodrome if an instrument approach procedure that does not rely on GNSS is available either at that aerodrome or at the destination aerodrome.

**GM1 CAT.OP.MPA.182 Destination aerodromes — instrument approach operations**

## INTENT OF AMC1

- (a) The limitation applies only to destination alternate aerodromes for flights when a destination alternate aerodrome is required. A take-off or en route alternate aerodrome with instrument approach procedures relying on GNSS may be planned without restrictions. A destination aerodrome with all instrument approach procedures relying solely on GNSS may be used without a destination alternate aerodrome if the conditions for a flight without a destination alternate aerodrome are met.
- (b) The term 'available' means that the procedure can be used in the planning stage and complies with planning minima requirements

### **GM1 CAT.OP.MPA.185 Planning minima for IFR flights — aeroplanes**

#### PLANNING MINIMA FOR ALTERNATE AERODROMES

Non-precision minima (NPA) in Table 1 of CAT.OP.MPA.185 mean the next highest minima that apply in the prevailing wind and serviceability conditions. Localiser only approaches, if published, are considered to be non-precision in this context. It is recommended that operators wishing to publish tables of planning minima choose values that are likely to be appropriate on the majority of occasions (e.g. regardless of wind direction). Unserviceabilities should, however, be fully taken into account.

As Table 1 does not include planning minima requirements for APV, lower than standard (LTS) CAT I and other than standard (OTS) CAT II operations, the operator may use the following minima:

- (a) for APV operations — NPA or CAT I minima, depending on the DH/MDH;
- (b) for LTS CAT I operations — CAT I minima; and
- (c) for OTS CAT II operations — CAT II minima.

## GM2 CAT.OP.MPA.185 Planning minima for IFR flights — aeroplanes

### AERODROME WEATHER FORECASTS

APPLICATION OF AERODROME FORECASTS (TAF & TREND) TO PRE-FLIGHT PLANNING (ICAO Annex 3 refers)							
<b>1. APPLICATION OF INITIAL PART OF TAF</b> a) <b>Application time period:</b> From the start of the TAF validity period up to the time of applicability of the first subsequent 'FM...*' or 'BECMG', or if no 'FM' or 'BECMG' is given, up to the end of the validity period of the TAF. b) <b>Application of forecast:</b> The prevailing weather conditions forecast in the initial part of the TAF should be fully applied with the exception of the mean wind and gusts (and crosswind) which should be applied in accordance with the policy in the column 'BECMGAT and FM' in the table below. This may however be overdue temporarily by a 'TEMPO' or 'PROB**' if applicable according to the table below.							
2. APPLICATION OF FORECAST FOLLOWING CHANGE INDICATION IN TAF AND TREND							
TAF or TREND for AERODROME PLANNED AS:	FM (alone) and BECMGAT:  Deterioration and Improvement	BECMG (alone), BECMG FM, BECMG TL, BECMG FM...*TL, in case of :		TEMPO (alone), TEMPO FM, TEMPO FM...TL, PROB30/40(alone)		PROB TEMPO  Improvement In any case  Deterioration and Improvement	
		Deterioration	Improvement	Deterioration Transient/Shower Conditions in connection with short – lived weather phenomena, e.g. thunderstorms, showers	Persistent Conditions in connection with e.g. haze, mist, fog, dust/sandstorm, continuous precipitations		
DESTINATION at ETA ± 1 HR TIME – OFF/ALTERNATE at ETA ± 1 HR DEST. ALTERNATE at ETA ± 1 HR EN-ROUTE ALTERNATE at ETA ± 1 HR	Applicable from the start of the change;  Mean wind: Should be within required limits;  Gusts: May be disregarded.	Applicable from the time of the start of the change;  Mean wind: Should be within required limits;  Gusts: May be disregarded.	Applicable from the time of the end of the change;  Mean wind: Should be within required limits;  Gusts: May be disregarded.	Not applicable  Mean wind and gusts exceeding required limits may be disregarded.	Applicable  Mean wind: Should be within required limits;  Gusts: May be disregarded;	Should be disregarded.	Deterioration may be disregarded; Improvement should be disregarded including mean wind and gusts.
ETOPS ENRT ALTN at earliest/latest ETA ± 1 HR	Applicable from the time of start of change;  Mean wind: should be within required limits; Gusts exceeding crosswind limits should be fully applied.	Applicable from the time of start of change;  Mean wind: should be within required limits; Gusts exceeding crosswind limits should be fully applied.	Applicable from the time of end of change;  Mean wind: should be within required limits; Gusts exceeding crosswind limits should be fully applied.	Applicable if below applicable landing minima;  Mean wind: Should be within required limits;  Gusts exceeding crosswind limits should be fully applied.	Applicable if below applicable landing minima;  Mean wind: Should be within required limits;  Gusts exceeding crosswind limits should be fully applied.		
Note 1: 'Required limits' are those contained in the Operations Manual. Note 2: If promulgated aerodrome forecasts do not comply with the requirements of ICAO Annex 3, operators should ensure that guidance in the application of these reports is provided. * The space following 'FM' should always include a time group e.g. 'FM1030'.							



**GM1 CAT.OP.MPA.186 Planning minima for IFR flights — helicopters**

## PLANNING MINIMA FOR ALTERNATE AERODROMES

Non-precision minima (NPA) in Table 1 of CAT.OP.MPA.186 mean the next highest minima that apply in the prevailing wind and serviceability conditions. Localiser only approaches, if published, are considered to be non-precision in this context. It is recommended that operators wishing to publish tables of planning minima choose values that are likely to be appropriate on the majority of occasions (e.g. regardless of wind direction). Unserviceabilities should, however, be fully taken into account.

As Table 1 does not include planning minima requirements for APV, LTS CAT I and OTS CAT II operations, the operator may use the following minima:

- (a) for APV operations — NPA or CAT I minima, depending on the DH/MDH;
- (b) for LTS CAT I operations — CAT I minima; and
- (c) for OTS CAT II operations — CAT II minima.

**AMC1 CAT.OP.MPA.190 Submission of the ATS flight plan**

## FLIGHTS WITHOUT ATS FLIGHT PLAN

- (a) When unable to submit or to close the ATS flight plan due to lack of ATS facilities or any other means of communications to ATS, the operator should establish procedures, instructions and a list of nominated persons to be responsible for alerting search and rescue services.
- (b) To ensure that each flight is located at all times, these instructions should:
  - (1) provide the nominated person with at least the information required to be included in a VFR flight plan, and the location, date and estimated time for re-establishing communications;
  - (2) if an aircraft is overdue or missing, provide for notification to the appropriate ATS or search and rescue facility; and
  - (3) provide that the information will be retained at a designated place until the completion of the flight.

**AMC1 CAT.OP.MPA.195 Refuelling/defuelling with passengers embarking, on board or disembarking**

## OPERATIONAL PROCEDURES — GENERAL

- (a) When refuelling/defuelling with passengers on board, ground servicing activities and work inside the aircraft, such as catering and cleaning, should be conducted in such a manner that they do not create a hazard and allow emergency evacuation to take place through those aisles and exits intended for emergency evacuation.
- (b) The deployment of integral aircraft stairs or the opening of emergency exits as a prerequisite to refuelling is not necessarily required.

## OPERATIONAL PROCEDURES — AEROPLANES

- (c) Operational procedures should specify that at least the following precautions are taken:
  - (1) one qualified person should remain at a specified location during fuelling operations with passengers on board. This qualified person should be capable of handling emergency procedures concerning fire protection and firefighting, handling communications, and initiating and directing an evacuation;

- (2) two-way communication should be established and should remain available by the aeroplane's inter-communication system or other suitable means between the ground crew supervising the refuelling and the qualified personnel on board the aeroplane; the involved personnel should remain within easy reach of the system of communication;
- (3) crew, personnel and passengers should be warned that re/defuelling will take place;
- (4) 'Fasten Seat Belts' signs should be off;
- (5) 'NO SMOKING' signs should be on, together with interior lighting to enable emergency exits to be identified;
- (6) passengers should be instructed to unfasten their seat belts and refrain from smoking;
- (7) the minimum required number of cabin crew should be on board and be prepared for an immediate emergency evacuation;
- (8) if the presence of fuel vapour is detected inside the aeroplane, or any other hazard arises during re/defuelling, fuelling should be stopped immediately;
- (9) the ground area beneath the exits intended for emergency evacuation and slide deployment areas should be kept clear at doors where stairs are not in position for use in the event of evacuation; and
- (10) provision is made for a safe and rapid evacuation.

#### OPERATIONAL PROCEDURES — HELICOPTERS

- (d) Operational procedures should specify that at least the following precautions are taken:
- (1) door(s) on the refuelling side of the helicopter remain closed;
  - (2) door(s) on the non-refuelling side of the helicopter remain open, weather permitting;
  - (3) firefighting facilities of the appropriate scale be positioned so as to be immediately available in the event of a fire;
  - (4) sufficient personnel be immediately available to move passengers clear of the helicopter in the event of a fire;
  - (5) sufficient qualified personnel be on board and be prepared for an immediate emergency evacuation;
  - (6) if the presence of fuel vapour is detected inside the helicopter, or any other hazard arises during refuelling/defuelling, fuelling be stopped immediately;
  - (7) the ground area beneath the exits intended for emergency evacuation be kept clear; and
  - (8) provision is made for a safe and rapid evacuation.

### **GM1 CAT.OP.MPA.200 Refuelling/defuelling with wide-cut fuel**

#### PROCEDURES

- (a) 'Wide-cut fuel' (designated JET B, JP-4 or AVTAG) is an aviation turbine fuel that falls between gasoline and kerosene in the distillation range and consequently, compared to kerosene (JET A or JET A1), it has the properties of higher volatility (vapour pressure), lower flash point and lower freezing point.

- (b) Wherever possible, the operator should avoid the use of wide-cut fuel types. If a situation arises such that only wide-cut fuels are available for refuelling/defuelling, operators should be aware that mixtures of wide-cut fuels and kerosene turbine fuels can result in the air/fuel mixture in the tank being in the combustible range at ambient temperatures. The extra precautions set out below are advisable to avoid arcing in the tank due to electrostatic discharge. The risk of this type of arcing can be minimised by the use of a static dissipation additive in the fuel. When this additive is present in the proportions stated in the fuel specification, the normal fuelling precautions set out below are considered adequate.
- (c) Wide-cut fuel is considered to be 'involved' when it is being supplied or when it is already present in aircraft fuel tanks.
- (d) When wide-cut fuel has been used, this should be recorded in the technical log. The next two uplifts of fuel should be treated as though they too involved the use of wide-cut fuel.
- (e) When refuelling/defuelling with turbine fuels not containing a static dissipator, and where wide-cut fuels are involved, a substantial reduction on fuelling flow rate is advisable. Reduced flow rate, as recommended by fuel suppliers and/or aeroplane manufacturers, has the following benefits:
  - (1) it allows more time for any static charge build-up in the fuelling equipment to dissipate before the fuel enters the tank;
  - (2) it reduces any charge which may build up due to splashing; and
  - (3) until the fuel inlet point is immersed, it reduces misting in the tank and consequently the extension of the flammable range of the fuel.
- (f) The flow rate reduction necessary is dependent upon the fuelling equipment in use and the type of filtration employed on the aeroplane fuelling distribution system. It is difficult, therefore, to quote precise flow rates. Reduction in flow rate is advisable whether pressure fuelling or over-wing fuelling is employed.
- (g) With over-wing fuelling, splashing should be avoided by making sure that the delivery nozzle extends as far as practicable into the tank. Caution should be exercised to avoid damaging bag tanks with the nozzle.

### **AMC1 CAT.OP.MPA.205 Push back and towing — aeroplanes**

#### **BARLESS TOWING**

- (a) Barless towing should be based on the applicable SAE ARP (Aerospace Recommended Practices), i.e. 4852B/4853B/5283/5284/5285 (as amended).
- (b) Pre- or post-taxi positioning of the aeroplanes should only be executed by barless towing if one of the following conditions are met:
  - (1) an aeroplane is protected by its own design from damage to the nose wheel steering system;
  - (2) a system/procedure is provided to alert the flight crew that damage referred to in (b)(1) may have or has occurred;
  - (3) the towing vehicle is designed to prevent damage to the aeroplane type; or
  - (4) the aeroplane manufacturer has published procedures and these are included in the operations manual.

### **AMC1 CAT.OP.MPA.210(b) Crew members at stations**

#### **CABIN CREW SEATING POSITIONS**

- (a) When determining cabin crew seating positions, the operator should ensure that they are:
  - (1) close to a floor level door/exit;

- (2) provided with a good view of the area(s) of the passenger cabin for which the cabin crew member is responsible; and
  - (3) evenly distributed throughout the cabin, in the above order of priority.
- (b) Item (a) should not be taken as implying that, in the event of there being more cabin crew stations than required cabin crew, the number of cabin crew members should be increased.

### **GM1 CAT.OP.MPA.210 Crew members at stations**

#### **MITIGATING MEASURES — CONTROLLED REST**

- (a) This GM addresses controlled rest taken by the minimum certified flight crew. It is not related to planned in-flight rest by members of an augmented crew.
- (b) Although flight crew members should stay alert at all times during flight, unexpected fatigue can occur as a result of sleep disturbance and circadian disruption. To cover for this unexpected fatigue, and to regain a high level of alertness, a controlled rest procedure in the flight crew compartment, organised by the commander may be used, if workload permits and a controlled rest procedure is described in the operations manual. 'Controlled rest' means a period of time 'off task' that may include actual sleep. The use of controlled rest has been shown to significantly increase the levels of alertness during the later phases of flight, particularly after the top of descent, and is considered to be good use of crew resource management (CRM) principles. Controlled rest should be used in conjunction with other on-board fatigue management countermeasures such as physical exercise, bright cockpit illumination at appropriate times, balanced eating and drinking, and intellectual activity.
- (c) Controlled rest taken in this way should not be considered to be part of a rest period for the purposes of calculating flight time limitations, nor used to justify any duty period. Controlled rest may be used to manage both sudden unexpected fatigue and fatigue that is expected to become more severe during higher workload periods later in the flight. Controlled rest is not related to fatigue management, which is planned before flight.
- (d) Controlled rest periods should be agreed according to individual needs and the accepted principles of CRM; where the involvement of the cabin crew is required, consideration should be given to their workload.
- (e) When applying controlled rest procedures, the commander should ensure that:
  - (1) the other flight crew member(s) is (are) adequately briefed to carry out the duties of the resting flight crew member;
  - (2) one flight crew member is fully able to exercise control of the aircraft at all times; and
  - (3) any system intervention that would normally require a cross-check according to multi-crew principles is avoided until the resting flight crew member resumes his/her duties.
- (f) Controlled rest procedures should satisfy all of the following criteria:
  - (1) Only one flight crew member at a time should take rest at his/her station; the restraint device should be used and the seat positioned to minimise unintentional interference with the controls.
  - (2) The rest period should be no longer than 45 minutes (in order to limit any actual sleep to approximately 30 minutes) to limit deep sleep and associated long recovery time (sleep inertia).

- (3) After this 45- minute period, there should be a recovery period of 20 minutes to overcome sleep inertia during which control of the aircraft should not be entrusted to the flight crew member. At the end of this recovery period, an appropriate briefing should be given.
- (4) In the case of two-crew operations, means should be established to ensure that the non-resting flight crew member remains alert. This may include:
  - (i) Appropriate alarm systems;
  - (ii) on-board systems to monitor flight crew activity; and
  - (iii) frequent cabin crew checks. In this case, the commander should inform the senior cabin crew member of the intention of the flight crew member to take controlled rest, and of the time of the end of that rest; frequent contact should be established between the non- resting flight crew member and the cabin crew by communication means, and the cabin crew should check that the resting flight crew member is awake at the end of the period.
- (5) There should be a minimum of 20 minutes between two subsequent controlled rest periods in order to overcome the effects of sleep inertia and allow for adequate briefing.
- (6) If necessary, a flight crew member may take more than one rest period, if time permits, on longer sectors, subject to the restrictions above.
- (7) Controlled rest periods should terminate at least 30 minutes before the top of descent.

### **GM1 CAT.OP.MPA.250 Ice and other contaminants — ground procedures**

#### TERMINOLOGY

Terms used in the context of de- icing/anti- icing have the meaning defined in the following subparagraphs.

- (a) 'Anti- icing fluid' includes, but is not limited to, the following:
  - (1) Type I fluid if heated to minimum 60°C at the nozzle;
  - (2) mixture of water and Type I fluid if heated to minimum 60°C at the nozzle;
  - (3) Type II fluid;
  - (4) mixture of water and Type II fluid;
  - (5) Type III fluid;
  - (6) mixture of water and Type III fluid;
  - (7) Type IV fluid;
  - (8) mixture of water and Type IV fluid.

On uncontaminated aircraft surfaces, Type II, III and IV anti-icing fluids are normally applied unheated.

- (b) 'Clear ice': a coating of ice, generally clear and smooth, but with some air pockets. It forms on exposed objects, the temperatures of which are at, below or slightly above the freezing temperature, by the freezing of super-cooled drizzle, droplets or raindrops.
- (c) Conditions conducive to aircraft icing on the ground (e.g. freezing fog, freezing precipitation, frost, rain or high humidity (on cold soaked wings), snow or mixed rain and snow).
- (d) 'Contamination', in this context, is understood as being all forms of frozen or semi-frozen moisture, such as frost, snow, slush or ice.
- (e) 'Contamination check': a check of aircraft for contamination to establish the need for de- icing.

- (f) 'De-icing fluid': such fluid includes, but is not limited to, the following:
- (1) heated water;
  - (2) Type I fluid;
  - (3) mixture of water and Type I fluid;
  - (4) Type II fluid;
  - (5) mixture of water and Type II fluid;
  - (6) Type III fluid;
  - (7) mixture of water and Type III fluid;
  - (8) Type IV fluid;
  - (9) mixture of water and Type IV fluid.

De-icing fluid is normally applied heated to ensure maximum efficiency.

- (g) 'De-icing/anti-icing': this is the combination of de-icing and anti-icing performed in either one or two steps.
- (h) 'Ground ice detection system (GIDS)': system used during aircraft ground operations to inform the personnel involved in the operation and/or the flight crew about the presence of frost, ice, snow or slush on the aircraft surfaces.
- (i) 'Lowest operational use temperature (LOUT)': the lowest temperature at which a fluid has been tested and certified as acceptable in accordance with the appropriate aerodynamic acceptance test whilst still maintaining a freezing point buffer of not less than:
- (1) 10°C for a Type I de-icing/anti-icing fluid; or
  - (2) 7°C for Type II, III or IV de-icing/anti-icing fluids.
- (j) 'Post-treatment check': an external check of the aircraft after de-icing and/or anti-icing treatment accomplished from suitably elevated observation points (e.g. from the de-icing/anti-icing equipment itself or other elevated equipment) to ensure that the aircraft is free from any frost, ice, snow, or slush.
- (k) 'Pre-take-off check': an assessment normally performed by the flight crew, to validate the applied HoT.
- (l) 'Pre-take-off contamination check': a check of the treated surfaces for contamination, performed when the HoT has been exceeded or if any doubt exists regarding the continued effectiveness of the applied anti-icing treatment. It is normally accomplished externally, just before commencement of the take-off run.

#### ANTI-ICING CODES

- (m) The following are examples of anti-icing codes:
- (1) 'Type I' at (start time) — to be used if anti-icing treatment has been performed with a Type I fluid;
  - (2) 'Type II/100' at (start time) — to be used if anti-icing treatment has been performed with undiluted Type II fluid;
  - (3) 'Type II/75' at (start time) — to be used if anti-icing treatment has been performed with a mixture of 75 % Type II fluid and 25 % water;
  - (4) 'Type IV/50' at (start time) — to be used if anti-icing treatment has been performed with a mixture of 50 % Type IV fluid and 50 % water.
- (n) When a two-step de-icing/anti-icing operation has been carried out, the anti-icing code should be determined by the second step fluid. Fluid brand names may be included, if desired.

**GM2 CAT.OP.MPA.250 Ice and other contaminants — ground procedures****DE- ICING/ANTI- ICING — PROCEDURES**

- (a) De- icing and/or anti- icing procedures should take into account manufacturer's recommendations, including those that are type-specific and cover:
  - (1) contamination checks, including detection of clear ice and under-wing frost; limits on the thickness/area of contamination published in the AFM or other manufacturers' documentation should be followed;
  - (2) procedures to be followed if de- icing and/or anti- icing procedures are interrupted or unsuccessful;
  - (3) post-treatment checks;
  - (4) pre- take-off checks;
  - (5) pre- take-off contamination checks;
  - (6) the recording of any incidents relating to de-icing and/or anti-icing; and
  - (7) the responsibilities of all personnel involved in de- icing and/or anti-icing.
- (b) Operator's procedures should ensure the following:
  - (1) When aircraft surfaces are contaminated by ice, frost, slush or snow, they are de-iced prior to take-off according to the prevailing conditions. Removal of contaminants may be performed with mechanical tools, fluids (including hot water), infrared heat or forced air, taking account of aircraft type- specific provisions.
  - (2) Account is taken of the wing skin temperature versus outside air temperature (OAT), as this may affect:
    - (i) the need to carry out aircraft de-icing and/or anti-icing; and/or
    - (ii) the performance of the de-icing/anti-icing fluids.
  - (3) When freezing precipitation occurs or there is a risk of freezing precipitation occurring that would contaminate the surfaces at the time of take-off, aircraft surfaces should be anti- iced. If both de- icing and anti- icing are required, the procedure may be performed in a one- or two- step process, depending upon weather conditions, available equipment, available fluids and the desired hold- over time (HoT). One-step de- icing/anti- icing means that de-icing and anti- icing are carried out at the same time, using a mixture of de-icing/anti-icing fluid and water. Two-step de- icing/anti- icing means that de-icing and anti- icing are carried out in two separate steps. The aircraft is first de-iced using heated water only or a heated mixture of de- icing/anti- icing fluid and water. After completion of the de-icing operation, a layer of a mixture of de- icing/anti-icing fluid and water, or of de-icing/anti-icing fluid only, is sprayed over the aircraft surfaces. The second step will be taken before the first-step fluid freezes, typically within three minutes and, if necessary, area by area.
  - (4) When an aircraft is anti-iced and a longer HoT is needed/desired, the use of a less diluted Type II or Type IV fluid should be considered.
  - (5) All restrictions relative to OAT and fluid application (including, but not necessarily limited to, temperature and pressure) published by the fluid manufacturer and/or aircraft manufacturer, are followed, and procedures, limitations and recommendations to prevent the formation of fluid residues are followed.

- (6) During conditions conducive to aircraft icing on the ground or after de-icing and/or anti-icing, an aircraft is not dispatched for departure unless it has been given a contamination check or a post-treatment check by a trained and qualified person. This check should cover all treated surfaces of the aircraft and be performed from points offering sufficient accessibility to these parts. To ensure that there is no clear ice on suspect areas, it may be necessary to make a physical check (e.g. tactile).
  - (7) The required entry is made in the technical log.
  - (8) The commander continually monitors the environmental situation after the performed treatment. Prior to take-off, he/she performs a pre-take-off check, which is an assessment of whether the applied HoT is still appropriate. This pre-take-off check includes, but is not limited to, factors such as precipitation, wind and OAT.
  - (9) If any doubt exists as to whether a deposit may adversely affect the aircraft's performance and/or controllability characteristics, the commander should arrange for a pre-take-off contamination check to be performed in order to verify that the aircraft's surfaces are free of contamination. Special methods and/or equipment may be necessary to perform this check, especially at night time or in extremely adverse weather conditions. If this check cannot be performed just before take-off, re-treatment should be applied.
  - (10) When re-treatment is necessary, any residue of the previous treatment should be removed and a completely new de-icing/anti-icing treatment should be applied.
  - (11) When a ground ice detection system (GIDS) is used to perform an aircraft surfaces check prior to and/or after a treatment, the use of GIDS by suitably trained personnel should be part of the procedure.
- (c) Special operational considerations
- (1) When using thickened de-icing/anti-icing fluids, the operator should consider a two-step de-icing/anti-icing procedure, the first step preferably with hot water and/or un-thickened fluids.
  - (2) The use of de-icing/anti-icing fluids should be in accordance with the aircraft manufacturer's documentation. This is particularly important for thickened fluids to assure sufficient flow-off during take-off.
  - (3) The operator should comply with any type-specific operational provision(s), such as an aircraft mass decrease and/or a take-off speed increase associated with a fluid application.
  - (4) The operator should take into account any flight handling procedures (stick force, rotation speed and rate, take-off speed, aircraft attitude etc.) laid down by the aircraft manufacturer when associated with a fluid application.
  - (5) The limitations or handling procedures resulting from (c)(3) and/or (c)(4) above should be part of the flight crew pre take-off briefing.
- (d) Communications
- (1) Before aircraft treatment. When the aircraft is to be treated with the flight crew on board, the flight and personnel involved in the operation should confirm the fluid to be used, the extent of treatment required and any aircraft type-specific procedure(s) to be used. Any other information needed to apply the HoT tables should be exchanged.
  - (2) Anti-icing code. The operator's procedures should include an anti-icing code, which indicates the treatment the aircraft has received. This code provides the flight crew with the minimum details necessary to estimate a HoT and confirms that the aircraft is free of contamination.



- (3) After treatment. Before reconfiguring or moving the aircraft, the flight crew should receive a confirmation from the personnel involved in the operation that all de-icing and/or anti-icing operations are complete and that all personnel and equipment are clear of the aircraft.
- (e) Hold-over protection  
The operator should publish in the operations manual, when required, the HoTs in the form of a table or a diagram, to account for the various types of ground icing conditions and the different types and concentrations of fluids used. However, the times of protection shown in these tables are to be used as guidelines only and are normally used in conjunction with the pre-take-off check.
- (f) Training  
The operator's initial and recurrent de-icing and/or anti-icing training programmes (including communication training) for flight crew and those of its personnel involved in the operation who are involved in de-icing and/or anti-icing should include additional training if any of the following is introduced:
- (1) a new method, procedure and/or technique;
  - (2) a new type of fluid and/or equipment; or
  - (3) a new type of aircraft.
- (g) Contracting  
When the operator contracts training on de-icing/anti-icing, the operator should ensure that the contractor complies with the operator's training/qualification procedures, together with any specific procedures in respect of:
- (1) de-icing and/or anti-icing methods and procedures;
  - (2) fluids to be used, including precautions for storage and preparation for use;
  - (3) specific aircraft provisions (e.g. no-spray areas, propeller/engine de-icing,
  - (4) APU operation etc.); and
  - (5) checking and communications procedures.
- (h) Special maintenance considerations
- (1) General  
The operator should take proper account of the possible side-effects of fluid use. Such effects may include, but are not necessarily limited to, dried and/or re-hydrated residues, corrosion and the removal of lubricants.
  - (2) Special considerations regarding residues of dried fluids  
The operator should establish procedures to prevent or detect and remove residues of dried fluid. If necessary the operator should establish appropriate inspection intervals based on the recommendations of the airframe manufacturers and/or the operator's own experience:
    - (i) Dried fluid residues  
Dried fluid residues could occur when surfaces have been treated and the aircraft has not subsequently been flown and has not been subject to precipitation. The fluid may then have dried on the surfaces.
    - (ii) Re-hydrated fluid residues  
Repetitive application of thickened de-icing/anti-icing fluids may lead to the subsequent formation/build-up of a dried residue in aerodynamically quiet areas, such as cavities and gaps. This residue may re-hydrate if exposed to high humidity conditions, precipitation, washing, etc., and increase to many times its original size/volume. This residue will freeze if exposed to conditions at or below 0 °C. This may cause moving parts, such as elevators, ailerons, and flap actuating mechanisms to stiffen or

jam in-flight. Re-hydrated residues may also form on exterior surfaces, which can reduce lift, increase drag and stall speed. Re-hydrated residues may also collect inside control surface structures and cause clogging of drain holes or imbalances to flight controls. Residues may also collect in hidden areas, such as around flight control hinges, pulleys, grommets, on cables and in gaps.

- (iii) Operators are strongly recommended to obtain information about the fluid dry- out and re- hydration characteristics from the fluid manufacturers and to select products with optimised characteristics.
- (iv) Additional information should be obtained from fluid manufacturers for handling, storage, application and testing of their products.

### **GM3 CAT.OP.MPA.250 Ice and other contaminants — ground procedures**

#### **DE-ICING/ANTI-ICING BACKGROUND INFORMATION**

Further guidance material on this issue is given in the ICAO Manual of Aircraft Ground De-icing/Anti-icing Operations (Doc 9640) (hereinafter referred to as the ICAO Manual of Aircraft Ground De-icing/Anti-icing Operations).

#### (a) General

- (1) Any deposit of frost, ice, snow or slush on the external surfaces of an aircraft may drastically affect its flying qualities because of reduced aerodynamic lift, increased drag, modified stability and control characteristics. Furthermore, freezing deposits may cause moving parts, such as elevators, ailerons, flap actuating mechanism etc., to jam and create a potentially hazardous condition. Propeller/engine/auxiliary power unit (APU)/systems performance may deteriorate due to the presence of frozen contaminants on blades, intakes and components. Also, engine operation may be seriously affected by the ingestion of snow or ice, thereby causing engine stall or compressor damage. In addition, ice/frost may form on certain external surfaces (e.g. wing upper and lower surfaces, etc.) due to the effects of cold fuel/structures, even in ambient temperatures well above 0 °C.
- (2) Procedures established by the operator for de-icing and/or anti-icing are intended to ensure that the aircraft is clear of contamination so that degradation of aerodynamic characteristics or mechanical interference will not occur and, following anti-icing, to maintain the airframe in that condition during the appropriate HoT.
- (3) Under certain meteorological conditions, de-icing and/or anti-icing procedures may be ineffective in providing sufficient protection for continued operations. Examples of these conditions are freezing rain, ice pellets and hail, heavy snow, high wind velocity, fast dropping OAT or any time when freezing precipitation with high water content is present. No HoT guidelines exist for these conditions.
- (4) Material for establishing operational procedures can be found, for example, in:
  - (i) ICAO Annex 3, Meteorological Service for International Air Navigation;
  - (ii) ICAO Manual of Aircraft Ground De-icing/Anti-icing Operations;
  - (iii) ISO 11075 Aircraft - De-icing/anti-icing fluids - ISO type I;
  - (iv) ISO 11076 Aircraft - De-icing/anti-icing methods with fluids;
  - (v) ISO 11077 Aerospace - Self propelled de-icing/anti-icing vehicles - Functional requirements;
  - (vi) ISO 11078 Aircraft - De-icing/anti-icing fluids -- ISO types II, III and IV;

- (vii) AEA 'Recommendations for de-icing/anti-icing of aircraft on the ground';
- (viii) AEA 'Training recommendations and background information for de-icing/anti-icing of aircraft on the ground';
- (ix) EUROCAE ED-104A Minimum Operational Performance Specification for Ground Ice Detection Systems;
- (x) SAE AS5681 Minimum Operational Performance Specification for Remote On- Ground Ice Detection Systems;
- (xi) SAE ARP4737 Aircraft - De-icing/anti-icing methods;
- (xii) SAE AMS1424 De-icing/anti-Icing Fluid, Aircraft, SAE Type I;
- (xiii) SAE AMS1428 Fluid, Aircraft De-icing/anti-Icing, Non-Newtonian, (Pseudoplastic), SAE Types II, III, and IV;
- (xiv) SAE ARP1971 Aircraft De-icing Vehicle - Self-Propelled, Large and Small Capacity;
- (xv) SAE ARP5149 Training Programme Guidelines for De-icing/anti-icing of Aircraft on Ground; and
- (xvi) SAE ARP5646 Quality Program Guidelines for De-icing/anti-icing of Aircraft on the Ground.

(b) Fluids

- (1) Type I fluid: Due to its properties, Type I fluid forms a thin, liquid-wetting film on surfaces to which it is applied which, under certain weather conditions, gives a very limited HoT. With this type of fluid, increasing the concentration of fluid in the fluid/water mix does not provide any extension in HoT.
- (2) Type II and Type IV fluids contain thickeners which enable the fluid to form a thicker liquid-wetting film on surfaces to which it is applied. Generally, this fluid provides a longer HoT than Type I fluids in similar conditions. With this type of fluid, the HoT can be extended by increasing the ratio of fluid in the fluid/water mix.
- (3) Type III fluid is a thickened fluid especially intended for use on aircraft with low rotation speeds.
- (4) Fluids used for de-icing and/or anti-icing should be acceptable to the operator and the aircraft manufacturer. These fluids normally conform to specifications such as SAE AMS1424, SAE AMS1428 or equivalent. Use of non-conforming fluids is not recommended due to their characteristics being unknown. The anti-icing and aerodynamic properties of thickened fluids may be seriously degraded by, for example, inappropriate storage, treatment, application, application equipment and age.

(c) Hold-over protection

- (1) Hold-over protection is achieved by a layer of anti-icing fluid remaining on and protecting aircraft surfaces for a period of time. With an one-step de-icing/anti-icing procedure, the HoT begins at the commencement of de-icing/anti-icing. With a two-step procedure, the HoT begins at the commencement of the second (anti-icing) step. The hold-over protection runs out:
  - (i) at the commencement of the take-off roll (due to aerodynamic shedding of fluid); or
  - (ii) when frozen deposits start to form or accumulate on treated aircraft surfaces, thereby indicating the loss of effectiveness of the fluid.

- (2) The duration of hold-over protection may vary depending on the influence of factors other than those specified in the HoT tables. Guidance should be provided by the operator to take account of such factors, which may include:
  - (i) atmospheric conditions, e.g. exact type and rate of precipitation, wind direction and velocity, relative humidity and solar radiation; and
  - (ii) the aircraft and its surroundings, such as aircraft component inclination angle, contour and surface roughness, surface temperature, operation in close proximity to other aircraft (jet or propeller blast) and ground equipment and structures.
- (3) HoTs are not meant to imply that flight is safe in the prevailing conditions if the specified HoT has not been exceeded. Certain meteorological conditions, such as freezing drizzle or freezing rain, may be beyond the certification envelope of the aircraft.
- (4) References to usable HoT tables may be found in the AEA 'Recommendations for de-icing/anti-icing of aircraft on the ground'.

### **AMC1 CAT.OP.MPA.255 Ice and other contaminants — flight procedures**

#### **FLIGHT IN EXPECTED OR ACTUAL ICING CONDITIONS — AEROPLANES**

- (a) In case of flight into known or expected icing conditions, the aircraft must be certified, equipped and/or treated to operate safely in such conditions. The procedures to be established by the operator should take account of the design, the equipment, the configuration of the aircraft and the necessary training. For these reasons, different aircraft types operated by the same company may require the development of different procedures. In every case, the relevant limitations are those which are defined in the AFM and other documents produced by the manufacturer.
- (b) The operator should ensure that the procedures take account of the following:
  - (1) the equipment and instruments which must be serviceable for flight in icing conditions;
  - (2) the limitations on flight in icing conditions for each phase of flight. These limitations may be imposed by the aircraft's de-icing or anti-icing equipment or the necessary performance corrections that have to be made;
  - (3) the criteria the flight crew should use to assess the effect of icing on the performance and/or controllability of the aircraft;
  - (4) the means by which the flight crew detects, by visual cues or the use of the aircraft's ice detection system, that the flight is entering icing conditions; and
  - (5) the action to be taken by the flight crew in a deteriorating situation (which may develop rapidly) resulting in an adverse effect on the performance and/or controllability of the aircraft, due to:
    - (i) the failure of the aircraft's anti-icing or de-icing equipment to control a build-up of ice; and/or
    - (ii) ice build-up on unprotected areas.
- (c) Training for dispatch and flight in expected or actual icing conditions. The content of the operations manual should reflect the training, both conversion and recurrent, which flight crew, cabin crew and all other relevant operational personnel require in order to comply with the procedures for dispatch and flight in icing conditions:
  - (1) For the flight crew, the training should include:
    - (i) instruction on how to recognise, from weather reports or forecasts which are available before flight commences or during flight, the risks of encountering icing conditions along the planned route and on how to modify, as necessary, the departure and in-flight routes or profiles;

- (ii) instruction on the operational and performance limitations or margins;
  - (iii) the use of in-flight ice detection, anti-icing and de-icing systems in both normal and abnormal operation; and
  - (iv) instruction on the differing intensities and forms of ice accretion and the consequent action which should be taken.
- (2) For the cabin crew, the training should include:
- (i) awareness of the conditions likely to produce surface contamination; and
  - (ii) the need to inform the flight crew of significant ice accretion.

## **AMC2 CAT.OP.MPA.255 Ice and other contaminants — flight procedures**

### **FLIGHT IN EXPECTED OR ACTUAL ICING CONDITIONS — HELICOPTERS**

- (a) The procedures to be established by the operator should take account of the design, the equipment and the configuration of the helicopter and also of the training which is needed. For these reasons, different helicopter types operated by the same company may require the development of different procedures. In every case, the relevant limitations are those that are defined in the AFM and other documents produced by the manufacturer.
- (b) For the required entries in the operations manual, the procedural principles that apply to flight in icing conditions are referred to under Subpart MLR of Part ORO (ORO.MLR) and should be cross-referenced, where necessary, to supplementary, type-specific data.
- (c) Technical content of the procedures
 

The operator should ensure that the procedures take account of the following:

  - (1) CAT.IDE.H.165;
  - (2) the equipment and instruments that should be serviceable for flight in icing conditions;
  - (3) the limitations on flight in icing conditions for each phase of flight. These limitations may be specified by the helicopter's de-icing or anti-icing equipment or the necessary performance corrections which have to be made;
  - (4) the criteria the flight crew should use to assess the effect of icing on the performance and/or controllability of the helicopter;
  - (5) the means by which the flight crew detects, by visual cues or the use of the helicopter's ice detection system, that the flight is entering icing conditions; and
  - (6) the action to be taken by the flight crew in a deteriorating situation (which may develop rapidly) resulting in an adverse effect on the performance and/or controllability of the helicopter, due to either:
    - (i) the failure of the helicopter's anti-icing or de-icing equipment to control a build-up of ice; and/or
    - (ii) ice build-up on unprotected areas.
- (d) Training for dispatch and flight in expected or actual icing conditions
 

The content of the operations manual, Part D, should reflect the training, both conversion and recurrent, which flight crew, and all other relevant operational personnel will require in order to comply with the procedures for dispatch and flight in icing conditions.

  - (1) For the flight crew, the training should include:

- (i) instruction on how to recognise, from weather reports or forecasts that are available before flight commences or during flight, the risks of encountering icing conditions along the planned route and on how to modify, as necessary, the departure and in-flight routes or profiles;
  - (ii) instruction on the operational and performance limitations or margins;
  - (iii) the use of in-flight ice detection, anti-icing and de-icing systems in both normal and abnormal operation; and
  - (iv) instruction on the differing intensities and forms of ice accretion and the consequent action which should be taken.
- (2) For crew members other than flight crew, the training should include;
- (i) awareness of the conditions likely to produce surface contamination; and
  - (ii) the need to inform the flight crew of significant ice accretion.

### **AMC1 CAT.OP.MPA.281 In-flight fuel management — helicopters**

#### **COMPLEX MOTOR-POWERED HELICOPTERS, OTHER THAN LOCAL OPERATIONS**

The operator should base in-flight fuel management procedures on the following criteria:

- (a) In-flight fuel checks
  - (1) The commander should ensure that fuel checks are carried out in-flight at regular intervals. The remaining fuel should be recorded and evaluated to:
    - (i) compare actual consumption with planned consumption;
    - (ii) check that the remaining fuel is sufficient to complete the flight; and
    - (iii) determine the expected fuel remaining on arrival at the destination.
  - (2) The relevant fuel data should be recorded.
- (b) In-flight fuel management
  - (1) If, as a result of an in-flight fuel check, the expected fuel remaining on arrival at the destination is less than the required alternate fuel plus final reserve fuel, the commander should:
    - (i) divert; or
    - (ii) replan the flight in accordance with CAT.OP.MPA.181 (d)(1) unless he/she considers it safer to continue to the destination.
  - (2) At an onshore destination, when two suitable, separate touchdown and lift-off areas are available and the weather conditions at the destination comply with those specified for planning in CAT.OP.MPA.245 (a)(2), the commander may permit alternate fuel to be used before landing at the destination.
- (c) If, as a result of an in-flight fuel check on a flight to an isolated destination, planned in accordance with (b), the expected fuel remaining at the point of last possible diversion is less than the sum of:
  - (1) fuel to divert to an operating site selected in accordance with CAT.OP.MPA.181 (a)
  - (2) contingency fuel; and
  - (3) final reserve fuel,
 the commander should:
  - (i) divert; or
  - (ii) proceed to the destination provided that at onshore destinations, two suitable, separate touchdown and lift-off areas are available at the destination and the expected weather conditions at the destination comply with those specified for planning in CAT.OP.MPA.245 (a)(2).

**GM1 CAT.OP.MPA.290 Ground proximity detection****TERRAIN AWARENESS WARNING SYSTEM (TAWS) FLIGHT CREW TRAINING PROGRAMMES****(a) Introduction**

- (1) This GM contains performance-based training objectives for TAWS flight crew training.
- (2) The training objectives cover five areas: theory of operation; pre-flight operations; general in-flight operations; response to TAWS cautions; and response to TAWS warnings.
- (3) The term 'TAWS' in this GM means a ground proximity warning system (GPWS) enhanced by a forward-looking terrain avoidance function. Alerts include both cautions and warnings.
- (4) The content of this GM is intended to assist operators who are producing training programmes. The information it contains has not been tailored to any specific aircraft or TAWS equipment, but highlights features which are typically available where such systems are installed. It is the responsibility of the individual operator to determine the applicability of the content of this guidance material to each aircraft and TAWS equipment installed and their operation. Operators should refer to the AFM and/or aircraft/flight crew operating manual (A/FCOM), or similar documents, for information applicable to specific configurations. If there should be any conflict between the content of this guidance material and that published in the other documents described above, then information contained in the AFM or A/FCOM will take precedence.

**(b) Scope**

- (1) The scope of this GM is designed to identify training objectives in the areas of: academic training; manoeuvre training; initial evaluation; and recurrent qualification. Under each of these four areas, the training material has been separated into those items which are considered essential training items and those that are considered to be desirable. In each area, objectives and acceptable performance criteria are defined.
- (2) No attempt is made to define how the training programme should be implemented. Instead, objectives are established to define the knowledge that a pilot operating a TAWS is expected to possess and the performance expected from a pilot who has completed TAWS training. However, the guidelines do indicate those areas in which the pilot receiving the training should demonstrate his/her understanding, or performance, using a real-time, interactive training device, i.e. a flight simulator. Where appropriate, notes are included within the performance criteria which amplify or clarify the material addressed by the training objective.

**(c) Performance-based training objectives****(1) TAWS academic training**

- (i) This training is typically conducted in a classroom environment. The knowledge demonstrations specified in this section may be completed through the successful completion of written tests or by providing correct responses to non- real-time computer- based training (CBT) questions.

- (ii) Theory of operation. The pilot should demonstrate an understanding of TAWS operation and the criteria used for issuing cautions and warnings. This training should address system operation. Objective: To demonstrate knowledge of how a TAWS functions. Criteria: The pilot should demonstrate an understanding of the following functions:
- (A) Surveillance
- (a) The GPWS computer processes data supplied from an air data computer, a radio altimeter, an instrument landing system (ILS)/microwave landing system (MLS)/multi-mode (MM) receiver, a roll attitude sensor, and actual position of the surfaces and of the landing gear.
  - (b) The forward- looking terrain avoidance function utilises an accurate source of known aircraft position, such as that which may be provided by a flight management system (FMS) or GPS, or an electronic terrain database. The source and scope of the terrain, obstacle and airport data, and features such as the terrain clearance floor, the runway picker, and geometric altitude (where provided) should all be described.
  - (c) Displays required to deliver TAWS outputs include a loudspeaker for voice announcements, visual alerts (typically amber and red lights), and a terrain awareness display (that may be combined with other displays). In addition, means should be provided for indicating the status of the TAWS and any partial or total failures that may occur.
- (B) Terrain avoidance. Outputs from the TAWS computer provides visual and audio synthetic voice cautions and warnings to alert the flight crew about potential conflicts with terrain and obstacles.
- (C) Alert thresholds. Objective: To demonstrate knowledge of the criteria for issuing cautions and warnings. Criteria: The pilot should be able to demonstrate an understanding of the methodology used by a TAWS to issue cautions and alerts and the general criteria for the issuance of these alerts, including:
- (a) basic GPWS alerting modes specified in the ICAO Standard:
    - Mode 1: excessive sink rate;
    - Mode 2: excessive terrain closure rate;
    - Mode 3: descent after take-off or go-around;
    - Mode 4: unsafe proximity to terrain;
    - Mode 5: descent below ILS glide slope (caution only); and
  - (b) an additional, optional alert mode — Mode 6: radio altitude call-out (information only); TAWS cautions and warnings which alert the flight crew to obstacles and terrain ahead of the aircraft in line with or adjacent to its projected flight path (forward- looking terrain avoidance (FLTA) and premature descent alert (PDA) functions).
- (D) TAWS limitations. Objective: To verify that the pilot is aware of the limitations of TAWS. Criteria: The pilot should demonstrate knowledge and an understanding of TAWS limitations identified by the manufacturer for the equipment model installed, such as:
- (a) navigation should not be predicated on the use of the terrain display;



- (b) unless geometric altitude data are provided, use of predictive TAWS functions is prohibited when altimeter subscale settings display 'QFE';
  - (c) nuisance alerts can be issued if the aerodrome of intended landing is not included in the TAWS airport database;
  - (d) in cold weather operations, corrective procedures should be implemented by the pilot unless the TAWS has in- built compensation, such as geometric altitude data;
  - (e) loss of input data to the TAWS computer could result in partial or total loss of functionality. Where means exist to inform the flight crew that functionality has been degraded, this should be known and the consequences understood;
  - (f) radio signals not associated with the intended flight profile (e.g. ILS glide path transmissions from an adjacent runway) may cause false alerts;
  - (g) inaccurate or low accuracy aircraft position data could lead to false or non-annunciation of terrain or obstacles ahead of the aircraft; and
  - (h) minimum equipment list (MEL) restrictions should be applied in the event of the TAWS becoming partially or completely unserviceable. (It should be noted that basic GPWS has no forward- looking capability.)
- (E) TAWS inhibits. Objective: To verify that the pilot is aware of the conditions under which certain functions of a TAWS are inhibited. Criteria: The pilot should demonstrate knowledge and an understanding of the various TAWS inhibits, including the following means of:
- (a) silencing voice alerts;
  - (b) inhibiting ILS glide path signals (as may be required when executing an ILS back beam approach);
  - (c) inhibiting flap position sensors (as may be required when executing an approach with the flaps not in a normal position for landing);
  - (d) inhibiting the FLTA and PDA functions; and
  - (e) selecting or deselecting the display of terrain information, together with appropriate annunciation of the status of each selection.
- (2) Operating procedures. The pilot should demonstrate the knowledge required to operate TAWS avionics and to interpret the information presented by a TAWS. This training should address the following topics:
- (i) Use of controls. Objective: To verify that the pilot can properly operate all TAWS controls and inhibits. Criteria: The pilot should demonstrate the proper use of controls, including the following means by which:
    - (A) before flight, any equipment self- test functions can be initiated;
    - (B) TAWS information can be selected for display; and
    - (C) all TAWS inhibits can be operated and what the consequent annunciations mean with regard to loss of functionality.

- (ii) Display interpretation. Objective: To verify that the pilot understands the meaning of all information that can be annunciated or displayed by a TAWS. Criteria: The pilot should demonstrate the ability to properly interpret information annunciated or displayed by a TAWS, including the following:
  - (A) knowledge of all visual and aural indications that may be seen or heard;
  - (B) response required on receipt of a caution;
  - (C) response required on receipt of a warning; and
  - (D) response required on receipt of a notification that partial or total failure of the TAWS has occurred (including annunciation that the present aircraft position is of low accuracy).
- (iii) Use of basic GPWS or use of the FLTA function only. Objective: To verify that the pilot understands what functionality will remain following loss of the GPWS or of the FLTA function. Criteria: The pilot should demonstrate knowledge of how to recognise the following:
  - (A) un-commanded loss of the GPWS function, or how to isolate this function and how to recognise the level of the remaining controlled flight into terrain (CFIT) protection (essentially, this is the FLTA function); and
  - (B) un-commanded loss of the FLTA function, or how to isolate this function and how to recognise the level of the remaining CFIT protection (essentially, this is the basic GPWS).
- (iv) Crew coordination. Objective: To verify that the pilot adequately briefs other flight crew members on how TAWS alerts will be handled. Criteria: The pilot should demonstrate that the pre-flight briefing addresses procedures that will be used in preparation for responding to TAWS cautions and warnings, including the following:
  - (A) the action to be taken, and by whom, in the event that a TAWS caution and/or warning is issued; and
  - (B) how multi-function displays will be used to depict TAWS information at take-off, in the cruise and for the descent, approach, landing (and any go-around). This will be in accordance with procedures specified by the operator, who will recognise that it may be more desirable that other data are displayed at certain phases of flight and that the terrain display has an automatic 'pop- up' mode in the event that an alert is issued.
- (v) Reporting rules. Objective: To verify that the pilot is aware of the rules for reporting alerts to the controller and other authorities. Criteria: The pilot should demonstrate knowledge of the following:
  - (A) when, following recovery from a TAWS alert or caution, a transmission of information should be made to the appropriate ATC unit; and
  - (B) the type of written report that is required, how it is to be compiled, and whether any cross reference should be made in the aircraft technical log and/or voyage report (in accordance with procedures specified by the operator), following a flight in which the aircraft flight path has been modified in response to a TAWS alert, or if any part of the equipment appears not to have functioned correctly.

- (vi) Alert thresholds. Objective: To demonstrate knowledge of the criteria for issuing cautions and warnings. Criteria: The pilot should be able to demonstrate an understanding of the methodology used by a TAWS to issue cautions and warnings and the general criteria for the issuance of these alerts, including awareness of the following:
  - (A) modes associated with basic GPWS, including the input data associated with each; and
  - (B) visual and aural annunciations that can be issued by TAWS and how to identify which are cautions and which are warnings.
- (3) TAWS manoeuvre training. The pilot should demonstrate the knowledge required to respond correctly to TAWS cautions and warnings. This training should address the following topics:
  - (i) Response to cautions:
    - (A) Objective: To verify that the pilot properly interprets and responds to cautions. Criteria: The pilot should demonstrate an understanding of the need, without delay:
      - (a) to initiate action required to correct the condition which has caused the TAWS to issue the caution and to be prepared to respond to a warning, if this should follow; and
      - (b) if a warning does not follow the caution, to notify the controller of the new position, heading and/or altitude/flight level of the aircraft, and what the commander intends to do next.
    - (B) The correct response to a caution might require the pilot to:
      - (a) reduce a rate of descent and/or to initiate a climb;
      - (b) regain an ILS glide path from below, or to inhibit a glide path signal if an ILS is not being flown;
      - (c) select more flap, or to inhibit a flap sensor if the landing is being conducted with the intent that the normal flap setting will not be used;
      - (d) select gear down; and/or
      - (e) initiate a turn away from the terrain or obstacle ahead and towards an area free of such obstructions if a forward-looking terrain display indicates that this would be a good solution and the entire manoeuvre can be carried out in clear visual conditions.
  - (ii) Response to warnings. Objective: To verify that the pilot properly interprets and responds to warnings. Criteria: The pilot should demonstrate an understanding of the following:
    - (A) The need, without delay, to initiate a climb in the manner specified by the operator.
    - (B) The need, without delay, to maintain the climb until visual verification can be made that the aircraft will clear the terrain or obstacle ahead or until above the appropriate sector safe altitude (if certain about the location of the aircraft with respect to terrain) even if the TAWS warning stops. If, subsequently, the aircraft climbs up through the sector safe altitude, but the visibility does not allow the flight crew to confirm that the terrain hazard has ended, checks should be made to verify the location of the aircraft and to confirm that the altimeter subscale settings are correct.

- (C) When the workload permits that, the flight crew should notify the air traffic controller of the new position and altitude/flight level, and what the commander intends to do next.
  - (D) That the manner in which the climb is made should reflect the type of aircraft and the method specified by the aircraft manufacturer (which should be reflected in the operations manual) for performing the escape manoeuvre. Essential aspects will include the need for an increase in pitch attitude, selection of maximum thrust, confirmation that external sources of drag (e.g. spoilers/speed brakes) are retracted, and respect of the stick shaker or other indication of eroded stall margin.
  - (E) That TAWS warnings should never be ignored. However, the pilot's response may be limited to that which is appropriate for a caution, only if:
    - (a) the aircraft is being operated by day in clear, visual conditions; and
    - (b) it is immediately clear to the pilot that the aircraft is in no danger in respect of its configuration, proximity to terrain or current flight path.
- (4) TAWS initial evaluation:
- (i) The flight crew member's understanding of the academic training items should be assessed by means of a written test.
  - (ii) The flight crew member's understanding of the manoeuvre training items should be assessed in a FSTD equipped with TAWS visual and aural displays and inhibit selectors similar in appearance and operation to those in the aircraft which the pilot will fly. The results should be assessed by a synthetic flight instructor, synthetic flight examiner, type rating instructor or type rating examiner.
  - (iii) The range of scenarios should be designed to give confidence that proper and timely responses to TAWS cautions and warnings will result in the aircraft avoiding a CFIT accident. To achieve this objective, the pilot should demonstrate taking the correct action to prevent a caution developing into a warning and, separately, the escape manoeuvre needed in response to a warning. These demonstrations should take place when the external visibility is zero, though there is much to be learnt if, initially, the training is given in 'mountainous' or 'hilly' terrain with clear visibility. This training should comprise a sequence of scenarios, rather than be included in line oriented flight training (LOFT).
  - (iv) A record should be made, after the pilot has demonstrated competence, of the scenarios that were practised.
- (5) TAWS recurrent training:
- (i) TAWS recurrent training ensures that pilots maintain the appropriate TAWS knowledge and skills. In particular, it reminds pilots of the need to act promptly in response to cautions and warnings, and of the unusual attitude associated with flying the escape manoeuvre.
  - (ii) An essential item of recurrent training is the discussion of any significant issues and operational concerns that have been identified by the operator. Recurrent training should also address changes to TAWS logic, parameters or procedures and to any unique TAWS characteristics of which pilots should be aware.
- (6) Reporting procedures:

- (i) Verbal reports. Verbal reports should be made promptly to the appropriate air traffic control unit:
  - (A) whenever any manoeuvre has caused the aircraft to deviate from an air traffic clearance;
  - (B) when, following a manoeuvre which has caused the aircraft to deviate from an air traffic clearance, the aircraft has returned to a flight path which complies with the clearance; and/or
  - (C) when an air traffic control unit issues instructions which, if followed, would cause the pilot to manoeuvre the aircraft towards terrain or obstacle or it would appear from the display that a potential CFIT occurrence is likely to result.
- (ii) Written reports. Written reports should be submitted in accordance with the operator's occurrence reporting scheme and they also should be recorded in the aircraft technical log:
  - (A) whenever the aircraft flight path has been modified in response to a TAWS alert (false, nuisance or genuine);
  - (B) whenever a TAWS alert has been issued and is believed to have been false; and/or
  - (C) if it is believed that a TAWS alert should have been issued, but was not.
- (iii) Within this GM and with regard to reports:
  - (A) the term 'false' means that the TAWS issued an alert which could not possibly be justified by the position of the aircraft in respect to terrain and it is probable that a fault or failure in the system (equipment and/or input data) was the cause;
  - (B) the term 'nuisance' means that the TAWS issued an alert which was appropriate, but was not needed because the flight crew could determine by independent means that the flight path was, at that time, safe;
  - (C) the term 'genuine' means that the TAWS issued an alert which was both appropriate and necessary; and
  - (D) the report terms described in (c)(6)(iii) are only meant to be assessed after the occurrence is over, to facilitate subsequent analysis, the adequacy of the equipment and the programmes it contains. The intention is not for the flight crew to attempt to classify an alert into any of these three categories when visual and/or aural cautions or warnings are annunciated.

## **GM1 CAT.OP.MPA.295 Use of airborne collision avoidance system (ACAS)**

### GENERAL

- (a) The ACAS operational procedures and training programmes established by the operator should take into account this GM. It incorporates advice contained in:
  - (1) ICAO Annex 10, Volume IV;
  - (2) ICAO PANS- OPS, Volume 1;
  - (3) ICAO PANS-ATM; and
  - (4) ICAO guidance material 'ACAS Performance- Based Training Objectives' (published under Attachment E of State Letter AN 7/1.3.7.2-97/77).
- (b) Additional guidance material on ACAS may be referred to, including information available from such sources as EUROCONTROL.

### ACAS FLIGHT CREW TRAINING PROGRAMMES

- (c) During the implementation of ACAS, several operational issues were identified which had been attributed to deficiencies in flight crew training programmes. As a result, the issue of flight crew training has been discussed within the ICAO, which has developed guidelines for operators to use when designing training programmes.
- (d) This GM contains performance-based training objectives for ACAS II flight crew training. Information contained in this paper related to traffic advisories (TAs) is also applicable to ACAS I and ACAS II users. The training objectives cover five areas: theory of operation; pre-flight operations; general in-flight operations; response to TAs; and response to resolution advisories (RAs).
- (e) The information provided is valid for version 7 and 7.1 (ACAS II). Where differences arise, these are identified.
- (f) The performance-based training objectives are further divided into the areas of: academic training; manoeuvre training; initial evaluation and recurrent qualification. Under each of these four areas, the training material has been separated into those items which are considered essential training items and those which are considered desirable. In each area, objectives and acceptable performance criteria are defined.
- (g) ACAS academic training
  - (1) This training is typically conducted in a classroom environment. The knowledge demonstrations specified in this section may be completed through the successful completion of written tests or through providing correct responses to non-real-time computer-based training (CBT) questions.
  - (2) Essential items
    - (i) Theory of operation. The flight crew member should demonstrate an understanding of ACAS II operation and the criteria used for issuing TAs and RAs. This training should address the following topics:
      - (A) System operation
        - Objective: to demonstrate knowledge of how ACAS functions.
        - Criteria: the flight crew member should demonstrate an understanding of the following functions:
          - (a) Surveillance
            - (1) ACAS interrogates other transponder- equipped aircraft within a nominal range of 14 NM.
            - (2) ACAS surveillance range can be reduced in geographic areas with a large number of ground interrogators and/or ACAS II- equipped aircraft.
            - (3) If the operator's ACAS implementation provides for the use of the Mode S extended squitter, the normal surveillance range may be increased beyond the nominal 14 NM. However, this information is not used for collision avoidance purposes.
          - (b) Collision avoidance
            - (1) TAs can be issued against any transponder- equipped aircraft which responds to the ICAO Mode C interrogations, even if the aircraft does not have altitude reporting capability.
            - (2) RAs can be issued only against aircraft that are reporting altitude and in the vertical plane only.

- (3) RAs issued against an ACAS-equipped intruder are co-ordinated to ensure complementary RAs are issued.
- (4) Failure to respond to an RA deprives own aircraft of the collision protection provided by own ACAS.
- (5) Additionally, in ACAS-ACAS encounters, failure to respond to an RA also restricts the choices available to the other aircraft's ACAS and thus renders the other aircraft's ACAS less effective than if own aircraft were not ACAS-equipped.

(B) Advisory thresholds

Objective: to demonstrate knowledge of the criteria for issuing TAs and RAs.

Criteria: the flight crew member should demonstrate an understanding of the methodology used by ACAS to issue TAs and RAs and the general criteria for the issuance of these advisories, including the following:

- (a) ACAS advisories are based on time to closest point of approach (CPA) rather than distance. The time should be short and vertical separation should be small, or projected to be small, before an advisory can be issued. The separation standards provided by ATS are different from the miss distances against which ACAS issues alerts.
- (b) Thresholds for issuing a TA or an RA vary with altitude. The thresholds are larger at higher altitudes.
- (c) A TA occurs from 15 to 48 seconds and an RA from 15 to 35 seconds before the projected CPA.
- (d) RAs are chosen to provide the desired vertical miss distance at CPA. As a result, RAs can instruct a climb or descent through the intruder aircraft's altitude.

(C) ACAS limitations

Objective: to verify that the flight crew member is aware of the limitations of ACAS.

Criteria: the flight crew member should demonstrate knowledge and understanding of ACAS limitations, including the following:

- (a) ACAS will neither track nor display non-transponder-equipped aircraft, nor aircraft not responding to ACAS Mode C interrogations.
- (b) ACAS will automatic ally fail if the input from the aircraft's barometric altimeter, radio altimeter or transponder is lost.
  - (1) In some installations, the loss of information from other on board systems such as an inertial reference system (IRS) or attitude heading reference system (AHRS) may result in an ACAS failure. Individual operators should ensure that their flight crews are aware of the types of failure that will result in an ACAS failure.

- (2) ACAS may react in an improper manner when false altitude information is provided to own ACAS or transmitted by another aircraft. Individual operators should ensure that their flight crew are aware of the types of unsafe conditions that can arise. Flight crew members should ensure that when they are advised, if their own aircraft is transmitting false altitude reports, an alternative altitude reporting source is selected, or altitude reporting is switched off.
- (c) Some aeroplanes within 380 ft above ground level (AGL) (nominal value) are deemed to be 'on ground' and will not be displayed. If ACAS is able to determine an aircraft below this altitude is airborne, it will be displayed.
- (d) ACAS may not display all proximate transponder- equipped aircraft in areas of high density traffic.
- (e) The bearing displayed by ACAS is not sufficiently accurate to support the initiation of horizontal manoeuvres based solely on the traffic display.
- (f) ACAS will neither track nor display intruders with a vertical speed in excess of 10 000 ft/min. In addition, the design implementation may result in some short-term errors in the tracked vertical speed of an intruder during periods of high vertical acceleration by the intruder.
- (g) Ground proximity warning systems/ground collision avoidance systems (GPWSs/GCASs) warnings and wind shear warnings take precedence over ACAS advisories. When either a GPWS/GCAS or wind shear warning is active, ACAS aural annunciations will be inhibited and ACAS will automatically switch to the 'TA only' mode of operation.

(D) ACAS inhibits

Objective: to verify that the flight crew member is aware of the conditions under which certain functions of ACAS are inhibited.

Criteria: the flight crew member should demonstrate knowledge and understanding of the various ACAS inhibits, including the following:

- (a) 'Increase Descent' RAs are inhibited below 1 450 ft AGL;
- (b) 'Descend' RAs are inhibited below 1 100 ft AGL;
- (c) all RAs are inhibited below 1 000 ft AGL;
- (d) all TA aural annunciations are inhibited below 500 ft AGL; and
- (e) altitude and configuration under which 'Climb' and 'Increase Climb' RAs are inhibited. ACAS can still issue 'Climb' and 'Increase Climb' RAs when operating at the aeroplane's certified ceiling. (In some aircraft types, 'Climb' or 'Increase Climb' RAs are never inhibited.)

(ii) Operating procedures

The flight crew member should demonstrate the knowledge required to operate the ACAS avionics and interpret the information presented by ACAS. This training should address the following:

- (A) Use of controls



Objective: to verify that the pilot can properly operate all ACAS and display controls.

Criteria: demonstrate the proper use of controls including:

- (a) aircraft configuration required to initiate a self-test;
- (b) steps required to initiate a self- test;
- (c) recognising when the self-test was successful and when it was unsuccessful. When the self-test is unsuccessful, recognising the reason for the failure and, if possible, correcting the problem;
- (d) recommended usage of range selection. Low ranges are used in the terminal area and the higher display ranges are used in the en- route environment and in the transition between the terminal and en- route environment;
- (e) recognising that the configuration of the display does not affect the ACAS surveillance volume;
- (f) selection of lower ranges when an advisory is issued, to increase display resolution;
- (g) proper configuration to display the appropriate ACAS information without eliminating the display of other needed information;
- (h) if available, recommended usage of the above/below mode selector. The above mode should be used during climb and the below mode should be used during descent; and
- (i) if available, proper selection of the display of absolute or relative altitude and the limitations of using this display if a barometric correction is not provided to ACAS.

(B) Display interpretation

Objective: to verify that the flight crew member understands the meaning of all information that can be displayed by ACAS. The wide variety of display implementations require the tailoring of some criteria. When the training programme is developed, these criteria should be expanded to cover details for the operator's specific display implementation.

Criteria: the flight crew member should demonstrate the ability to properly interpret information displayed by ACAS, including the following:

- (a) other traffic, i.e. traffic within the selected display range that is not proximate traffic, or causing a TA or RA to be issued;
- (b) proximate traffic , i.e. traffic that is within 6 NM and  $\pm 1$  200 ft;
- (c) non- altitude reporting traffic;
- (d) no bearing TAs and RAs;
- (e) off- scale TAs and RAs: the selected range should be changed to ensure that all available information on the intruder is displayed;
- (f) TAs: the minimum available display range which allows the traffic to be displayed should be selected, to provide the maximum display resolution;
- (g) RAs (traffic display): the minimum available display range of the traffic display which allows the traffic to be displayed should be selected, to provide the maximum display resolution;

- (h) RAs (RA display): flight crew members should demonstrate knowledge of the meaning of the red and green areas or the meaning of pitch or flight path angle cues displayed on the RA display. Flight crew members should also demonstrate an understanding of the RA display limitations, i.e. if a vertical speed tape is used and the range of the tape is less than 2 500 ft/min, an increase rate RA cannot be properly displayed; and
- (i) if appropriate, awareness that navigation displays oriented on 'Track-Up' may require a flight crew member to make a mental adjustment for drift angle when assessing the bearing of proximate traffic.

(C) Use of the TA-only mode

Objective: to verify that a flight crew member understands the appropriate times to select the TA-only mode of operation and the limitations associated with using this mode.

Criteria: the flight crew member should demonstrate the following:

- (a) Knowledge of the operator's guidance for the use of TA only.
- (b) Reasons for using this mode. If TA only is not selected when an airport is conducting simultaneous operations from parallel runways separated by less than 1 200 ft, and to some intersecting runways, RAs can be expected. If for any reason TA only is not selected and an RA is received in these situations, the response should comply with the operator's approved procedures.
- (c) All TA aural annunciations are inhibited below 500 ft AGL. As a result, TAs issued below 500 ft AGL may not be noticed unless the TA display is included in the routine instrument scan.

(D) Crew coordination

Objective: to verify that the flight crew member understands how ACAS advisories will be handled.

Criteria: the flight crew member should demonstrate knowledge of the crew procedures that should be used when responding to TAs and RAs, including the following:

- (a) task sharing between the pilot flying and the pilot monitoring;
- (b) expected call-outs; and
- (c) communications with ATC.

(E) Phraseology rules

Objective: to verify that the flight crew member is aware of the rules for reporting RAs to the controller.

Criteria: the flight crew member should demonstrate the following:

- (a) the use of the phraseology contained in ICAO PANS- OPS;
- (b) an understanding of the procedures contained in ICAO PANS-ATM and ICAO Annex 2; and
- (c) the understanding that verbal reports should be made promptly to the appropriate ATC unit:
  - (1) whenever any manoeuvre has caused the aeroplane to deviate from an air traffic clearance;

- (2) when, subsequent to a manoeuvre that has caused the aeroplane to deviate from an air traffic clearance, the aeroplane has returned to a flight path that complies with the clearance; and/or
- (3) when air traffic issue instructions that, if followed, would cause the crew to manoeuvre the aircraft contrary to an RA with which they are complying.

(F) Reporting rules

Objective: to verify that the flight crew member is aware of the rules for reporting RAs to the operator.

Criteria: the flight crew member should demonstrate knowledge of where information can be obtained regarding the need for making written reports to various states when an RA is issued. Various States have different reporting rules and the material available to the flight crew member should be tailored to the operator's operating environment. For operators involved in commercial operations, this responsibility is satisfied by the flight crew member reporting to the operator according to the applicable reporting rules.

(3) Non-essential items: advisory thresholds

Objective: to demonstrate knowledge of the criteria for issuing TAs and RAs.

Criteria: the flight crew member should demonstrate an understanding of the methodology used by ACAS to issue TAs and RAs and the general criteria for the issuance of these advisories, including the following:

- (i) the minimum and maximum altitudes below/above which TAs will not be issued;
- (ii) when the vertical separation at CPA is projected to be less than the ACAS-desired separation, a corrective RA which requires a change to the existing vertical speed will be issued. This separation varies from 300 ft at low altitude to a maximum of 700 ft at high altitude;
- (iii) when the vertical separation at CPA is projected to be just outside the ACAS-desired separation, a preventive RA that does not require a change to the existing vertical speed will be issued. This separation varies from 600 to 800 ft; and
- (iv) RA fixed range thresholds vary between 0.2 and 1.1 NM.

(h) ACAS manoeuvre training

- (1) Demonstration of the flight crew member's ability to use ACAS displayed information to properly respond to TAs and RAs should be carried out in a full flight simulator equipped with an ACAS display and controls similar in appearance and operation to those in the aircraft. If a full flight simulator is utilised, CRM should be practised during this training.
- (2) Alternatively, the required demonstrations can be carried out by means of an interactive CBT with an ACAS display and controls similar in appearance and operation to those in the aircraft. This interactive CBT should depict scenarios in which real-time responses should be made. The flight crew member should be informed whether or not the responses made were correct. If the response was incorrect or inappropriate, the CBT should show what the correct response should be.

- (3) The scenarios included in the manoeuvre training should include: corrective RAs; initial preventive RAs; maintain rate RAs; altitude crossing RAs; increase rate RAs; RA reversals; weakening RAs; and multi- aircraft encounters. The consequences of failure to respond correctly should be demonstrated by reference to actual incidents such as those publicised in EUROCONTROL ACAS II Bulletins (available on the EUROCONTROL website).
- (i) TA responses
- Objective: to verify that the pilot properly interprets and responds to TAs.
- Criteria: the pilot should demonstrate the following:
- (A) Proper division of responsibilities between the pilot flying and the pilot monitoring. The pilot flying should fly the aircraft using any type-specific procedures and be prepared to respond to any RA that might follow. For aircraft without an RA pitch display, the pilot flying should consider the likely magnitude of an appropriate pitch change. The pilot monitoring should provide updates on the traffic location shown on the ACAS display, using this information to help visually acquire the intruder.
  - (B) Proper interpretation of the displayed information. Flight crew members should confirm that the aircraft they have visually acquired is that which has caused the TA to be issued. Use should be made of all information shown on the display, note being taken of the bearing and range of the intruder (amber circle), whether it is above or below (data tag) and its vertical speed direction (trend arrow).
  - (C) Other available information should be used to assist in visual acquisition, including ATC 'party- line' information, traffic flow in use, etc.
  - (D) Because of the limitations described, the pilot flying should not manoeuvre the aircraft based solely on the information shown on the ACAS display. No attempt should be made to adjust the current flight path in anticipation of what an RA would advise, except that if own aircraft is approaching its cleared level at a high vertical rate with a TA present, vertical rate should be reduced to less than 1 500 ft/min.
  - (E) When visual acquisition is attained, and as long as no RA is received, normal right of way rules should be used to maintain or attain safe separation. No unnecessary manoeuvres should be initiated. The limitations of making manoeuvres based solely on visual acquisition, especially at high altitude or at night, or without a definite horizon should be demonstrated as being understood.
- (ii) RA responses
- Objective: to verify that the pilot properly interprets and responds to RAs.
- Criteria: the pilot should demonstrate the following:
- (A) Proper response to the RA, even if it is in conflict with an ATC instruction and even if the pilot believes that there is no threat present.
  - (B) Proper task sharing between the pilot flying and the pilot monitoring. The pilot flying should respond to a corrective RA with appropriate control inputs. The pilot monitoring should monitor the response to the RA and should provide updates on the traffic location by checking the traffic display. Proper crew resource management (CRM) should be used.

- (C) Proper interpretation of the displayed information. The pilot should recognise the intruder causing the RA to be issued (red square on display). The pilot should respond appropriately.
- (D) For corrective RAs, the response should be initiated in the proper direction within five seconds of the RA being displayed. The change in vertical speed should be accomplished with an acceleration of approximately  $\frac{1}{4}$  g (gravitational acceleration of  $9.81 \text{ m/sec}^2$ ).
- (E) Recognition of the initially displayed RA being modified. Response to the modified RA should be properly accomplished, as follows:
  - (a) For increase rate RAs, the vertical speed change should be started within two and a half seconds of the RA being displayed. The change in vertical speed should be accomplished with an acceleration of approximately  $\frac{1}{3}$  g.
  - (b) For RA reversals, the vertical speed reversal should be started within two and a half seconds of the RA being displayed. The change in vertical speed should be accomplished with an acceleration of approximately  $\frac{1}{3}$  g.
  - (c) For RA weakenings, the vertical speed should be modified to initiate a return towards the original clearance.
  - (d) An acceleration of approximately  $\frac{1}{4}$  g will be achieved if the change in pitch attitude corresponding to a change in vertical speed of 1 500 ft/min is accomplished in approximately 5 seconds, and of  $\frac{1}{3}$  g if the change is accomplished in approximately three seconds. The change in pitch attitude required to establish a rate of climb or descent of 1 500 ft/min from level flight will be approximately  $6^\circ$  when the true airspeed (TAS) is 150 kt,  $4^\circ$  at 250 kt, and  $2^\circ$  at 500 kt. (These angles are derived from the formula: 1 000 divided by TAS.)
- (F) Recognition of altitude crossing encounters and the proper response to these RAs.
- (G) For preventive RAs, the vertical speed needle or pitch attitude indication should remain outside the red area on the RA display.
- (H) For maintain rate RAs, the vertical speed should not be reduced. Pilots should recognise that a maintain rate RA may result in crossing through the intruder's altitude.
- (I) When the RA weakens, or when the green 'fly to' indicator changes position, the pilot should initiate a return towards the original clearance and when 'clear of conflict' is annunciated, the pilot should complete the return to the original clearance.
- (J) The controller should be informed of the RA as soon as time and workload permit, using the standard phraseology.
- (K) When possible, an ATC clearance should be complied with while responding to an RA. For example, if the aircraft can level at the assigned altitude while responding to RA (an 'adjust vertical speed' RA (version 7) or 'level off' (version 7.1)) it should be done; the horizontal (turn) element of an ATC instruction should be followed.

- (L) Knowledge of the ACAS multi-aircraft logic and its limitations, and that ACAS can optimise separations from two aircraft by climbing or descending towards one of them. For example, ACAS only considers intruders that it considers to be a threat when selecting an RA. As such, it is possible for ACAS to issue an RA against one intruder that results in a manoeuvre towards another intruder which is not classified as a threat. If the second intruder becomes a threat, the RA will be modified to provide separation from that intruder.
- (i) ACAS initial evaluation
  - (1) The flight crew member's understanding of the academic training items should be assessed by means of a written test or interactive CBT that records correct and incorrect responses to phrased questions.
  - (2) The flight crew member's understanding of the manoeuvre training items should be assessed in a full flight simulator equipped with an ACAS display and controls similar in appearance and operation to those in the aircraft the flight crew member will fly, and the results assessed by a qualified instructor, inspector, or check airman. The range of scenarios should include: corrective RAs; initial preventive RAs; maintain rate RAs; altitude crossing RAs; increase rate RAs; RA reversals; weakening RAs; and multi-threat encounters. The scenarios should also include demonstrations of the consequences of not responding to RAs, slow or late responses, and manoeuvring opposite to the direction called for by the displayed RA.
  - (3) Alternatively, exposure to these scenarios can be conducted by means of an interactive CBT with an ACAS display and controls similar in appearance and operation to those in the aircraft the pilot will fly. This interactive CBT should depict scenarios in which real-time responses should be made and a record made of whether or not each response was correct.
- (j) ACAS recurrent training
  - (1) ACAS recurrent training ensures that flight crew members maintain the appropriate ACAS knowledge and skills. ACAS recurrent training should be integrated into and/or conducted in conjunction with other established recurrent training programmes. An essential item of recurrent training is the discussion of any significant issues and operational concerns that have been identified by the operator. Recurrent training should also address changes to ACAS logic, parameters or procedures and to any unique ACAS characteristics which flight crew members should be made aware of.
  - (2) It is recommended that the operator's recurrent training programmes using full flight simulators include encounters with conflicting traffic when these simulators are equipped with ACAS. The full range of likely scenarios may be spread over a 2-year period. If a full flight simulator, as described above, is not available, use should be made of interactive CBT that is capable of presenting scenarios to which pilot responses should be made in real time.

### **AMC1 CAT.OP.MPA.300 Approach and landing conditions**

#### **IN-FLIGHT DETERMINATION OF THE LANDING DISTANCE**

The in-flight determination of the landing distance should be based on the latest available meteorological or runway state report, preferably not more than 30 minutes before the expected landing time.

### **AMC1 CAT.OP.MPA.305(e) Commencement and continuation of approach**

#### **VISUAL REFERENCES FOR INSTRUMENT APPROACH OPERATIONS**

- (a) NPA, APV and CAT I operations

At DH or MDH, at least one of the visual references specified below should be distinctly visible and identifiable to the pilot:

- (1) elements of the approach lighting system;
- (2) the threshold;
- (3) the threshold markings;
- (4) the threshold lights;
- (5) the threshold identification lights;
- (6) the visual glide slope indicator;
- (7) the touchdown zone or touchdown zone markings;
- (8) the touchdown zone lights;
- (9) FATO/runway edge lights; or
- (10) other visual references specified in the operations manual.

(b) LTS CAT I operations

At DH, the visual references specified below should be distinctly visible and identifiable to the pilot:

- (1) a segment of at least three consecutive lights, being the centreline of the approach lights, or touchdown zone lights, or runway centreline lights, or runway edge lights, or a combination of them;
- (2) this visual reference should include a lateral element of the ground pattern, such as an approach light crossbar or the landing threshold or a barrette of the touchdown zone light unless the operation is conducted utilising an approved HUDLS usable to at least 150 ft.

(c) CAT II or OTS CAT II operations

At DH, the visual references specified below should be distinctly visible and identifiable to the pilot:

- (1) a segment of at least three consecutive lights being the centreline of the approach lights, or touchdown zone lights, or runway centreline lights, or runway edge lights, or a combination of them;
- (2) this visual reference should include a lateral element of the ground pattern, such as an approach light crossbar or the landing threshold or a barrette of the touchdown zone light unless the operation is conducted utilising an approved HUDLS to touchdown.

(d) CAT III operations

- (1) For CAT IIIA operations and for CAT IIIB operations conducted either with fail-passive flight control systems or with the use of an approved HUDLS: at DH, a segment of at least three consecutive lights being the centreline of the approach lights, or touchdown zone lights, or runway centreline lights, or runway edge lights, or a combination of these is attained and can be maintained by the pilot.
- (2) For CAT IIIB operations conducted either with fail-operational flight control systems or with a fail-operational hybrid landing system using a DH: at DH, at least one centreline light is attained and can be maintained by the pilot.
- (3) For CAT IIIB operations with no DH, there is no specification for visual reference with the runway prior to touchdown.

(e) Approach operations utilising EVS — CAT I operations

- (1) At DH, the following visual references should be displayed and identifiable to the pilot on the EVS image:
  - (i) elements of the approach light; or

- (ii) the runway threshold, identified by at least one of the following:
  - (A) the beginning of the runway landing surface,
  - (B) the threshold lights, the threshold identification lights; or
  - (C) the touchdown zone, identified by at least one of the following: the runway touchdown zone landing surface, the touchdown zone lights, the touchdown zone markings or the runway lights.
- (2) At 100 ft above runway threshold elevation, at least one of the visual references specified below should be distinctly visible and identifiable to the pilot without reliance on the EVS:
  - (i) the lights or markings of the threshold; or
  - (ii) the lights or markings of the touchdown zone.
- (f) Approach operations utilising EVS — APV and NPA operations flown with the CDFA technique
  - (1) At DH/MDH, visual references should be displayed and identifiable to the pilot on the EVS image as specified under (a).
  - (2) At 200 ft above runway threshold elevation, at least one of the visual references specified under (a) should be distinctly visible and identifiable to the pilot without reliance on the EVS.

### **GM1 CAT.OP.MPA.305(f) Commencement and continuation of approach**

#### EXPLANATION OF THE TERM 'RELEVANT'

'Relevant' in this context means that part of the runway used during the high-speed phase of the landing down to a speed of approximately 60 kt.

### **GM1 CAT.OP.MPA.315 Flight hours reporting — helicopters**

#### FLIGHT HOURS REPORTING

- (a) The requirement in CAT.OP.MPA.315 may be achieved by making available either:
  - (1) the flight hours flown by each helicopter — identified by its serial number and registration mark — during the previous calendar year; or
  - (2) the total flight hours of each helicopter — identified by its serial number and registration mark — on the 31st of December of the previous calendar year.
- (b) Where possible, the operator should have available, for each helicopter, the breakdown of hours for commercial air transport operations. If the exact hours for the functional activity cannot be established, the estimated proportion will be sufficient.



## **SECTION 2 — Non-motor-powered aircraft**

Reserved

## SUBPART C — Aircraft performance and operating limitations

### SECTION 1 — Aeroplanes

#### Chapter 2 — Performance class A

##### AMC1 CAT.POL.A.200 General

###### WET AND CONTAMINATED RUNWAY DATA

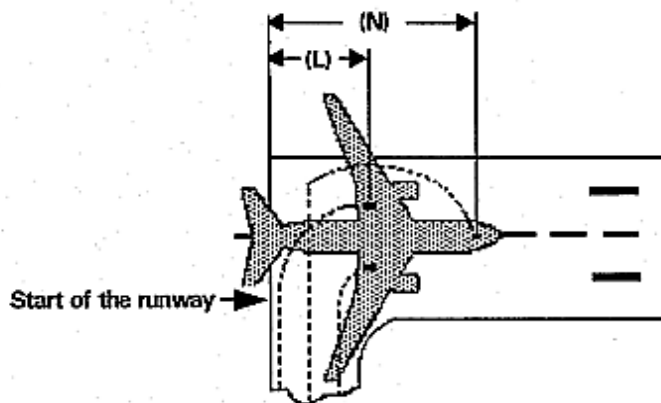
If the performance data have been determined on the basis of a measured runway friction coefficient, the operator should use a procedure correlating the measured runway friction coefficient and the effective braking coefficient of friction of the aeroplane type over the required speed range for the existing runway conditions.

##### AMC1 CAT.POL.A.205 Take-off

###### LOSS OF RUNWAY LENGTH DUE TO ALIGNMENT

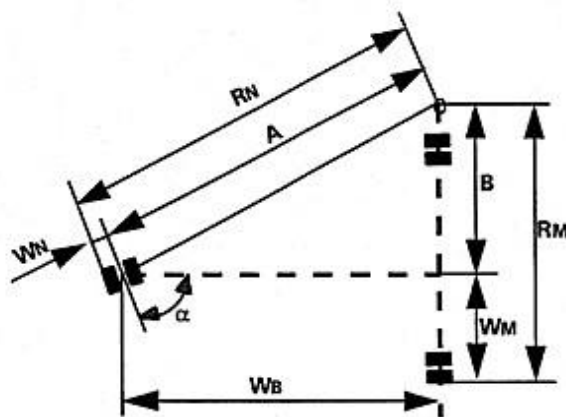
- (a) The length of the runway that is declared for the calculation of take-off distance available (TODA), accelerate-stop distance available (ASDA) and take-off run available (TORA) does not account for line-up of the aeroplane in the direction of take-off on the runway in use. This alignment distance depends on the aeroplane geometry and access possibility to the runway in use. Accountability is usually required for a 90°-taxiway entry to the runway and 180°-turnaround on the runway. There are two distances to be considered:
- (1) the minimum distance of the main wheels from the start of the runway for determining TODA and TORA, 'L'; and
  - (2) the minimum distance of the most forward wheel(s) from the start of the runway for determining ASDA, 'N'.

**Figure 1:** Line-up of the aeroplane in the direction of take-off — L and N



Where the aeroplane manufacturer does not provide the appropriate data, the calculation method given in (b) should be used to determine the alignment distance.

(b) Alignment distance calculation



The distances mentioned in (a)(1) and (a)(2) are:

	90° entry	180° turnaround
$L =$	$RM + X$	$RN + Y$
$N =$	$RM + X + WB$	$RN + Y + WB$

where:

$$RN = A + WN = WB / \cos(90^\circ - \alpha) + WN$$

$$RM = B + WM = WB \tan(90^\circ - \alpha) + WM$$

$X$  = safety distance of outer main wheel during turn to the edge of the runway

$Y$  = safety distance of outer nose wheel during turn to the edge of the runway

Note: Minimum edge safety distances for  $X$  and  $Y$  are specified in FAA AC 150/5300 -13 and ICAO Annex 14, 3.8.3

$RN$  = radius of turn of outer nose wheel  $RM$  = radius of turn of outer main wheel

$WN$  = distance from aeroplane centre-line to outer nose wheel

$WM$  = distance from aeroplane centre-line to outer main wheel

$WB$  = wheel base

$\alpha$  = steering angle.

**GM1 CAT.POL.A.205 Take-off**

## RUNWAY SURFACE CONDITION

- (a) Operation on runways contaminated with water, slush, snow or ice implies uncertainties with regard to runway friction and contaminant drag and, therefore, to the achievable performance and control of the aeroplane during take-off, since the actual conditions may not completely match the assumptions on which the performance information is based. In the case of a contaminated runway, the first option for the commander is to wait until the runway is cleared. If this is impracticable, he/she may consider a take-off, provided that he/she has applied the applicable performance adjustments, and any further safety measures he/she considers justified under the prevailing conditions.
- (b) An adequate overall level of safety will only be maintained if operations in accordance with AMC 25.1591 or equivalent are limited to rare occasions. Where the frequency of such operations on contaminated runways is not limited to rare occasions, the operator should provide additional measures ensuring an equivalent level of safety. Such measures could include special crew training, additional distance factoring and more restrictive wind limitations.

**AMC1 CAT.POL.A.210 Take-off obstacle clearance**

## TAKE- OFF OBSTACLE CLEARANCE

- (a) In accordance with the definitions used in preparing the take-off distance and take-off flight path data provided in the AFM:
  - (1) The net take-off flight path is considered to begin at a height of 35 ft above the runway or clearway at the end of the take-off distance determined for the aeroplane in accordance with (b) below.
  - (2) The take-off distance is the longest of the following distances:
    - (i) 115 % of the distance with all engines operating from the start of the take-off to the point at which the aeroplane is 35 ft above the runway or clearway;
    - (ii) the distance from the start of the take-off to the point at which the aeroplane is 35 ft above the runway or clearway assuming failure of the critical engine occurs at the point corresponding to the decision speed (V<sub>1</sub>) for a dry runway; or
    - (iii) if the runway is wet or contaminated, the distance from the start of the take-off to the point at which the aeroplane is 15 ft above the runway or clearway assuming failure of the critical engine occurs at the point corresponding to the decision speed (V<sub>1</sub>) for a wet or contaminated runway.
- (b) The net take-off flight path, determined from the data provided in the AFM in accordance with (a)(1) and (a)(2), should clear all relevant obstacles by a vertical distance of 35 ft. When taking off on a wet or contaminated runway and an engine failure occurs at the point corresponding to the decision speed (V<sub>1</sub>) for a wet or contaminated runway, this implies that the aeroplane can initially be as much as 20 ft below the net take-off flight path in accordance with (a) and, therefore, may clear close-in obstacles by only 15 ft. When taking off on wet or contaminated runways, the operator should exercise special care with respect to obstacle assessment, especially if a take-off is obstacle-limited and the obstacle density is high.

**AMC2 CAT.POL.A.210 Take-off obstacle clearance**

## EFFECT OF BANK ANGLES

- (a) The AFM generally provides a climb gradient decrement for a 15° bank turn. For bank angles of less than 15°, a proportionate amount should be applied unless the manufacturer or AFM has provided other data.
- (b) Unless otherwise specified in the AFM or other performance or operating manuals from the manufacturer, acceptable adjustments to assure adequate stall margins and gradient corrections are provided by the following table:

**Table 1:** Effect of bank angles

Bank	Speed	Gradient correction
15°	V <sub>2</sub>	1 x AFM 15° gradient loss
20°	V <sub>2</sub> + 5 kt	2 x AFM 15° gradient loss
25°	V <sub>2</sub> + 10 kt	3 x AFM 15° gradient loss

**AMC3 CAT.POL.A.210 Take-off obstacle clearance**

## REQUIRED NAVIGATIONAL ACCURACY

- (a) Navigation systems
 

The obstacle accountability semi-widths of 300 m and 600 m may be used if the navigation system under OEI conditions provides a two standard deviation accuracy of 150 m and 300 m respectively.
- (b) Visual course guidance
  - (1) The obstacle accountability semi-widths of 300 m and 600 m may be used where navigational accuracy is ensured at all relevant points on the flight path by use of external references. These references may be considered visible from the flight crew compartment if they are situated more than 45° either side of the intended track and with a depression of not greater than 20° from the horizontal.
  - (2) For visual course guidance navigation, the operator should ensure that the weather conditions prevailing at the time of operation, including ceiling and visibility, are such that the obstacle and/or ground reference points can be seen and identified. The operations manual should specify, for the aerodrome(s) concerned, the minimum weather conditions which enable the flight crew to continuously determine and maintain the correct flight path with respect to ground reference points, so as to provide a safe clearance with respect to obstructions and terrain as follows:
    - (i) the procedure should be well-defined with respect to ground reference points so that the track to be flown can be analysed for obstacle clearance requirements;
    - (ii) the procedure should be within the capabilities of the aeroplane with respect to forward speed, bank angle and wind effects;
    - (iii) a written and/or pictorial description of the procedure should be provided for crew use; and

- (iv) the limiting environmental conditions (such as wind, the lowest cloud base, ceiling, visibility, day/night, ambient lighting, obstruction lighting) should be specified.

**GM1 CAT.POL.A.210 Take-off obstacle clearance**

**CONTINGENCY PROCEDURES FOR OBSTACLES CLEARANCES**

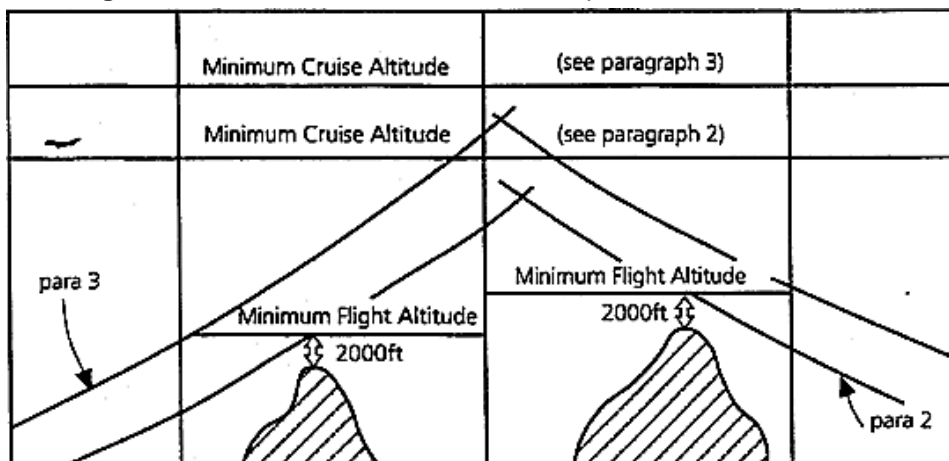
If compliance with CAT.POL.A.210 is based on an engine failure route that differs from the all engine departure route or SID normal departure, a ‘deviation point’ can be identified where the engine failure route deviates from the normal departure route. Adequate obstacle clearance along the normal departure route with failure of the critical engine at the deviation point will normally be available. However, in certain situations the obstacle clearance along the normal departure route may be marginal and should be checked to ensure that, in case of an engine failure after the deviation point, a flight can safely proceed along the normal departure route.

**AMC1 CAT.POL.A.215 En-route – one-engine-inoperative (OEI)**

**ROUTE ANALYSIS**

- (a) The high terrain or obstacle analysis required should be carried out by a detailed analysis of the route.
- (b) A detailed analysis of the route should be made using contour maps of the high terrain and plotting the highest points within the prescribed corridor’s width along the route. The next step is to determine whether it is possible to maintain level flight with OEI 1 000 ft above the highest point of the crossing. If this is not possible, or if the associated weight penalties are unacceptable, a drift down procedure should be worked out, based on engine failure at the most critical point and clearing critical obstacles during the drift down by at least 2 000 ft. The minimum cruise altitude is determined by the intersection of the two drift down paths, taking into account allowances for decision making (see Figure 1). This method is time-consuming and requires the availability of detailed terrain maps.
- (c) Alternatively, the published minimum flight altitudes (MEA or minimum off- route altitude (MORA)) should be used for determining whether OEI level flight is feasible at the minimum flight altitude, or if it is necessary to use the published minimum flight altitudes as the basis for the drift down construction (see Figure 1). This procedure avoids a detailed high terrain contour analysis, but could be more penalising than taking the actual terrain profile into account as in (b).
- (d) In order to comply with CAT.POL.A.215 (c), one means of compliance is the use of MORA and, with CAT.POL.A.215 (d), MEA provided that the aeroplane meets the navigational equipment standard assumed in the definition of MEA.

**Figure 1:** Intersection of the two drift down paths



*Note: MEA or MORA normally provide the required 2 000 ft obstacle clearance for drift down. However, at and below 6 000 ft altitude, MEA and MORA cannot be used directly as only 1 000 ft clearance is ensured.*

### **AMC1 CAT.POL.A.225 Landing — destination and alternate aerodromes**

#### ALTITUDE MEASURING

The operator should use either pressure altitude or geometric altitude for its operation and this should be reflected in the operations manual.

### **AMC2 CAT.POL.A.225 Landing — destination and alternate aerodromes**

#### MISSED APPROACH

- (a) For instrument approaches with a missed approach climb gradient greater than 2.5 %, the operator should verify that the expected landing mass of the aeroplane allows for a missed approach with a climb gradient equal to or greater than the applicable missed approach gradient in the OEI missed approach configuration and at the associated speed.
- (b) For instrument approaches with DH below 200 ft, the operator should verify that the expected landing mass of the aeroplane allows a missed approach gradient of climb, with the critical engine failed and with the speed and configuration used for a missed approach of at least 2.5 %, or the published gradient, whichever is greater.

### **GM1 CAT.POL.A.225 Landing — destination and alternate aerodromes**

#### MISSED APPROACH GRADIENT

- (a) Where an aeroplane cannot achieve the missed approach gradient specified in AMC2 CAT.POL.A.225, when operating at or near maximum certificated landing mass and in engine-out conditions, the operator has the opportunity to propose an alternative means of compliance to the competent authority demonstrating that a missed approach can be executed safely taking into account appropriate mitigating measures.
- (b) The proposal for an alternative means of compliance may involve the following:
  - (1) considerations to mass, altitude and temperature limitations and wind for the missed approach;
  - (2) a proposal to increase the DA/H or MDA/H; and
  - (3) a contingency procedure ensuring a safe route and avoiding obstacles.

### **AMC1 CAT.POL.A.230 Landing — dry runways**

#### FACTORING OF AUTOMATIC LANDING DISTANCE PERFORMANCE DATA

In those cases where the landing requires the use of an automatic landing system, and the distance published in the AFM includes safety margins equivalent to those contained in CAT.POL.A.230 (a)(1) and CAT.POL.A.235, the landing mass of the aeroplane should be the lesser of:

- (a) the landing mass determined in accordance with CAT.POL.A.230 (a)(1) or CAT.POL.A.235 as appropriate; or
- (b) the landing mass determined for the automatic landing distance for the appropriate surface condition, as given in the AFM or equivalent document. Increments due to system features such as beam location or elevations, or procedures such as use of overspeed, should also be included.

**GM1 CAT.POL.A.230 Landing — dry runways**

## LANDING MASS

CAT.POL.A.230 establishes two considerations in determining the maximum permissible landing mass at the destination and alternate aerodromes:

- (a) Firstly, the aeroplane mass will be such that on arrival the aeroplane can be landed within 60 % or 70 % (as applicable) of the landing distance available (LDA) on the most favourable (normally the longest) runway in still air. Regardless of the wind conditions, the maximum landing mass for an aerodrome/aeroplane configuration at a particular aerodrome cannot be exceeded.
- (b) Secondly, consideration should be given to anticipated conditions and circumstances. The expected wind, or ATC and noise abatement procedures, may indicate the use of a different runway. These factors may result in a lower landing mass than that permitted under (a), in which case dispatch should be based on this lesser mass.
- (c) The expected wind referred to in (b) is the wind expected to exist at the time of arrival.



## Chapter 3 — Performance class B

### AMC1 CAT.POL.A.305 Take-off

#### RUNWAY SURFACE CONDITION

- (a) Unless otherwise specified in the AFM or other performance or operating manuals from the manufacturer, the variables affecting the take-off performance and the associated factors that should be applied to the AFM data are shown in Table 1 below. They should be applied in addition to the operational factors as prescribed in CAT.POL.A.305.

**Table 1:** Runway surface condition — Variables

Surface type	Condition	Factor
Grass (on firm soil)	Dry	1.2
up to 20 cm long	Wet	1.3
Paved	Wet	1.0

- (b) The soil should be considered firm when there are wheel impressions but no rutting.
- (c) When taking off on grass with a single-engined aeroplane, care should be taken to assess the rate of acceleration and consequent distance increase.
- (d) When making a rejected take-off on very short grass that is wet and with a firm subsoil, the surface may be slippery, in which case the distances may increase significantly.

### AMC2 CAT.POL.A.305 Take-off

#### RUNWAY SLOPE

Unless otherwise specified in the AFM, or other performance or operating manuals from the manufacturer, the take-off distance should be increased by 5 % for each 1 % of upslope except that correction factors for runways with slopes in excess of 2 % should only be applied when the operator has demonstrated to the competent authority that the necessary data in the AFM or the operations manual contain the appropriated procedures and the crew is trained to take-off in runway with slopes in excess of 2 %.

### GM1 CAT.POL.A.305 Take-off

#### RUNWAY SURFACE CONDITION

- (a) Due to the inherent risks, operations from contaminated runways are inadvisable, and should be avoided whenever possible. Therefore, it is advisable to delay the take-off until the runway is cleared.
- (b) Where this is impracticable, the commander should also consider the excess runway length available including the criticality of the overrun area.

## AMC1 CAT.POL.A.310 Take-off obstacle clearance — multi-engined aeroplanes

### TAKE- OFF FLIGHT PATH — VISUAL COURSE GUIDANCE NAVIGATION

- (a) In order to allow visual course guidance navigation, the weather conditions prevailing at the time of operation, including ceiling and visibility, should be such that the obstacle and/or ground reference points can be seen and identified. For VFR operations by night, the visual course guidance should be considered available when the flight visibility is 1 500 m or more.
- (b) The operations manual should specify, for the aerodrome(s) concerned, the minimum weather conditions that enable the flight crew to continuously determine and maintain the correct flight path with respect to ground reference points so as to provide a safe clearance with respect to obstructions and terrain as follows:
  - (1) the procedure should be well defined with respect to ground reference points so that the track to be flown can be analysed for obstacle clearance requirements;
  - (2) the procedure should be within the capabilities of the aeroplane with respect to forward speed, bank angle and wind effects;
  - (3) a written and/or pictorial description of the procedure should be provided for crew use; and
  - (4) the limiting environmental conditions should be specified (e.g. wind, cloud, visibility, day/night, ambient lighting, obstruction lighting).

## AMC2 CAT.POL.A.310 Take-off obstacle clearance — multi-engined aeroplanes

### TAKE-OFF FLIGHT PATH CONSTRUCTION

- (a) For demonstrating that the aeroplane clears all obstacles vertically, a flight path should be constructed consisting of an all-engines segment to the assumed engine failure height, followed by an engine-out segment. Where the AFM does not contain the appropriate data, the approximation given in (b) may be used for the all- engines segment for an assumed engine failure height of 200 ft, 300 ft, or higher.
- (b) Flight path construction
  - (1) All- engines segment (50 ft to 300 ft)  
The average all-engines gradient for the all- engines flight path segment starting at an altitude of 50 ft at the end of the take-off distance ending at or passing through the 300 ft point is given by the following formula:

$$Y_{300} = \frac{0.57(Y_{ERC})}{1 + (V_{ERC}^2 - V_2^2) / 5647}$$

*The factor of 0.77 as required by CAT.POL.A.310 is already included where:*

*Y<sub>300</sub> = average all-engines gradient from 50 ft to 300 ft;*

*Y<sub>ERC</sub> = scheduled all engines en-route gross climb gradient;*

*V<sub>ERC</sub> = en-route climb speed, all engines knots true airspeed (TAS);*

*V<sub>2</sub> = take- off speed at 50 ft, knots TAS;*

- (2) All-engines segment (50 ft to 200 ft)

This may be used as an alternative to (b)(1) where weather minima permit. The average all-engines gradient for the all-engines flight path segment starting at an altitude of 50 ft at the end of the take-off distance ending at or passing through the 200 ft point is given by the following formula:

$$Y_{200} = \frac{0.51(Y_{ERC})}{1 + (V_{ERC}^2 - V_2^2) / 3388}$$

The factor of 0.77 as required by CAT.POL.A.310 is already included where:

$Y_{200}$  = average all-engines gradient from 50 ft to 200 ft;

$Y_{ERC}$  = scheduled all engines en-route gross climb gradient;

$V_{ERC}$  = en-route climb speed, all engines, knots TAS;

$V_2$  = take-off speed at 50 ft, knots TAS.

- (3) All-engines segment (above 300 ft)

The all-engines flight path segment continuing from an altitude of 300 ft is given by the AFM en-route gross climb gradient, multiplied by a factor of 0.77.

- (4) The OEI flight path

The OEI flight path is given by the OEI gradient chart contained in the AFM.

## **GM1 CAT.POL.A.310 Take-off obstacle clearance — multi-engined aeroplanes**

### **OBSTACLE CLEARANCE IN LIMITED VISIBILITY**

- (a) Unlike the airworthiness codes applicable for performance class A aeroplanes, those for performance class B aeroplanes do not necessarily provide for engine failure in all phases of flight. It is accepted that performance accountability for engine failure need not be considered until a height of 300 ft is reached.
- (b) The weather minima given up to and including 300 ft imply that if a take-off is undertaken with minima below 300 ft, an OEI flight path should be plotted starting on the all-engines take-off flight path at the assumed engine failure height. This path should meet the vertical and lateral obstacle clearance specified in CAT.POL.A.310. Should engine failure occur below this height, the associated visibility is taken as being the minimum that would enable the pilot to make, if necessary, a forced landing broadly in the direction of the take-off. At or below 300 ft, a circle and land procedure is extremely inadvisable. The weather minima provisions specify that, if the assumed engine failure height is more than 300 ft, the visibility should be at least 1 500 m and, to allow for manoeuvring, the same minimum visibility should apply whenever the obstacle clearance criteria for a continued take-off cannot be met.

## **GM2 CAT.POL.A.310 Take-off obstacle clearance — multi-engined aeroplanes**

### **TAKE-OFF FLIGHT PATH CONSTRUCTION**

- (a) This GM provides examples to illustrate the method of take-off flight path construction given in AMC2 CAT.POL.A.310. The examples are based on an aeroplane for which the AFM shows, at a given mass, altitude, temperature and wind component the following performance data:
- factored take-off distance – 1 000 m;
  - take-off speed,  $V_2$  – 90 kt;
  - en-route climb speed,  $V_{ERC}$  – 120 kt;
  - en-route all-engines climb gradient,  $Y_{ERC}$  – 0.2;

- en-route OEI climb gradient, Y<sub>ERC-1</sub> – 0.032.

(1) Assumed engine failure height 300 ft

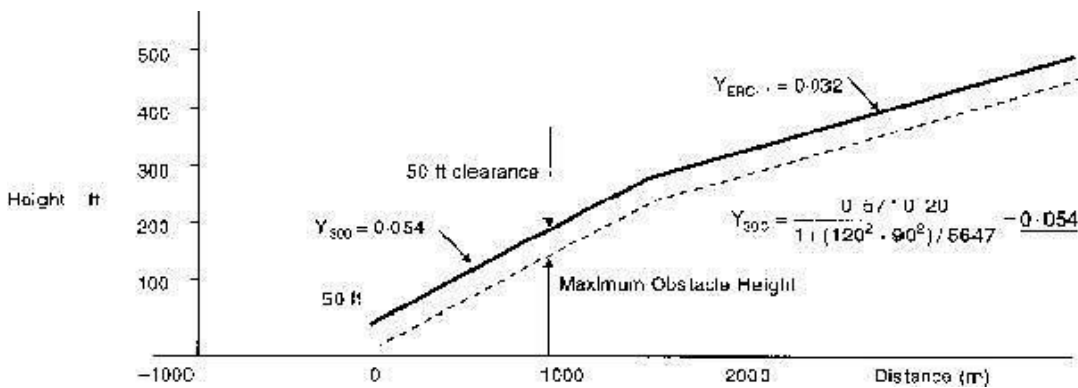
The average all-engines gradient from 50 ft to 300 ft may be read from Figure 1 or calculated with the following formula:

$$Y_{300} = \frac{0.57(Y_{ERC})}{1 + (V_{ERC}^2 - V_2^2) / 5647}$$

The factor of 0.77 as required by CAT.POL.A.310 is already included where:

- Y<sub>300</sub> = average all-engines gradient from 50 ft to 300 ft;
- Y<sub>ERC</sub> = scheduled all engines en-route gross climb gradient;
- V<sub>ERC</sub> = en- route climb speed, all engines knots TAS; and
- V<sub>2</sub> = take- off speed at 50 ft, knots TAS.

**Figure 1:** Assumed engine failure height 300 ft



(2) Assumed engine failure height 200 ft

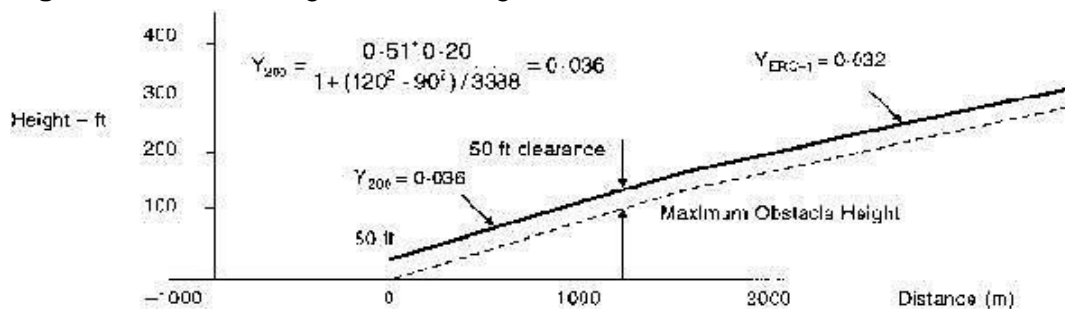
The average all-engines gradient from 50 ft to 200 ft may be read from Figure 2 or calculated with the following formula:

$$Y_{200} = \frac{0.51(Y_{ERC})}{1 + (V_{ERC}^2 - V_2^2) / 3388}$$

The factor of 0.77 as required by CAT.POL.A.310 is already included where:

- Y<sub>200</sub> = average all-engines gradient from 50 ft to 200 ft;
- Y<sub>ERC</sub> = scheduled all engines en-route gross gradient;
- V<sub>ERC</sub> = en-route climb speed, all engines, knots TAS; and
- V<sub>2</sub> = take- off speed at 50 ft, knots TAS.

**Figure 2: Assumed engine failure height 200 ft**



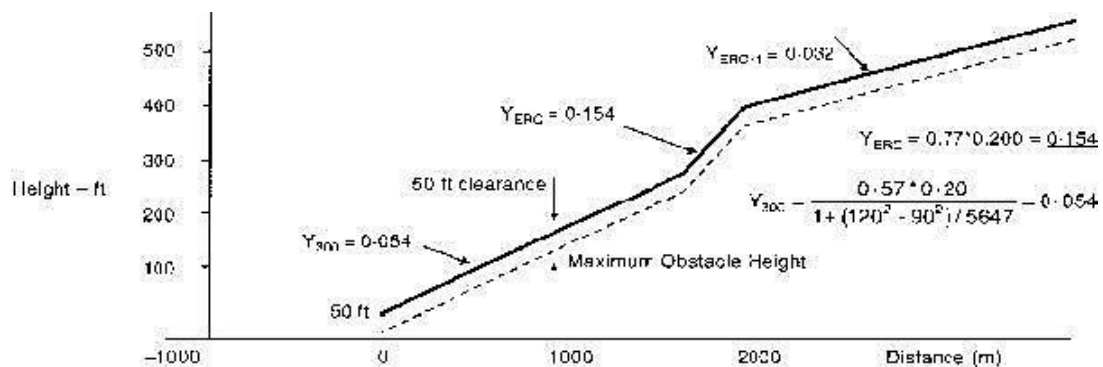
(3) Assumed engine failure height less than 200 ft

Construction of a take-off flight path is only possible if the AFM contains the required flight path data.

(4) Assumed engine failure height more than 300 ft.

The construction of a take-off flight path for an assumed engine failure height of 400 ft is illustrated below.

Figure 3: Assumed engine failure height less than 200 ft



**GM1 CAT.POL.A.315 En-route — multi-engined aeroplanes**

**CRUISING ALTITUDE**

- (a) The altitude at which the rate of climb equals 300 ft per minute is not a restriction on the maximum cruising altitude at which the aeroplane can fly in practice, it is merely the maximum altitude from which the driftdown procedure can be planned to start.
- (b) Aeroplanes may be planned to clear en- route obstacles assuming a driftdown procedure, having first increased the scheduled en-route OEI descent data by 0.5 % gradient.

**AMC1 CAT.POL.A.320 En-route — single-engined aeroplanes**

**ENGINE FAILURE**

CAT.POL.A.320 (a) requires the operator to ensure that in the event of an engine failure, the aeroplane should be capable of reaching a point from which a safe forced landing can be made. Unless otherwise specified by the competent authority, this point should be 1 000 ft above the intended landing area.

**GM1 CAT.POL.A.320 En-route — single-engined aeroplanes****ENGINE FAILURE**

- (a) In the event of an engine failure, single-engined aeroplanes have to rely on gliding to a point suitable for a safe forced landing. Such a procedure is clearly incompatible with flight above a cloud layer that extends below the relevant minimum safe altitude.
- (b) The operator should first increase the scheduled engine- inoperative gliding performance data by 0.5 % gradient when verifying the en- route clearance of obstacles and the ability to reach a suitable place for a forced landing.
- (c) The altitude at which the rate of climb equals 300 ft per minute is not a restriction on the maximum cruising altitude at which the aeroplane can fly in practice, it is merely the maximum altitude from which the engine-inoperative procedure can be planned to start.

**AMC1 CAT.POL.A.325 Landing — destination and alternate aerodromes****ALTITUDE MEASURING**

The operator should use either pressure altitude or geometric altitude for its operation and this should be reflected in the operations manual.

**AMC1 CAT.POL.A.330 Landing — dry runways****LANDING DISTANCE CORRECTION FACTORS**

- (a) Unless otherwise specified in the AFM, or other performance or operating manuals from the manufacturers, the variable affecting the landing performance and the associated factor that should be applied to the AFM data are shown in the table below. It should be applied in addition to the operational factors as prescribed in CAT.POL.A.330 (a).

Table 1: Landing distance correction factors

Surface type	Factor
Grass (on firm soil up to 20 cm long)	1.15

- (b) The soil should be considered firm when there are wheel impressions but no rutting.

**AMC2 CAT.POL.A.330 Landing — dry runways****RUNWAY SLOPE**

Unless otherwise specified in the AFM, or other performance or operating manuals from the manufacturer, the landing distances required should be increased by 5 % for each 1 % of downslope.

**GM1 CAT.POL.A.330 Landing — dry runways****LANDING MASS**

CAT.POL.A.330 establishes two considerations in determining the maximum permissible landing mass at the destination and alternate aerodromes.

- (a) Firstly, the aeroplane mass will be such that on arrival the aeroplane can be landed within 70 % of the LDA on the most favourable (normally the longest) runway in still air. Regardless of the wind conditions, the maximum landing mass for an aerodrome/aeroplane configuration at a particular aerodrome cannot be exceeded.

- (b) Secondly, consideration should be given to anticipated conditions and circumstances. The expected wind, or ATC and noise abatement procedures may indicate the use of a different runway. These factors may result in a lower landing mass than that permitted under (a), in which case dispatch should be based on this lesser mass.
- (c) The expected wind referred to in (b) is the wind expected to exist at the time of arrival.

### **GM1 CAT.POL.A.335 Landing — wet and contaminated runways**

#### **LANDING ON WET GRASS RUNWAYS**

- (a) When landing on very short grass that is wet and with a firm subsoil, the surface may be slippery, in which case the distances may increase by as much as 60 % (1.60 factor).
- (b) As it may not be possible for a pilot to determine accurately the degree of wetness of the grass, particularly when airborne, in cases of doubt, the use of the wet factor (1.15) is recommended.

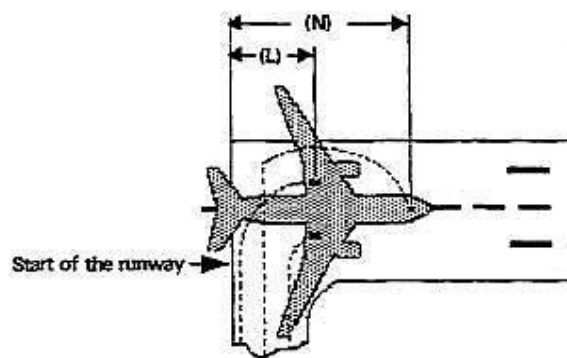
## Chapter 4 — Performance class C

### AMC1 CAT.POL.A.400 Take-off

#### LOSS OF RUNWAY LENGTH DUE TO ALIGNMENT

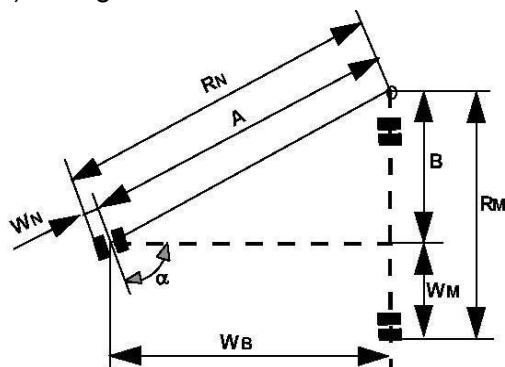
- (a) The length of the runway that is declared for the calculation of TODA, ASDA and TORA does not account for line-up of the aeroplane in the direction of take-off on the runway in use. This alignment distance depends on the aeroplane geometry and access possibility to the runway in use. Accountability is usually required for a 90°- taxiway entry to the runway and 180°-turnaround on the runway. There are two distances to be considered:
- (1) the minimum distance of the main wheels from the start of the runway for determining TODA and TORA, 'L'; and
  - (2) the minimum distance of the most forward wheel(s) from the start of the runway for determining ASDA, 'N'.

**Figure 1:** Line- up of the aeroplane in the direction of take-off — L and N



Where the aeroplane manufacturer does not provide the appropriate data, the calculation method given in (b) may be used to determine the alignment distance.

- (b) Alignment distance calculation





The distances mentioned in (a)(1) and (a)(2) above are:

	90°- entry	180°- turnaround
L =	RM + X	RN + Y
N =	RM + X + WB	RN + Y + WB

$$RN = A + WN = \cos(90^\circ - \alpha)$$

$$RM = B + WM = WB \tan(90^\circ - \alpha) + WM$$

*X = safety distance of outer main wheel during turn to the edge of the runway*

*Y = safety distance of outer nose wheel during turn to the edge of the runway*

*Note: Minimum edge safety distances for X and Y are specified in FAA AC 150/5300-13 and ICAO Annex 14, 3.8.3*

*RN = radius of turn of outer nose wheel*

*RM = radius of turn of outer main wheel*

*WN = distance from aeroplane centre-line to outer nose wheel*

*WM = distance from aeroplane centre-line to outer main wheel*

*WB = wheel base*

*$\alpha$  = steering angle.*

## AMC2 CAT.POL.A.400 Take-off

### RUNWAY SLOPE

Unless otherwise specified in the AFM, or other performance or operating manuals from the manufacturers, the take-off distance should be increased by 5 % for each 1 % of upslope. However, correction factors for runways with slopes in excess of 2 % should only be applied when:

- the operator has demonstrated to the competent authority that the necessary data in the AFM or the operations manual contain the appropriated procedures; and
- the crew is trained to take-off on runways with slopes in excess of 2 %.

## GM1 CAT.POL.A.400 Take-off

### RUNWAY SURFACE CONDITION

Operation on runways contaminated with water, slush, snow or ice implies uncertainties with regard to runway friction and contaminant drag and, therefore, to the achievable performance and control of the aeroplane during take-off, since the actual conditions may not completely match the assumptions on which the performance information is based. An adequate overall level of safety can, therefore, only be maintained if such operations are limited to rare occasions. In case of a contaminated runway, the first option for the commander is to wait until the runway is cleared. If this is impracticable, he/she may consider a take-off, provided that he/she has applied the applicable performance adjustments, and any further safety measures he/she considers justified under the prevailing conditions.

## AMC1 CAT.POL.A.405 Take-off obstacle clearance

### EFFECT OF BANK ANGLES

- The AFM generally provides a climb gradient decrement for a 15° bank turn. Unless otherwise specified in the AFM or other performance or operating manuals from the manufacturer, acceptable adjustments to assure adequate stall margins and gradient corrections are provided by the following:

Table 1: Effect of bank angles

Bank	Speed	Gradient correction
15°	V2	1 x AFM 15° gradient loss
20°	V2 + 5 kt	2 x AFM 15° gradient loss
25°	V2 + 10 kt	3 x AFM 15° gradient loss

- (b) For bank angles of less than 15°, a proportionate amount may be applied, unless the manufacturer or AFM has provided other data.

## AMC2 CAT.POL.A.405 Take-off obstacle clearance

### REQUIRED NAVIGATIONAL ACCURACY

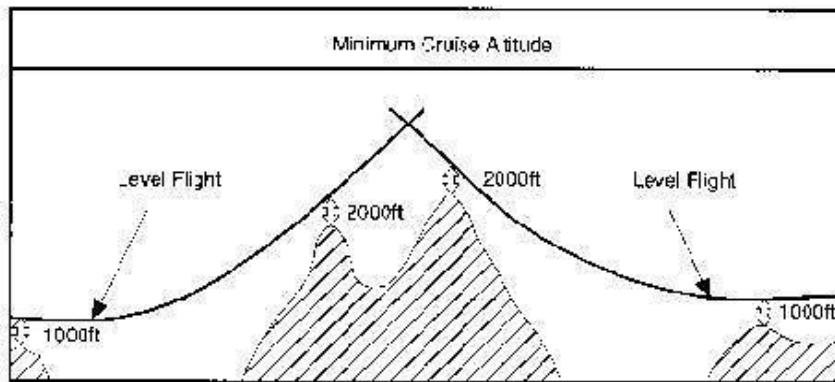
- (a) Navigation systems  
The obstacle accountability semi-widths of 300 m and 600 m may be used if the navigation system under OEI conditions provides a two-standard deviation accuracy of 150 m and 300 m respectively.
- (b) Visual course guidance
- (1) The obstacle accountability semi-widths of 300 m and 600 m may be used where navigational accuracy is ensured at all relevant points on the flight path by use of external references. These references may be considered visible from the flight crew compartment if they are situated more than 45° either side of the intended track and with a depression of not greater than 20° from the horizontal.
  - (2) For visual course guidance navigation, the operator should ensure that the weather conditions prevailing at the time of operation, including ceiling and visibility, are such that the obstacle and/or ground reference points can be seen and identified. The operations manual should specify, for the aerodrome(s) concerned, the minimum weather conditions that enable the flight crew to continuously determine and maintain the correct flight path with respect to ground reference points, so as to provide a safe clearance with respect to obstructions and terrain as follows:
    - (i) the procedure should be well defined with respect to ground reference points so that the track to be flown can be analysed for obstacle clearance requirements;
    - (ii) the procedure should be within the capabilities of the aeroplane with respect to forward speed, bank angle and wind effects;
    - (iii) a written and/or pictorial description of the procedure should be provided for crew use; and
    - (iv) the limiting environmental conditions (such as wind, the lowest cloud base, ceiling, visibility, day/night, ambient lighting, obstruction lighting) should be specified.

**AMC1 CAT.POL.A.415 En-route – OEI**

ROUTE ANALYSIS

The high terrain or obstacle analysis should be carried out by making a detailed analysis of the route using contour maps of the high terrain, and plotting the highest points within the prescribed corridor width along the route. The next step is to determine whether it is possible to maintain level flight with OEI 1 000 ft above the highest point of the crossing. If this is not possible, or if the associated weight penalties are unacceptable, a drift down procedure must be evaluated, based on engine failure at the most critical point, and must show obstacle clearance during the drift down by at least 2 000 ft. The minimum cruise altitude is determined from the drift down path, taking into account allowances for decision making, and the reduction in the scheduled rate of climb (See Figure 1).

**Figure 1:** Intersection of the drift down paths



**AMC1 CAT.POL.A.425 Landing — destination and alternate aerodromes**

ALTITUDE MEASURING

The operator should use either pressure altitude or geometric altitude for its operation and this should be reflected in the operations manual.

**AMC1 CAT.POL.A.430 Landing — dry runways**

LANDING DISTANCE CORRECTION FACTORS

- (a) Unless otherwise specified in the AFM or other performance or operating manuals from the manufacturers, the variables affecting the landing performance and the associated factors to be applied to the AFM data are shown in the table below. It should be applied in addition to the factor specified in CAT.POL.A.430.

**Table 1:** Landing distance correction factor

Surface type	fact or
Grass (on firm soil up to 20 cm long)	1.2

- (b) The soil should be considered firm when there are wheel impressions, but no rutting.

**AMC2 CAT.POL.A.430 Landing — dry runways**

## RUNWAY SLOPE

Unless otherwise specified in the AFM, or other performance or operating manuals from the manufacturer, the landing distances required should be increased by 5 % for each 1 % of downslope.

**GM1 CAT.POL.A.430 Landing — dry runways**

## LANDING MASS

CAT.POL.A.430 establishes two considerations in determining the maximum permissible landing mass at the destination and alternate aerodromes.

- (a) Firstly, the aeroplane mass will be such that on arrival the aeroplane can be landed within 70 % of the LDA on the most favourable (normally the longest) runway in still air. Regardless of the wind conditions, the maximum landing mass for an aerodrome/aeroplane configuration at a particular aerodrome cannot be exceeded.
- (b) Secondly, consideration should be given to anticipated conditions and circumstances. The expected wind, or ATC and noise abatement procedures may indicate the use of a different runway. These factors may result in a lower landing mass than that permitted under (a), in which case dispatch should be based on this lesser mass.
- (c) The expected wind referred to in (b) is the wind expected to exist at the time of arrival.

## **SECTION 2 — Helicopters**

### **Chapter 1 — General requirements**

#### **GM1 CAT.POL.H.105(c)(3)(ii)(A) General**

##### REPORTED HEADWIND COMPONENT

The reported headwind component should be interpreted as being that reported at the time of flight planning and may be used, provided there is no significant change of unfactored wind prior to take-off.

#### **GM1 CAT.POL.H.110(a)(2)(i) Obstacle accountability**

##### COURSE GUIDANCE

Standard course guidance includes automatic direction finder (ADF) and VHF omnidirectional radio range (VOR) guidance.

Accurate course guidance includes ILS, MLS or other course guidance providing an equivalent navigational accuracy.

## Chapter 2 — Performance class 1

### GM1 CAT.POL.H.200 & CAT.POL.H.300 & CAT.POL.H.400 General

#### CATEGORY A AND CATEGORY B

- (a) Helicopters that have been certified according to any of the following standards are considered to satisfy the Category A criteria. Provided that they have the necessary performance information scheduled in the AFM, such helicopters are, therefore, eligible for performance class 1 or 2 operations:
- (1) certification as Category A under CS-27 or CS-29;
  - (2) certification as Category A under JAR- 27 or JAR- 29;
  - (3) certification as Category A under FAR Part 29;
  - (4) certification as group A under BCAR Section G; and
  - (5) certification as group A under BCAR-29.
- (b) In addition to the above, certain helicopters have been certified under FAR Part 27 and with compliance with FAR Part 29 engine isolation requirements as specified in FAA Advisory Circular AC 27- 1. Provided that compliance is established with the following additional requirements of CS- 29:
- (1) CS 29.1027(a) Independence of engine and rotor drive system lubrication;
  - (2) CS 29.1187(e);
  - (3) CS 29.1195(a) & (b) Provision of a one-shot fire extinguishing system for each engine;
    - (i) The requirement to fit a fire extinguishing system may be waived if the helicopter manufacturer can demonstrate equivalent safety, based on service experience for the entire fleet showing that the actual incidence of fires in the engine fire zones has been negligible.
  - (4) CS 29.1197;
  - (5) CS 29.1199;
  - (6) CS 29.1201; and
  - (7) CS 29.1323(c)(1) Ability of the airspeed indicator to consistently identify the take-off decision point,
- these helicopters are considered to satisfy the requirement to be certified as equivalent to Category A.
- (c) The performance operating rules of JAR-OPS 3, which were transposed into this Part, were drafted in conjunction with the performance requirements of JAR-29 Issue 1 and FAR Part 29 at amendment 29- 39. For helicopters certificated under FAR Part 29 at an earlier amendment, or under BCAR section G or BCAR-29, performance data will have been scheduled in the AFM according to these earlier requirements. This earlier scheduled data may not be fully compatible with this Part.
- (d) Before any AOC is issued under which performance class 1 or 2 operations are conducted, it should be established that scheduled performance data are available that are compatible with the requirements of performance class 1 and 2 respectively.
- (e) Any properly certified helicopter is considered to satisfy the Category B criteria. If appropriately equipped (in accordance with CAT.IDE.H), such helicopters are, therefore, eligible for performance class 3 operations.

**AMC1 CAT.POL.H.205(b)(4) Take-off**

## THE APPLICATION OF TODRH

The selected height should be determined with the use of AFM data, and be at least 10.7 m (35 ft) above:

- (a) the take-off surface; or
- (b) as an alternative, a level height defined by the highest obstacle in the take-off distance required.

**GM1 CAT.POL.H.205(b)(4) Take-off**

## THE APPLICATION OF TODRH

## (a) Introduction

Original definitions for helicopter performance were derived from aeroplanes; hence, the definition of take-off distance owes much to operations from runways. Helicopters on the other hand can operate from runways, confined and restricted areas and rooftop FATOs — all bounded by obstacles. As an analogy, this is equivalent to a take-off from a runway with obstacles on and surrounding it.

It can, therefore, be said that unless the original definitions from aeroplanes are tailored for helicopters, the flexibility of the helicopter might be constrained by the language of operational performance.

This GM concentrates on the critical term ‘take-off distance required (TODRH)’ and describes the methods to achieve compliance with it and, in particular, the alternative procedure described in ICAO Annex 6 Attachment A 4.1.1.3:

- (1) the take-off distance required does not exceed the take-off distance available; or
  - (2) as an alternative, the take-off distance required may be disregarded provided that the helicopter with the critical engine failure recognised at TDP can, when continuing the take-off, clear all obstacles between the end of the take-off distance available and the point at which it becomes established in a climb at VTOSS by a vertical margin of 10.7 m (35 ft) or more. An obstacle is considered to be in the path of the helicopter if its distance from the nearest point on the surface below the intended line of flight does not exceed 30 m or 1.5 times the maximum dimension of the helicopter, whichever is greater.
- (b) Definition of TODRH

The definition of TODRH from Annex I is as follows:

‘Take-off distance required (TODRH)’ in the case of helicopters means the horizontal distance required from the start of the take-off to the point at which take-off safety speed (VTOSS), a selected height and a positive climb gradient are achieved, following failure of the critical engine being recognised at the TDP, the remaining engines operating within approved operating limits.

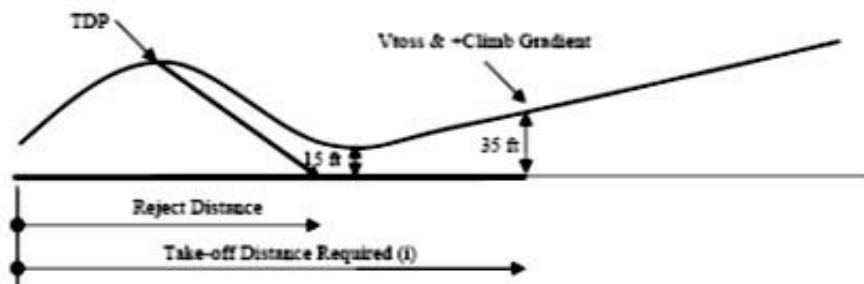
AMC1 CAT.POL.H.205(b)(4) states how the specified height should be determined. The original definition of TODRH was based only on the first part of this definition.

## (c) The clear area procedure (runway)

In the past, helicopters certified in Category A would have had, at the least, a ‘clear area’ procedure. This procedure is analogous to an aeroplane Category A procedure and assumes a runway (either metalled or grass) with a smooth surface suitable for an aeroplane take-off (see Figure 1).

The helicopter is assumed to accelerate down the FATO (runway) outside of the height velocity (HV) diagram. If the helicopter has an engine failure before TDP, it must be able to land back on the FATO (runway) without damage to helicopter or passengers; if there is a failure at or after TDP the aircraft is permitted to lose height — providing it does not descend below a specified height above the surface (usually 15 ft if the TDP is above 15 ft). Errors by the pilot are taken into consideration, but the smooth surface of the FATO limits serious damage if the error margin is eroded (e.g. by a change of wind conditions).

**Figure 1:** Clear Area take – off



The operator only has to establish that the distances required are within the distance available (take-off distance and reject distance). The original definition of TODRH meets this case exactly.

From the end of the TODRH obstacle clearance is given by the climb gradient of the first or second climb segment meeting the requirement of CAT.POL.H.210 (or for performance class 2 (PC2): CAT.POL.H.315). The clearance margin from obstacles in the take-off flight path takes account of the distance travelled from the end of the take-off distance required and operational conditions (IMC or VMC).

(d) Category A procedures other-than-clear area

Procedures other-than-the-clear areas are treated somewhat differently. However, the short field procedure is somewhat of a hybrid as either (a) or (b) of AMC1 CAT.POL.H.205(b)(4) can be utilised (the term 'helipad' is used in the following section to illustrate the principle only, it is not intended as a replacement for 'aerodrome' or 'FATO').

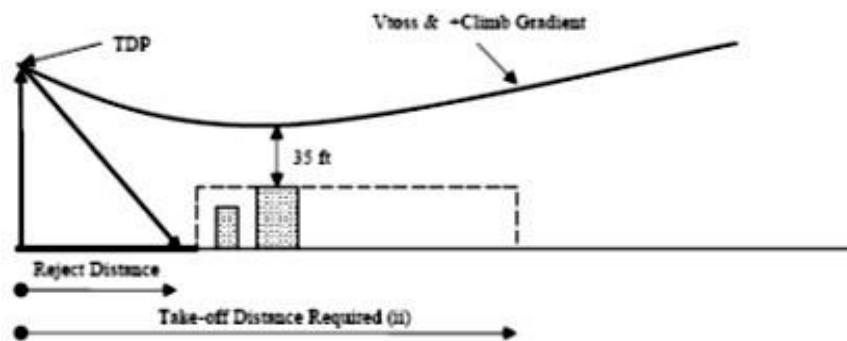
(1) Limited area, restricted area and helipad procedures (other than elevated)

The exact names of the procedure used for other-than-clear area are as many as there are manufacturers. However, principles for obstacle clearance are generic and the name is unimportant.

These procedures (see Figure 2 and Figure 3) are usually associated with an obstacle in the continued take-off area — usually shown as a line of trees or some other natural obstacle. As clearance above such obstacles is not readily associated with an accelerative procedure, as described in (c), a procedure using a vertical climb (or a steep climb in the forward, sideways or rearward direction) is utilised.

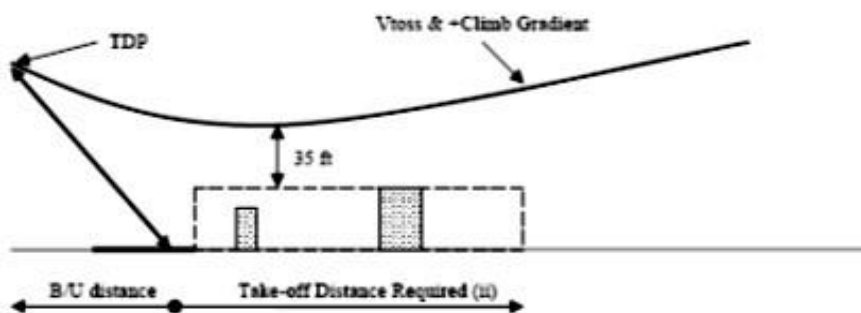


Figure 2: Short Field take- off



With the added complication of a TDP principally defined by height together with obstacles in the continued take off area, a drop down to within 15 ft of the take-off surface is not deemed appropriate and the required obstacle clearance is set to 35 ft (usually called 'min- dip'). The distance to the obstacle does not need to be calculated (provided it is outside the rejected distance required), as clearance above all obstacles is provided by ensuring that helicopter does not descend below the min-dip associated with a level defined by the highest obstacle in the continued take-off area.

Figure 3: Helipad take-off



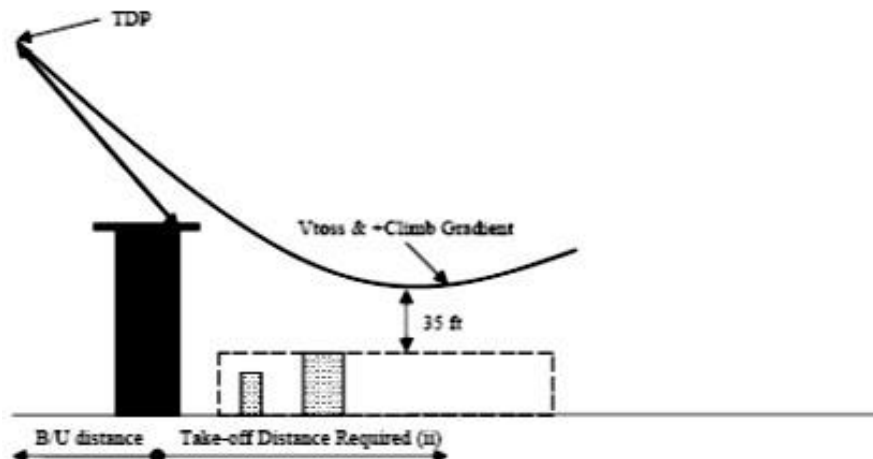
These procedures depend upon (b) of AMC1 CAT.POL.H.205(b)(4).

As shown in Figure 3, the point at which VTOSS and a positive rate of climb are met defines the TODRH. Obstacle clearance from that point is assured by meeting the requirement of CAT.POL.H.210 (or for PC2, CAT.POL.H.315). Also shown in Figure 3 is the distance behind the helipad which is the backup distance (B/U distance).

## (2) Elevated helipad procedures

The elevated helipad procedure (see Figure 4) is a special case of the ground level helipad procedure discussed above.

Figure 4: Elevate Helipad take-off



The main difference is that drop down below the level of the take-off surface is permitted. In the drop down phase, the Category A procedure ensures deck-edge clearance but, once clear of the deck-edge, the 35 ft clearance from obstacles relies upon the calculation of drop down. Subparagraph (b) of AMC1 CAT.POL.H.205(b)(4) is applied.

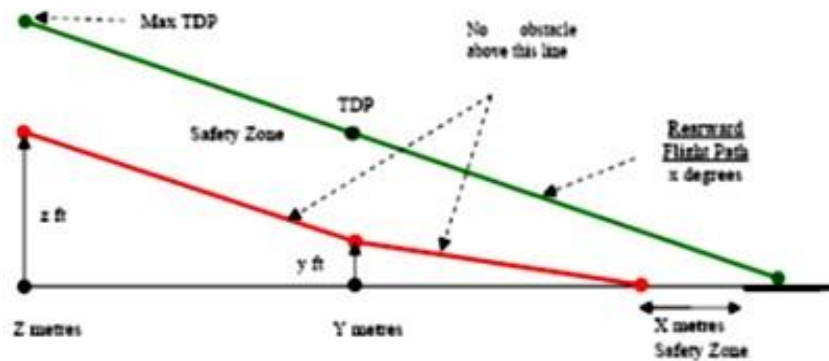
Although 35 ft is used throughout the requirements, it may be inadequate at particular elevated FATOs that are subject to adverse airflow effects, turbulence, etc.

### AMC1 CAT.POL.H.205(e) Take-off

#### OBSTACLE CLEARANCE IN THE BACKUP AREA

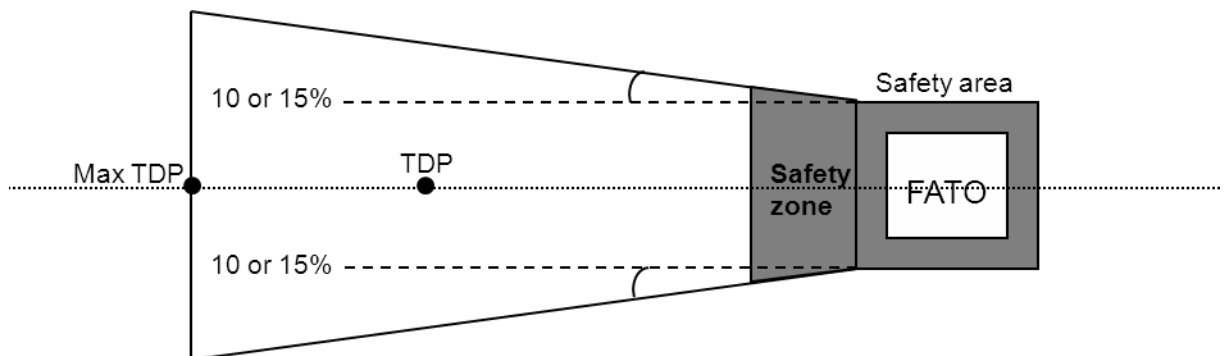
- (a) The requirement in CAT.POL.H.205(e) has been established in order to take into account the following factors:
  - (1) in the backup: the pilot has few visual cues and has to rely upon the altimeter and sight picture through the front window (if flight path guidance is not provided) to achieve an accurate rearward flight path;
  - (2) in the rejected take-off: the pilot has to be able to manage the descent against a varying forward speed whilst still ensuring an adequate clearance from obstacles until the helicopter gets in close proximity for landing on the FATO; and
  - (3) in the continued take-off; the pilot has to be able to accelerate to VTOSS (take-off safety speed for Category A helicopters) whilst ensuring an adequate clearance from obstacles.
- (b) The requirements of CAT.POL.H.205(e) may be achieved by establishing that:
  - (1) in the backup area no obstacles are located within the safety zone below the rearward flight path when described in the AFM (see Figure 1, in the absence of such data in the AFM, the operator should contact the manufacturer in order to define a safety zone); or
  - (2) during the backup, the rejected take-off and the continued take-off manoeuvres, obstacle clearance is demonstrated to the competent authority.

Figure 1: Rearward flight path



- (c) An obstacle, in the backup area, is considered if its lateral distance from the nearest point on the surface below the intended flight path is not further than:
- (1) half of the minimum FATO (or the equivalent term used in the AFM) width defined in the AFM (or, when no width is defined  $0.75 D$ , where  $D$  is the largest dimension of the helicopter when the rotors are turning); plus
  - (2)  $0.25$  times  $D$  (or  $3$  m, whichever is greater); plus
  - (3)  $0.10$  for VFR day, or  $0.15$  for VFR night, of the distance travelled from the back of the FATO (see Figure 2).

Figure 2: Obstacle accountability



## AMC1 CAT.POL.H.205 & CAT.POL.H.220 Take-off and landing

### APPLICATION FOR ALTERNATIVE TAKE-OFF AND LANDING PROCEDURES

- (a) A reduction in the size of the take-off surface may be applied when the operator has demonstrated to the competent authority that compliance with the requirements of CAT.POL.H.205, 210 and 220 can be assured with:
- (1) a procedure based upon an appropriate Category A take-off and landing profile scheduled in the AFM;
  - (2) a take-off or landing mass not exceeding the mass scheduled in the AFM for a hover-out-of-ground-effect one-engine-inoperative (HOGE OEI) ensuring that:
    - (i) following an engine failure at or before TDP, there are adequate external references to ensure that the helicopter can be landed in a controlled manner; and

- (ii) following an engine failure at or after the landing decision point (LDP), there are adequate external references to ensure that the helicopter can be landed in a controlled manner.
- (b) An upwards shift of the TDP and LDP may be applied when the operator has demonstrated to the competent authority that compliance with the requirements of CAT.POL.H.205, 210 and 220 can be assured with:
  - (1) a procedure based upon an appropriate Category A take-off and landing profile scheduled in the AFM;
  - (2) a take-off or landing mass not exceeding the mass scheduled in the AFM for a HOGE OEI ensuring that:
    - (i) following an engine failure at or after TDP compliance with the obstacle clearance requirements of CAT.POL.H.205 (b)(4) and CAT.POL.H.210 can be met; and
    - (ii) following an engine failure at or before the LDP the balked landing obstacle clearance requirements of CAT.POL.H.220 (b) and CAT.POL.H.210 can be met.
- (c) The Category A ground level surface area requirement may be applied at a specific elevated FATO when the operator can demonstrate to the competent authority that the usable cue environment at that aerodrome/operating site would permit such a reduction in size.

## **GM1 CAT.POL.H.205&CAT.POL.H.220 Take-off and landing**

### **APPLICATION FOR ALTERNATIVE TAKE-OFF AND LANDING PROCEDURES**

The manufacturer's Category A procedure defines profiles and scheduled data for take-off, climb, performance at minimum operating speed and landing, under specific environmental conditions and masses.

Associated with these profiles and conditions are minimum operating surfaces, take-off distances, climb performance and landing distances; these are provided (usually in graphic form) with the take-off and landing masses and the take-off decision point (TDP) and landing decision point (LDP).

The landing surface and the height of the TDP are directly related to the ability of the helicopter — following an engine failure before or at TDP — to reject onto the surface under forced landing conditions. The main considerations in establishing the minimum size of the landing surface are the scatter during flight testing of the reject manoeuvre, with the remaining engine operating within approved limits, and the required usable cue environment.

Hence, an elevated site with few visual cues — apart from the surface itself — would require a greater surface area in order that the helicopter can be accurately positioned during the reject manoeuvre within the specified area. This usually results in the stipulation of a larger surface for an elevated site than for a ground level site (where lateral cues may be present).

This could have the unfortunate side effect that a FATO that is built 3 m above the surface (and, therefore, elevated by definition) might be out of operational scope for some helicopters — even though there might be a rich visual cue environment where rejects are not problematical. The presence of elevated sites where ground level surface requirements might be more appropriate could be brought to the attention of the competent authority.

It can be seen that the size of the surface is directly related to the requirement of the helicopter to complete a rejected take-off following an engine failure. If the helicopter has sufficient power such that a failure before or at TDP will not lead to a requirement for rejected take-off, the need for large surfaces is removed; sufficient power for the purpose of this GM is considered to be the power required for hover-out-of-ground-effect one-engine-inoperative (HOGE OEI).

Following an engine failure at or after the TDP, the continued take-off path provides OEI clearance from the take-off surface and the distance to reach a point from where climb performance in the first, and subsequent segments, is assured.

If HOGE OEI performance exists at the height of the TDP, it follows that the continued take-off profile, which has been defined for a helicopter with a mass such that a rejected take-off would be required following an engine failure at or before TDP, would provide the same, or better, obstacle clearance and the same, or less, distance to reach a point where climb performance in the first, and subsequent segments, is assured.

If the TDP is shifted upwards, provided that the HOGE OEI performance is established at the revised TDP, it will not affect the shape of the continued take-off profile but should shift the min-dip upwards by the same amount that the revised TDP has been increased — with respect to the basic TDP.

Such assertions are concerned only with the vertical or the backup procedures and can be regarded as achievable under the following circumstances:

- (a) when the procedure is flown, it is based upon a profile contained in the AFM — with the exception of the necessity to perform a rejected take-off;
- (b) the TDP, if shifted upwards (or upwards and backward in the backup procedure) will be the height at which the HOGE OEI performance is established; and
- (c) if obstacles are permitted in the backup area, they should continue to be permitted with a revised TDP.

### **GM1 CAT.POL.H.215(b)(3) En-route — critical engine inoperative**

#### FUEL JETTISON

The presence of obstacles along the en-route flight path may preclude compliance with CAT.POL.H.215 (a)(1) at the planned mass at the critical point along the route. In this case fuel jettison at the most critical point may be planned, provided that the procedures of (c) in AMC3 CAT.OP.MPA.150(b) are complied with.

### **AMC1 CAT.POL.H.225(a)(5) Helicopter operations to/from a public interest site**

#### HELICOPTER MASS LIMITATION

- (a) The helicopter mass limitation at take-off or landing specified in CAT.POL.H.225(a)(5) should be determined using the climb performance data from 35 ft to 200 ft at VTOSS (first segment of the take-off flight path) contained in the Category A supplement of the AFM (or equivalent manufacturer data acceptable in accordance with GM1- CAT.POL.H.200 & CAT.POL.H.300 & CAT.POL.H.400).
- (b) The first segment climb data to be considered is established for a climb at the take-off safety speed VTOSS, with the landing gear extended (when the landing gear is retractable), with the critical engine inoperative and the remaining engines operating at an appropriate power rating (the 2 min 30 sec or 2 min OEI power rating, depending on the helicopter type certification). The appropriate VTOSS, is the value specified in the Category A performance section of the AFM for vertical take-off and landing procedures (VTOL, helipad or equivalent manufacturer terminology).
- (c) The ambient conditions at the site (pressure-altitude and temperature) should be taken into account.
- (d) The data are usually provided in charts in one of the following ways:

- (1) Height gain in ft over a horizontal distance of 100 ft in the first segment configuration (35 ft to 200 ft, VTOSS, 2 min 30 sec/2 min OEI power rating). This chart should be entered with a height gain of 8 ft per 100 ft horizontally travelled, resulting in a mass value for every pressure-altitude/temperature combination considered.
- (2) Horizontal distance to climb from 35 ft to 200 ft in the first segment configuration (VTOSS, 2 min 30 sec/2 min OEI power rating). This chart should be entered with a horizontally distance of 628 m (2 062 ft), resulting in a mass value for every pressure-altitude/temperature combination considered.
- (3) Rate of climb in the first segment configuration (35 ft to 200 ft, VTOSS, 2 min 30 sec/2 min OEI power rating). This chart can be entered with a rate of climb equal to the climb speed (VTOSS) value in knots (converted to true airspeed) multiplied by 8.1, resulting in a mass value for every pressure-altitude/temperature combination considered.

## **GM1 CAT.POL.H.225 Helicopter operations to/from a public interest site**

### UNDERLYING PRINCIPLES

#### (a) General

approval would be confined to those sites where a CAT A procedure alone cannot solve the problem. The determination of whether the helicopter can or cannot be operated in accordance with performance class 1 should be established with the helicopter at a realistic payload and fuel to complete the mission. However, in order to reduce the risk at those sites, the application of the requirements contained in CAT.POL.H.225(a) should be applied.

Additionally and in order to promote understanding of the problem, the text contained in CAT.POL.H.225(c) refers to the performance class and not to ICAO Annex 14. Thus, Part C of the operations manual should reflect the non-conformance with performance class 1, as well as the site-specific procedures (approach and departure paths) to minimise the danger to third parties in the event of an incident.

The following paragraphs explain the problem and solutions. (c) The problem associated with such sites

There is a number of problems: some of which can be solved with the use of appropriate helicopters and procedures; and others which, because of the size of the site or the obstacle environment, cannot. They consist of:

- (1) the size of the surface of the site (smaller than that required by the manufacturer's procedure);
  - (2) an obstacle environment that prevents the use of the manufacturer's procedure (obstacles in the backup area); and
  - (3) an obstacle environment that does not allow recovery following an engine failure in the critical phase of take-off (a line of buildings requiring a demanding gradient of climb) at a realistic payload and fuel to complete the mission.
- Problems associated with (c)(1): the inability to climb and conduct a rejected landing back to the site following an engine failure before the Decision Point (DP).
  - Problems associated with (c)(2): as in (c)(1)).
  - Problems associated with (c)(3): climb into an obstacle following an engine failure after DP.

Problems cannot be solved in the immediate future, but can, when mitigated with the use of the latest generation of helicopters (operated at a weight that can allow useful payloads and endurance), minimise exposure to risk.

(b) Long-term solution

Although not offering a complete solution, it was felt that a significant increase in safety could be achieved by applying an additional performance margin to such operations. This solution allowed the time restriction of 2004 to be removed.

The required performance level of 8 % climb gradient in the first segment reflects ICAO Annex 14 Volume II in 'Table 4- 3 'Dimensions and slopes of obstacle limitations surfaces' for performance class 2.

The performance delta is achieved without the provision of further manufacturer's data by using existing graphs to provide the reduced take-off mass (RTOM).

If the solution in relation to the original problem is examined, the effects can be seen.

- (1) Solution with relation to (c)(1): although the problem still exists, the safest procedure is a dynamic take-off reducing the time taken to achieve V<sub>stayup</sub> and thus allowing VFR recovery — if the failure occurs at or after V<sub>y</sub> and 200 ft, an IFR recovery is possible.
- (2) Solution with relation to (c)(2): as in (c)(1) above.
- (3) Solution with relation to (c)(3): once again this does not give a complete solution, however, the performance delta minimises the time during which a climb over the obstacle cannot be achieved.

### **GM1 CAT.POL.H.225(a)(6) Helicopter operations to/from a public interest site**

#### ENDORSEMENT FROM ANOTHER STATE

(a) Application to another State

To obtain an endorsement from another State, the operator should submit to that State:

- (1) the reasons that preclude compliance with the requirements for operations in performance class 1;
- (2) the site- specific procedures to minimise the period during which there would be danger to helicopter occupants and person on the surface in the event of an engine failure during take-off and landing; and
- (3) the extract from the operations manual to comply with CAT.POL.H.225(c).

(b) Endorsement from another State

Upon receiving the endorsement from another State, the operator should submit it together with the site-specific procedures and the reasons and justification that preclude the use of performance class 1 criteria to the competent authority issuing the AOC to obtain the approval or extend the approval to a new public interest site.

## Chapter 3 — Performance class 2

### GM to Section 2, Chapter 3 performance class 2

#### OPERATIONS IN PERFORMANCE CLASS 2

(a) Introduction

This GM describes performance class 2 as established in Part-CAT. It has been produced for the purpose of:

- (1) explaining the underlying philosophy of operations in performance class 2;
- (2) showing simple means of compliance; and
- (3) explaining how to determine — with examples and diagrams:
  - (i) the take-off and landing masses;
  - (ii) the length of the safe forced landing area;
  - (iii) distances to establish obstacle clearance; and
  - (iv) entry point(s) into performance class 1.

It explains the derivation of performance class 2 from ICAO Annex 6 Part III and describes an alleviation that may be approved in accordance with CAT.POL.H.305 following a risk assessment.

It examines the basic requirements, discusses the limits of operation, and considers the benefits of the use of performance class 2.

It contains examples of performance class 2 in specific circumstances, and explains how these examples may be generalised to provide operators with methods of calculating landing distances and obstacle clearance.

(b) Definitions used in this GM

The definitions for the following terms, used in this GM, are contained in Annex I and its AMC:

- (1) distance DR;
- (2) defined point after take-off (DPATO);
- (3) defined point before landing (DPBL);
- (4) landing distance available (LDAH);
- (5) landing distance required (LDRH);
- (6) performance class 2;
- (7) safe forced landing (SFL); and
- (8) take-off distance available (TODAH).

The following terms, which are not defined Annex I, are used in this GM:

- VT : a target speed at which to aim at the point of minimum ground clearance (min-dip) during acceleration from TDP to VTOSS;
- V50. : a target speed and height utilised to establish an AFM distance (in compliance with the requirement of CS/JAR 29.63) from which climb out is possible; and
- Vstayup : a colloquial term used to indicate a speed at which a descent would not result following an engine failure. This speed is several knots lower than VTOSS at the equivalent take-off mass.

(c) What defines performance class 2

Performance class 2 can be considered as performance class 3 take-off or landing, and performance class 1 climb, cruise and descent. It comprises an all-engines-operating (AEO) obstacle clearance regime for the take-off or landing



phases, and a OEI obstacle clearance regime for the climb, cruise, descent, approach and missed approach phases.

For the purpose of performance calculations in Part- CAT, the CS/JAR 29.67 Category A climb performance criteria is used:

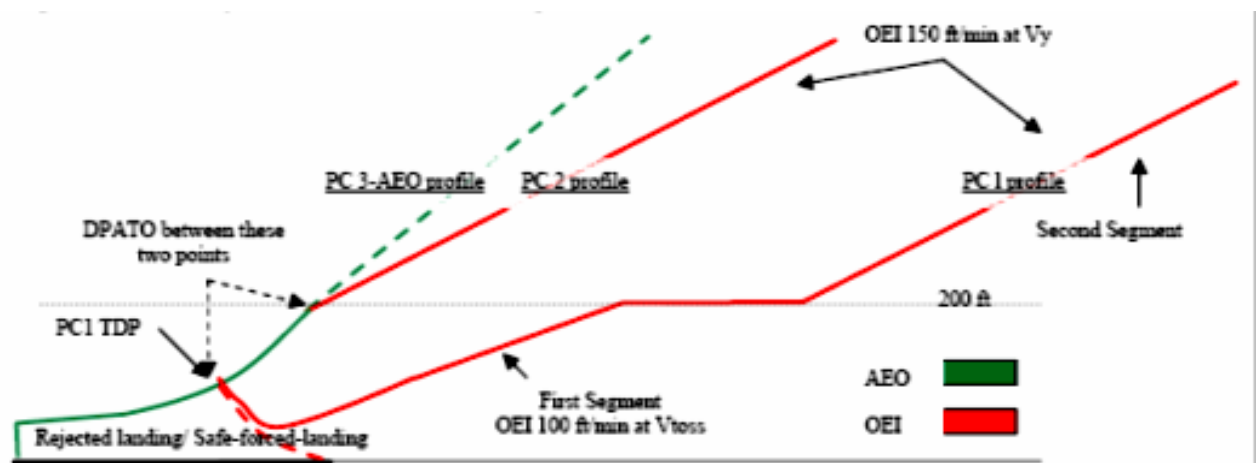
- 150 ft/min at 1 000 ft (at  $V_y$ ); and depending on the choice of DPATO:
- 100 ft/min up to 200 ft (at  $V_{TOSS}$ ) at the appropriate power settings.

(1) Comparison of obstacle clearance in all performance classes

Figure 1 shows the profiles of the three performance classes — superimposed on one diagram.

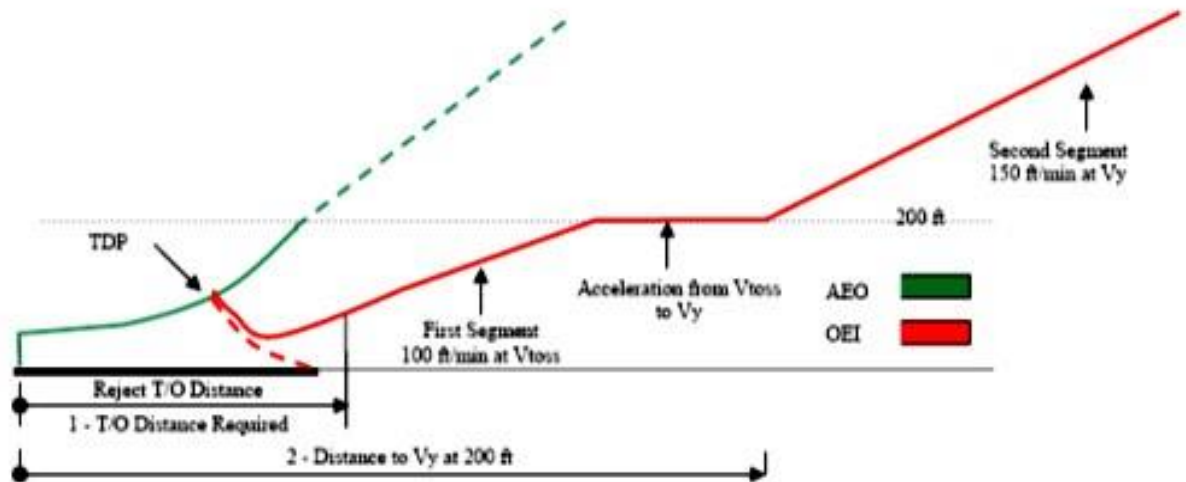
- Performance class 1 (PC1): from TDP, requires OEI obstacle clearance in all phases of flight; the construction of Category A procedures, provides for a flight path to the first climb segment, a level acceleration segment to  $V_y$  (which may be shown concurrent with the first segment), followed by the second climb segment from  $V_y$  at 200 ft (see Figure 1).

**Figure 1:** All Performance Classes (a comparison)



- Performance class 2 (PC2): requires AEO obstacle clearance to DPATO and OEI from then on. The take-off mass has the PC1 second segment climb performance at its basis therefore, at the point where  $V_y$  at 200 ft is reached, Performance Class 1 is achieved (see also Figure 3).
- Performance class 3 (PC3): requires AEO obstacle clearance in all phases.

Figure 2: Performance Class 1 distances



- (2) Comparison of the discontinued take-off in all performance classes
- (i) PC1 — requires a prepared surface on which a rejected landing can be undertaken (no damage); and
  - (ii) PC2 and 3 — require a safe forced landing surface (some damage can be tolerated, but there must be a reasonable expectancy of no injuries to persons in the aircraft or third parties on the surface).
- (d) The derivation of performance class 2
- PC2 is primarily based on the text of ICAO Annex 6 Part III Section II and its attachments which provide for the following:
- (1) obstacle clearance before DPATO: the helicopter shall be able, with all engines operating, to clear all obstacles by an adequate margin until it is in a position to comply with (2);
  - (2) obstacle clearance after DPATO: the helicopter shall be able, in the event of the critical engine becoming inoperative at any time after reaching DPATO, to continue the take-off clearing all obstacles along the flight path by an adequate margin until it is able to comply with en- route clearances; and
  - (3) engine failure before DPATO: before the DPATO, failure of the critical engine may cause the helicopter to force land; therefore, a safe forced landing should be possible (this is analogous to the requirement for a reject in performance class 1, but where some damage to the helicopter can be tolerated.)
- (e) Benefits of performance class 2
- Operations in performance class 2 permit advantage to be taken of an AEO procedure for a short period during take-off and landing — whilst retaining engine failure accountability in the climb, descent and cruise. The benefits include the ability to:
- (1) use (the reduced) distances scheduled for the AEO — thus permitting operations to take place at smaller aerodromes and allowing airspace requirements to be reduced;
  - (2) operate when the safe forced landing distance available is located outside the boundary of the aerodrome;
  - (3) operate when the take-off distance required is located outside the boundary of the aerodrome; and

- (4) use existing Category A profiles and distances when the surface conditions are not adequate for a reject, but are suitable for a safe forced landing (for example, when the ground is waterlogged).

Additionally, following a risk assessment when the use of exposure is approved by the competent authority the ability to:

- (i) operate when a safe forced landing is not assured in the take-off phase; and
  - (ii) penetrate the HV curve for short periods during take-off or landing.
- (f) Implementation of performance class 2 in Part-CAT

The following sections explain the principles of the implementation of performance class 2.

- (1) Does ICAO spell it all out?

ICAO Annex 6 does not give guidance on how DPATO should be calculated nor does it require that distances be established for the take-off. However, it does require that, up to DPATO AEO, and from DPATO OEI, obstacle clearance is established (see Figure 3 and Figure 4 which are simplified versions of the diagrams contained in Annex 6 Part III, Attachment A).

(ICAO Annex 8 – Airworthiness of Aircraft (IVA 2.2.3.1.4' and 'IVB 2.2.7 d) requires that an AEO distance be scheduled for all helicopters operating in performance classes 2 & 3. ICAO Annex 6 is dependent upon the scheduling of the AEO distances, required in Annex 8, to provide data for the location of DPATO.)

When showing obstacle clearance, the divergent obstacle clearance height required for IFR is — as in performance class 1 — achieved by the application of the additional obstacle clearance of 0.01 distance DR (the distance from the end of 'take-off-distance-available' — see the pictorial representation in Figure 4 and the definition in Annex I).

As can also be seen from Figure 4, flight must be conducted in VFR until DPATO has been achieved (and deduced that if an engine failure occurs before DPATO, entry into IFR is not permitted (as the OEI climb gradient will not have been established)).

Figure 3: Performance Class 2 Obstacle Clearance

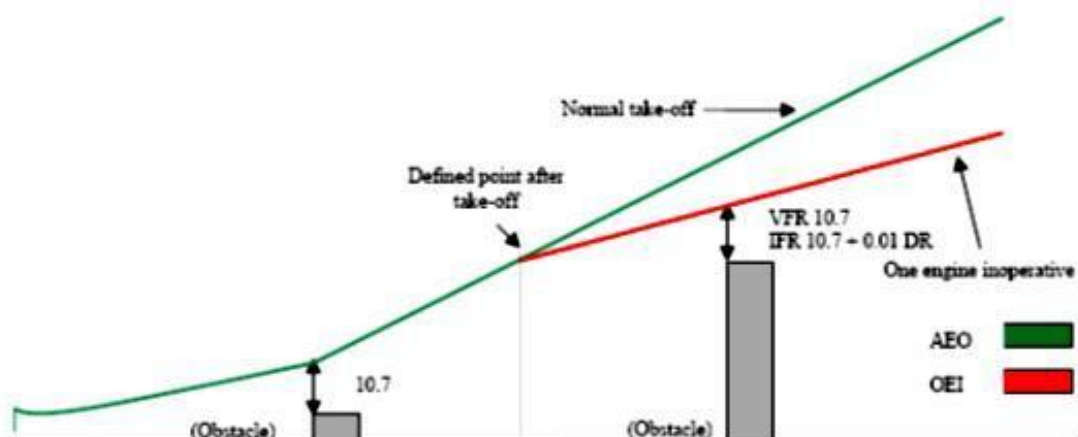
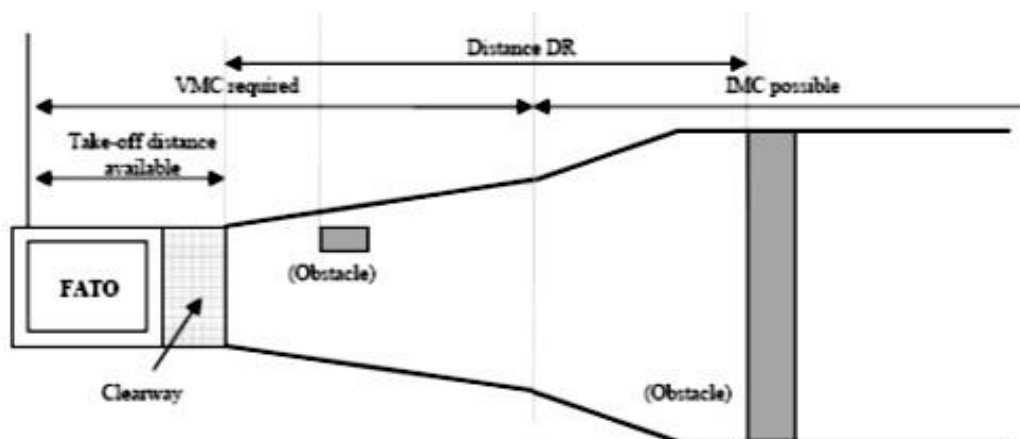


Figure 4: Performance Class 2 Obstacle Clearance (plan view)



## (2) Function of DPATO

From the preceding paragraphs, it can be seen that DPATO is germane to PC2. It can also be seen that, in view of the many aspects of DPATO, it has, potentially, to satisfy a number of requirements that are not necessarily synchronised (nor need to be).

It is clear that it is only possible to establish a single point for DPATO, satisfying the requirement of (d)(2) & (d)(3), when:

- accepting the TDP of a Category A procedure; or
- extending the safe forced landing requirement beyond required distances (if data are available to permit the calculation of the distance for a safe forced landing from the DPATO).

It could be argued that the essential requirement for DPATO is contained in section (d)(2) — OEI obstacle clearance. From careful examination of the flight path reproduced in Figure 3 above, it may be reasonably deduced that DPATO is the point at which adequate climb performance is established (examination of Category A procedures would indicate that this could be (in terms of mass, speed and height above the take-off surface) the conditions at the start of the first or second segments — or any point between.)

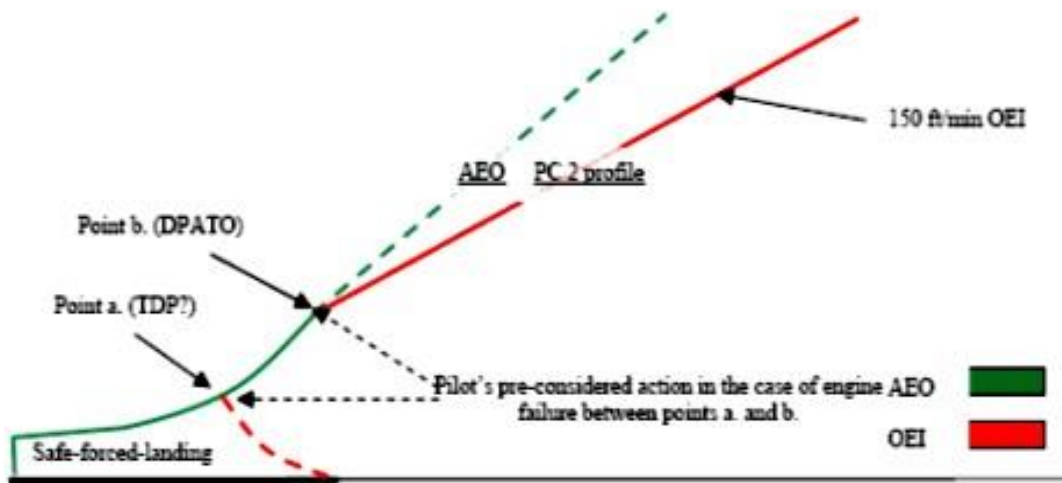
(The diagrams in Attachment A of ICAO Annex 6 do not appear to take account of drop down — permitted under Category A procedures; similarly with helideck departures, the potential for acceleration in drop down below deck level (once the deck edge has been cleared) is also not shown. These omissions could be regarded as a simplification of the diagram, as drop down is discussed and accepted in the accompanying ICAO text.)

It may reasonably be argued that, during the take-off and before reaching an appropriate climb speed ( $V_{TOSS}$  or  $V_y$ ),  $V_{stayup}$  will already have been achieved (where  $V_{stayup}$  is the ability to continue the flight and accelerate without descent — shown in some Category A procedures as  $V_T$  or target speed) and where, in the event of an engine failure, no landing would be required.

It is postulated that, to practically satisfy all the requirements of (d)(1), (2) and (3), DPATO does not need to be defined at one synchronised point; provisions can be met separately, i.e. defining the distance for a safe forced landing, and then establishing the OEI obstacle clearance flight path.

As the point at which the helicopter's ability to continue the flight safely, with the critical engine inoperative is the critical element, it is that for which DPATO is used in this text.

Figure 5: The three elements in a PC 2 take-off



## (i) The three elements from the pilot's perspective

When seen from the pilot's perspective (see Figure 5), there are three elements of the PC 2 take-off — each with associated related actions which need to be considered in the case of an engine failure:

- (A) action in the event of an engine failure — up to the point where a forced-landing will be required;
- (B) action in the event of an engine failure — from the point where OEI obstacle clearance is established (DPATO); and
- (C) pre-considered action in the event of an engine failure — in the period between (A) and (B)

The action of the pilot in (A) and (B) is deterministic, i.e. it remains the same for every occasion. For pre-consideration of the action at point (C), as is likely that the planned flight path will have to be abandoned (the point at which obstacle clearance using the OEI climb gradients not yet being reached), the pilot must (before take-off) have considered his/her options and the associated risks, and have in mind the course of action that will be pursued in the event of an engine failure during that short period. (As it is likely that any action will involve turning manoeuvres, the effect of turns on performance must be considered.)

## (3) Take-off mass for performance class 2

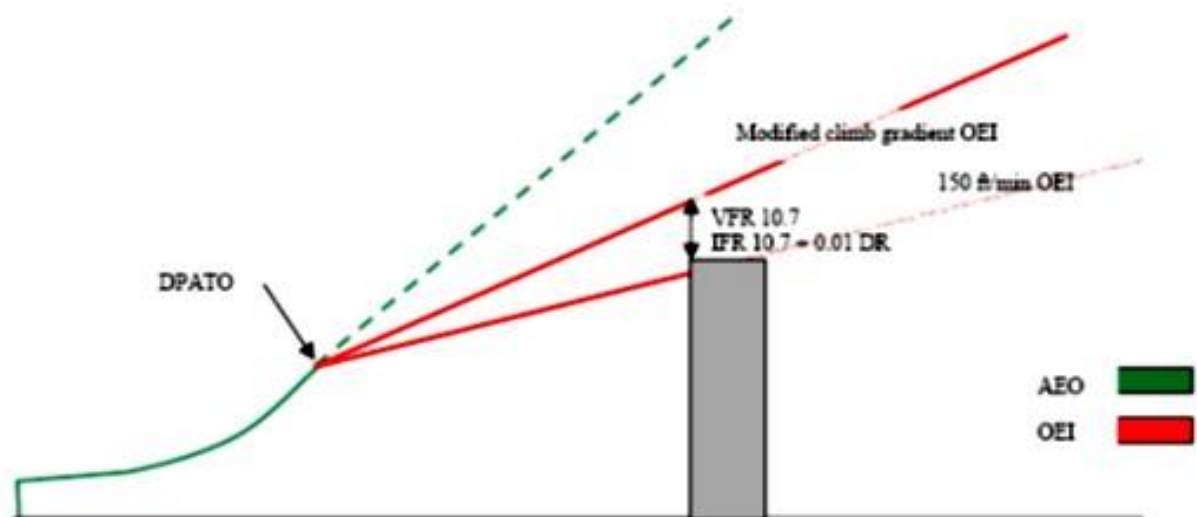
As previously stated, performance class 2 is an AEO take-off that, from DPATO, has to meet the requirement for OEI obstacle clearance in the climb and en-route phases. Take-off mass is, therefore, the mass that gives at least the minimum climb performance of 150 ft/min at  $V_y$ , at 1 000 ft above the take-off point, and obstacle clearance.

As can be seen in Figure 6 below, the take-off mass may have to be modified when it does not provide the required OEI clearance from obstacles in the take-off-flight path (exactly as in performance class 1). This could occur when taking off from an aerodrome/operating site where the flight path has to clear an obstacle such a ridge line (or line of buildings) that can neither be:

- (i) flown around using VFR and see and avoid; nor
- (ii) cleared using the minimum climb gradient given by the take-off mass (150 ft/min at 1 000 ft).

In this case, the take-off mass has to be modified (using data contained in the AFM) to give an appropriate climb gradient.

Figure 6: Performance Class 2 (enhanced climb gradient)



(4) Do distances have to be calculated?

Distances do not have to be calculated if, by using pilot judgement or standard practice, it can be established that:

- (i) a safe forced landing is possible following an engine failure (notwithstanding that there might be obstacles in the take-off path); and
- (ii) obstacles can be cleared (or avoided) — AEO in the take-off phase and OEI in the climb.

If early entry (in the sense of cloud base) into IMC is expected, an IFR departure should be planned. However, standard masses and departures can be used when described in the operations manual.

(5) The use of Category A data

In Category A procedures, TDP is the point at which either a rejected landing or a safe continuation of the flight, with OEI obstacle clearance, can be performed.

For PC2 (when using Category A data), only the safe forced landing (reject) distance depends on the equivalent of the TDP; if an engine fails between TDP and DPATO, the pilot has to decide what action is required. It is not necessary for a safe forced landing distance to be established from beyond the equivalent of TDP (see Figure 5 and discussion in (f)(2)(ii)(A)).

Category A procedures based on a fixed VTOSS are usually optimised either for the reduction of the rejected take-off distance, or the take-off distance.

Category A procedures based on a variable VTOSS allow either a reduction in required distances (low VTOSS) or an improvement in OEI climb capability (high VTOSS). These optimisations may be beneficial in PC2 to satisfy the dimensions of the take-off site.

In view of the different requirements for PC2 (from PC1), it is perfectly acceptable for the two calculations (one to establish the safe forced landing distance and the other to establish DPATO) to be based upon different Category A procedures. However, if this method is used, the mass resulting

from the calculation cannot be more than the mass from the more limiting of the procedures.

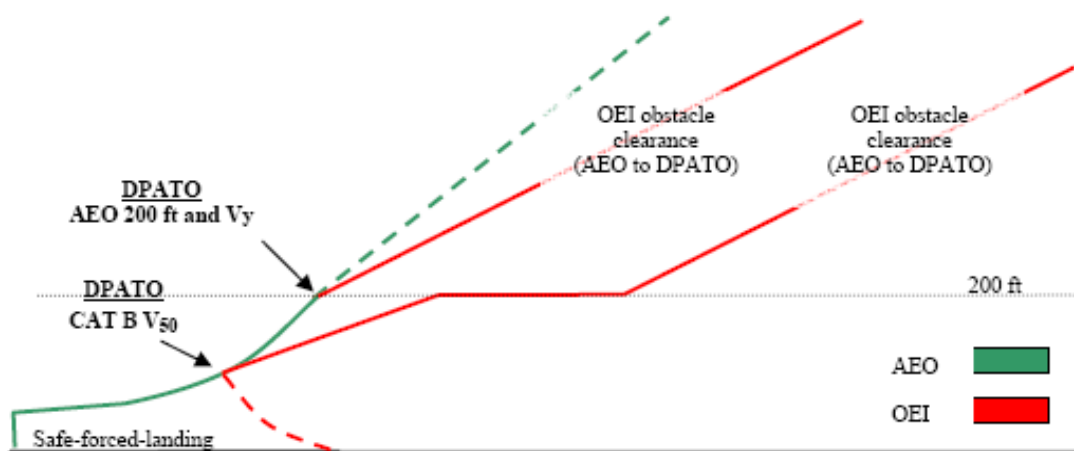
(6) DPATO and obstacle clearance

If it is necessary for OEI obstacle clearance to be established in the climb, the starting point (DPATO) for the (obstacle clearance) gradient has to be established. Once DPATO is defined, the OEI obstacle clearance is relatively easy to calculate with data from the AFM.

(i) DPATO based on AEO distance

In the simplest case; if provided, the scheduled AEO to 200 ft at  $V_y$  can be used (see Figure 7).

Figure 7: Suggested AEO locations for DPATO

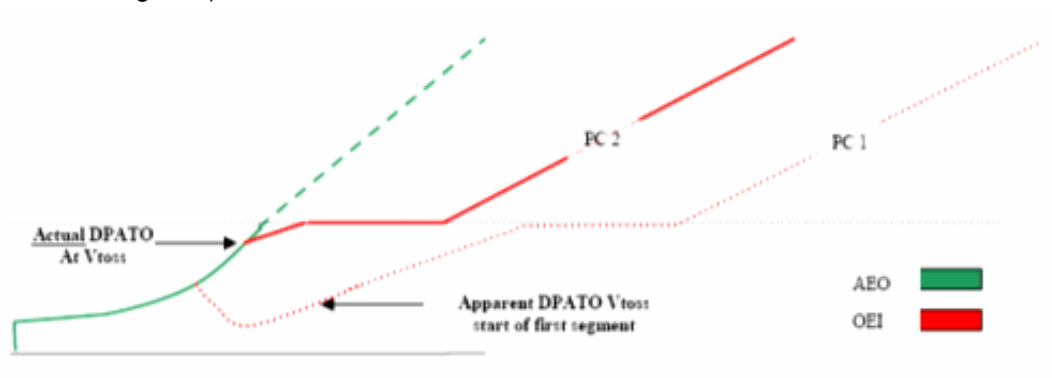


Otherwise, and if scheduled in the AFM, the AEO distance to 50 ft ( $V_{50}$ ) — determined in accordance with CS/JAR 29.63 — can be used (see Figure 7). Where this distance is used, it will be necessary to ensure that the  $V_{50}$  climb out speed is associated with a speed and mass for which OEI climb data are available so that, from  $V_{50}$ , the OEI flight path can be constructed.

(ii) DPATO based on Category A distances

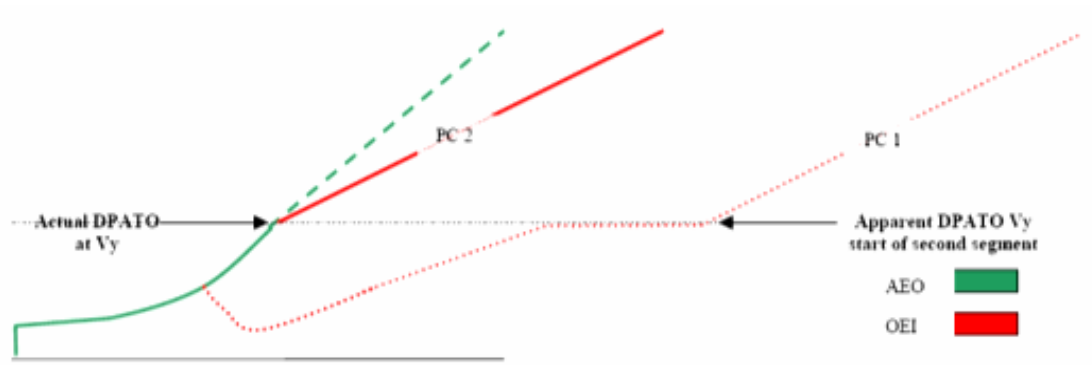
It is not necessary for specific AEO distances to be used (although for obvious reasons it is preferable); if they are not available, a flight path (with OEI obstacle clearance) can be established using Category A distances (see Figure 8 and Figure 9) — which will then be conservative.

Figure 8: Using Cat A data; actual and apparent position of DPATO ( $V_{\text{toss}}$  and start of first segment)



The apparent DPATO is for planning purposes only in the case where AEO data are not available to construct the take-off flight path. The actual OEI flight path will provide better obstacle clearance than the apparent one (used to demonstrate the minimum requirement) — as seen from the firm and dashed lines in the above figure.

Figure 9: Using Cat A data; actual and apparent position of DPATO ( $V_y$  and start of second segment)



(iii) Use of most favourable Category A data

The use of AEO data are recommended for calculating DPATO. However, where an AEO distance is not provided in the flight manual, distance to  $V_y$  at 200 ft, from the most favourable of the Category A procedures, can be used to construct a flight path (provided it can be demonstrated that AEO distance to 200 ft at  $V_y$  is always closer to the take-off point than the CAT A OEI flight path).

In order to satisfy the requirement of CAT.POL.H.315, the last point from where the start of OEI obstacle clearance can be shown is at 200 ft.

(7) The calculation of DPATO — a summary

DPATO should be defined in terms of speed and height above the take-off surface and should be selected such that AFM data (or equivalent data) are available to establish the distance from the start of the take-off up to the DPATO (conservatively if necessary).

(i) First method

DPATO is selected as the AFM Category B take-off distance ( $V_{50}$  speed or any other take-off distance scheduled in accordance with CS/JAR 29.63) provided that within the distance the helicopter can achieve:

- (A) one of the VTOSS values (or the unique VTOSS value if it is not variable) provided in the AFM, selected so as to assure a climb capability according to Category A criteria; or
- (B)  $V_y$ .

Compliance with CAT.POL.H.315 would be shown from  $V_{50}$  (or the scheduled Category B take-off distance).

(ii) Second method

DPATO is selected as equivalent to the TDP of a Category A 'clear area' take-off procedure conducted in the same conditions.

Compliance with CAT.POL.H.315 would be shown from the point at which VTOSS, a height of at least 35 ft above the take-off surface and a positive climb gradient are achieved (which is the Category A 'clear area' take-off distance).



Safe forced landing areas should be available from the start of the take-off, to a distance equal to the Category A 'clear area' rejected take-off distance.

(iii) Third method

As an alternative, DPATO could be selected such that AFM OEI data are available to establish a flight path initiated with a climb at that speed. This speed should then be:

- (A) one of the VTOSS values (or the unique VTOSS value if it is not variable) provided in the AFM, selected so as to assure a climb capability according to Category A criteria; or
- (B)  $V_y$

The height of the DPATO should be at least 35 ft and can be selected up to 200 ft. Compliance with CAT.POL.H.315 would be shown from the selected height.

(8) Safe forced landing distance

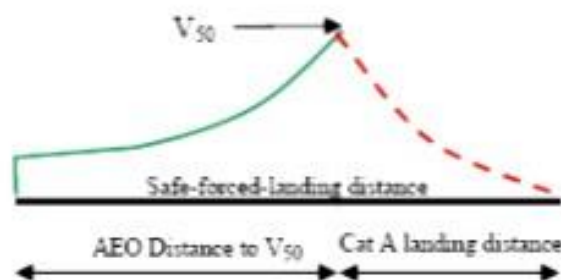
Except as provided in (f)(7)(ii), the establishment of the safe forced landing distance could be problematical as it is not likely that PC2 specific data will be available in the AFM.

By definition, the Category A reject distance may be used when the surface is not suitable for a reject, but may be satisfactory for a safe forced landing (for example, where the surface is flooded or is covered with vegetation).

Any Category A (or other accepted) data may be used to establish the distance. However, once established, it remains valid only if the Category A mass (or the mass from the accepted data) is used and the Category A (or accepted) AEO profile to the TDP is flown. In view of these constraints, the likeliest Category A procedures are the clear area or the short field (restricted area/site) procedures.

From Figure 10, it can be seen that if the Category B V50 procedure is used to establish DPATO, the combination of the distance to 50 ft and the Category A 'clear area' landing distance, required by CS/JAR 29.81 (the horizontal distance required to land and come to a complete stop from a point 50 ft above the landing surface), will give a good indication of the maximum safe- forced-landing distance required (see also the explanation on Vstayup above).

Figure 10: Category B (V50) safe–forced–landing distance



(9) Performance class 2 landing

For other than PC2 operations to elevated FATOs or helidecks (see section (g)(4)(i)), the principles for the landing case are much simpler. As the performance requirements for PC1 and PC2 landings are virtually identical, the condition of the landing surface is the main issue.

If the engine fails at any time during the approach, the helicopter must be able either: to perform a go-around meeting the requirements of CAT.POL.H.315; or perform a safe forced landing on the surface. In view of

this, and if using PC1 data, the LDP should not be lower than the corresponding TDP (particularly in the case of a variable TDP).

The landing mass will be identical to the take-off mass for the same site (with consideration for any reduction due to obstacle clearance — as shown in Figure 6 above).

In the case of a balked landing (i.e. the landing site becomes blocked or unavailable during the approach), the full requirement for take-off obstacle clearance must be met.

(g) Operations in performance class 2 with exposure

The Implementing Rules offer an opportunity to discount the requirement for an assured safe forced landing area in the take-off or landing phase — subject to an approval from the competent authority. The following sections deal with this option:

(1) Limit of exposure

As stated above, performance class 2 has to ensure AEO obstacle clearance to DPATO and OEI obstacle clearance from that point. This does not change with the application of exposure.

It can, therefore, be stated that operations with exposure are concerned only with alleviation from the requirement for the provision of a safe forced landing.

The absolute limit of exposure is 200 ft — from which point OEI obstacle clearance must be shown.

(2) The principle of risk assessment

ICAO Annex 6 Part III Chapter 3.1.2 states that:

‘3.1.2 In conditions where the safe continuation of flight is not ensured in the event of a critical engine failure, helicopter operations shall be conducted in a manner that gives appropriate consideration for achieving a safe forced landing.’

Although a safe forced landing may no longer be the (absolute) Standard, it is considered that risk assessment is obligatory to satisfy the amended requirement for ‘appropriate consideration’.

Risk assessment used for fulfilment of this proposed Standard is consistent with principles described in ‘AS/NZS 4360:1999’. Terms used in this text and defined in the AS/NZS Standard are shown in Sentence Case e.g. risk assessment or risk reduction.

(3) The application of risk assessment to performance class 2

Under circumstances where no risk attributable to engine failure (beyond that inherent in the safe forced landing) is present, operations in performance class 2 may be conducted in accordance with the non-alleviated requirements contained above — and a safe forced landing will be possible.

Under circumstances where such risk would be present, i.e. operations to an elevated FATO (deck edge strike); or, when permitted, operations from a site where a safe forced landing cannot be accomplished because the surface is inadequate; or where there is penetration into the HV curve for a short period during take-off or landing (a limitation in CS/JAR 29 AFMs), operations have to be conducted under a specific approval.

Provided such operations are risk assessed and can be conducted to an established safety target, they may be approved in accordance with CAT.POL.H.305.

(i) The elements of the risk management

The approval process consists of an operational risk assessment and the application of four principles:

- (A) a safety target;
- (B) a helicopter reliability assessment;
- (C) continuing airworthiness; and
- (D) mitigating procedures.

(ii) The safety target

The main element of the risk assessment when exposure was initially introduced, was the assumption that turbine engines in helicopters would have failure rates of about 1:100 000 per flying hour, which would permit (against the agreed safety target of  $5 \times 10^{-8}$  per event) an exposure of about 9 seconds for twins during the take-off or landing event. (When choosing this target it was assumed that the majority of current well-maintained turbine powered helicopters would be capable of meeting the event target — it, therefore, represents the residual risk).

(Residual risk is considered to be the risk that remains when all mitigating procedures — airworthiness and operational — are applied (see sections (g)(3)(iv) and (g)(3)(v))).

(iii) The reliability assessment

The reliability assessment was initiated to test the hypothesis (stated in (g)(3)(ii)) that the majority of turbine powered types would be able to meet the safety target. This hypothesis could only be confirmed by an examination of the manufacturers' power-loss data.

(iv) Mitigating procedures (airworthiness)

Mitigating procedures consist of a number of elements:

- (A) the fulfilment of all manufacturers' safety modifications;
- (B) a comprehensive reporting system (both failures and usage data); and
- (C) the implementation of a usage monitoring system (UMS).

Each of these elements is to ensure that engines, once shown to be sufficiently reliable to meet the safety target, will sustain such reliability (or improve upon it).

The monitoring system is felt to be particularly important as it had already been demonstrated that when such systems are in place it inculcates a more considered approach to operations. In addition, the elimination of 'hot starts', prevented by the UMS, itself minimises the incidents of turbine burst failures.

(v) Mitigating procedures (operations)

Operational and training procedures, to mitigate the risk — or minimise the consequences — are required of the operator. Such procedures are intended to minimise risk by ensuring that:

- (A) the helicopter is operated within the exposed region for the minimum time; and
- (B) simple but effective procedures are followed to minimise the consequence should an engine failure occur.

(4) Operation with exposure

When operating with exposure, there is alleviation from the requirement to establish a safe forced landing area (which extends to landing as well as take-off). However, the requirement for obstacle clearance — AEO in the take-off

and from DPATO OEI in the climb and en- route phases — remains (both for take- off and landing).

The take-off mass is obtained from the more limiting of the following:

- the climb performance of 150 ft/min at 1 000 ft above the take-off point; or
  - obstacle clearance (in accordance with (f)(3) above); or
  - AEO hover out of ground effect (HOGE) performance at the appropriate power setting. (AEO HOGE is required to ensure acceleration when (near) vertical dynamic take-off techniques are being used. Additionally, for elevated FATO or helidecks, it ensures a power reserve to offset ground cushion dissipation; and ensures that, during the landing manoeuvre, a stabilised HOGE is available — should it be required.)
- (i) Operations to elevated FATOs or helidecks
- PC2 operations to elevated FATOs and helidecks are a specific case of operations with exposure. In these operations, the alleviation covers the possibility of:
- (A) a deck-edge strike if the engine fails early in the take-off or late in the landing;
  - (B) penetration into the HV Curve during take- off and landing; and
  - (C) forced landing with obstacles on the surface (hostile water conditions) below the elevated FATO (helideck). The take-of mass is as stated above and relevant techniques are as described in GM1 CAT.POL.H.310(c) & CAT.POL.H.325(c).

It is unlikely that the DPATO will have to be calculated with operations to helidecks (due to the absence of obstacles in the take- off path).

- (ii) Additional requirements for operations to helidecks in a hostile environment

For a number of reasons (e.g. the deck size, and the helideck environment — including obstacles and wind vectors), it was not anticipated that operations in PC1 would be technically feasible or economically justifiable by the projected JAA deadline of 2010 (OEI HOGE could have provided a method of compliance, but this would have resulted in a severe and unwarranted restriction on payload/range).

However, due to the severe consequences of an engine failure to helicopters involved in take-off and landings to helidecks located in hostile sea areas (such as the North Sea or the North Atlantic), a policy of risk reduction is called for. As a result, enhanced class 2 take- off and landing masses together with techniques that provide a high confidence of safety due to:

- (A) deck-edge avoidance; and
- (B) drop- down that provides continued flight clear of the sea, are seen as practical measures.

For helicopters which have a Category A elevated helideck procedure, certification is satisfied by demonstrating a procedure and adjusted masses (adjusted for wind as well as temperature and pressure) that assure a 15-ft deck edge clearance on take-off and landing. It is, therefore, recommended that manufacturers, when providing enhanced PC2 procedures, use the provision of this deck-edge clearance as their benchmark.

As the height of the helideck above the sea is a variable, drop down has to be calculated; once clear of the helideck, a helicopter operating in PC1 would be expected to meet the 35-ft obstacle clearance. Under circumstances other than open sea areas and with less complex environmental conditions, this would not

present difficulties. As the provision of drop down takes no account of operational circumstances, standard drop down graphs for enhanced PC2 — similar to those in existence for Category A procedures — are anticipated.

Under conditions of offshore operations, calculation of drop down is not a trivial matter — the following examples indicate some of the problems which might be encountered in hostile environments:

- (A) Occasions when tide is not taken into account and the sea is running irregularly — the level of the obstacle (i.e. the sea) is indefinable making a true calculation of drop down impossible.
- (B) Occasions when it would not be possible — for operational reasons— for the approach and departure paths to be clear of obstacles — the ‘standard’ calculation of drop-down could not be applied.

Under these circumstances, practicality indicates that drop down should be based upon the height of the deck AMSL and the 35-ft clearance should be applied.

There are, however, other and more complex issues which will also affect the deck-edge clearance and drop down calculations.

- (C) When operating to moving decks on vessels, a recommended landing or take-off profile might not be possible because the helicopter might have to hover alongside in order that the rise and fall of the ship is mentally mapped; or, on take-off re-landing in the case of an engine failure might not be an option.

Under these circumstances, the commander might adjust the profiles to address a hazard more serious or more likely than that presented by an engine failure.

It is because of these and other (unforeseen) circumstances that a prescriptive requirement is not used. However, the target remains a 15-ft deck-edge clearance and a 35-ft obstacle clearance and data should be provided such that, where practically possible, these clearances can be planned.

As accident/incident history indicates that the main hazard is collision with obstacles on the helideck due to human error, simple and reproducible take-off and landing procedures are recommended.

In view of the reasons stated above, the future requirement for PC1 was replaced by the new requirement that the take-off mass takes into account:

- the procedure;
- deck-edge miss; and
- drop down appropriate to the height of the helideck.

This will require calculation of take-off mass from information produced by manufacturers reflecting these elements. It is expected that such information will be produced by performance modelling/simulation using a model validated through limited flight testing.

- (iii) Operations to helidecks for helicopters with a maximum operational passenger seating configuration (MOPSC) of more than 19

The original requirement for operations of helicopters with an MOPSC of more than 19 was PC1 (as set out in CAT.POL.H.100 (b)(2)).

However, when operating to helidecks, the problems enumerated in (g)(4)(ii) above are equally applicable to these helicopters. In view of this, but taking

into account that increased numbers are (potentially) being carried, such operations are permitted in PC2 (CAT.POL.H.100 (b)(2)) but, in all helideck environments (both hostile and non-hostile), have to satisfy, the additional requirements, set out in (g)(4)(ii) above.

**AMC1 CAT.POL.H.305(b) Helicopter operations without an assured safe forced landing capability**

## ENGINE RELIABILITY STATISTICS

- (a) As part of the risk assessment prior to granting an approval under CAT.POL.H.305, the operator should provide appropriate engine reliability statistics available for the helicopter type and the engine type.
- (b) Except in the case of new engines, such data should show sudden power loss from the set of in-flight shutdown (IFSD) events not exceeding 1 per 100 000 engine hours in a 5 year moving window. However, a rate in excess of this value, but not exceeding 3 per 100 000 engine hours, may be accepted by the competent authority after an assessment showing an improving trend.
- (c) New engines should be assessed on a case-by-case basis.
- (d) After the initial assessment, updated statistics should be periodically reassessed; any adverse sustained trend will require an immediate evaluation to be accomplished by the operator in consultation with the competent authority and the manufacturers concerned. The evaluation may result in corrective action or operational restrictions being applied.
- (e) The purpose of this paragraph is to provide guidance on how the in-service power plant sudden power loss rate is determined.
  - (1) Share of roles between the helicopter and engine type certificate holders (TCH)
    - (i) The provision of documents establishing the in-service sudden power loss rate for the helicopter/engine installation; the interface with the operational authority of the State of the operator should be the engine TCH or the helicopter TCH depending on the way they share the corresponding analysis work.
    - (ii) The engine TCH should provide the helicopter TCH with a document including: the list of in-service power loss events, the applicability factor for each event (if used), and the assumptions made on the efficiency of any corrective actions implemented (if used).
    - (iii) The engine or helicopter TCH should provide the operational authority of the State of the operator, with a document that details the calculation results taking into account the following:
      - (A) events caused by the engine and the events caused by the engine installation;
      - (B) applicability factor for each event (if used), the assumptions made on the efficiency of any corrective actions implemented on the engine and on the helicopter (if used); and
      - (C) calculation of the power plant power loss rate.
  - (2) Documentation

The following documentation should be updated every year:

    - (i) the document with detailed methodology and calculation as distributed to the authority of the State of design;
    - (ii) a summary document with results of computation as made available on request to any operational authority; and
    - (iii) a service letter establishing the eligibility for such operation and defining the corresponding required configuration as provided to the operators.
  - (3) Definition of 'sudden in-service power loss'

Sudden in-service power loss is an engine power loss:

- (i) larger than 30 % of the take-off power;
- (ii) occurring during operation; and
- (iii) without the occurrence of an early intelligible warning to inform and give sufficient time for the pilot to take any appropriate action.

(4) Database documentation

Each power loss event should be documented, by the engine and/or helicopter TCHs, as follows:

- (i) incident report number;
- (ii) engine type;
- (iii) engine serial number;
- (iv) helicopter serial number;
- (v) date;
- (vi) event type (demanded IFSD, un-demanded IFSD);
- (vii) presumed cause;
- (viii) applicability factor when used; and
- (ix) reference and assumed efficiency of the corrective actions that will have to be applied (if any).

(5) Counting methodology

Various methodologies for counting engine power loss rate have been accepted by authorities. The following is an example of one of these methodologies.

- (i) The events resulting from:
  - (A) unknown causes (wreckage not found or totally destroyed, undocumented or unproven statements);
  - (B) where the engine or the elements of the engine installation have not been investigated (for example, when the engine has not been returned by the customer); or
  - (C) an unsuitable or non-representative use (operation or maintenance) of the helicopter or the engine,

are not counted as engine in-service sudden power loss and the applicability factor is 0 %.

- (ii) The events caused by:
  - (A) the engine or the engine installation; or
  - (B) the engine or helicopter maintenance, when the applied maintenance was compliant with the maintenance manuals,

are counted as engine in-service sudden power loss and the applicability factor is 100 %.

- (iii) For the events where the engine or an element of the engine installation has been submitted for investigation, but where this investigation subsequently failed to define a presumed cause, the applicability factor is 50 %.

(6) Efficiency of corrective actions

The corrective actions made by the engine and helicopter manufacturers on the definition or maintenance of the engine or its installation may be defined as mandatory for specific operations. In this case, the associated reliability improvement may be considered as a mitigating factor for the event.

A factor defining the efficiency of the corrective action may be applied to the applicability factor of the concerned event.



(7) Method of calculation of the power plant power loss rate

The detailed method of calculation of the power plant power loss rate should be documented by engine or helicopter TCH and accepted by the relevant authority.

**AMC2 CAT.POL.H.305(b) Helicopter operations without an assured safe forced landing capability**

IMPLEMENTATION OF THE SET OF CONDITIONS

To obtain an approval under CAT.POL.H.305(a), the operator conducting operations without an assured safe forced landing capability should implement the following:

- (a) Attain and then maintain the helicopter/engine modification standard defined by the manufacturer that has been designated to enhance reliability during the take-off and landing phases.
- (b) Conduct the preventive maintenance actions recommended by the helicopter or engine manufacturer as follows:
  - (1) engine oil spectrometric and debris analysis — as appropriate;
  - (2) engine trend monitoring, based on available power assurance checks;
  - (3) engine vibration analysis (plus any other vibration monitoring systems where fitted); and
  - (4) oil consumption monitoring.
- (c) The usage monitoring system should fulfil at least the following:
  - (1) Recording of the following data:
    - (i) date and time of recording, or a reliable means of establishing these parameters;
    - (ii) amount of flight hours recorded during the day plus total flight time;
    - (iii) N1 (gas producer RPM) cycle count;
    - (iv) N2 (power turbine RPM) cycle count (if the engine features a free turbine);
    - (v) turbine temperature exceedance: value, duration;
    - (vi) power-shaft torque exceedance: value, duration (if a torque sensor is fitted);
    - (vii) engine shafts speed exceedance: value, duration.
  - (2) Data storage of the above parameters, if applicable, covering the maximum flight time in a day, and not less than 5 flight hours, with an appropriate sampling interval for each parameter.
  - (3) The system should include a comprehensive self-test function with a malfunction indicator and a detection of power-off or sensor input disconnection.
  - (4) A means should be available for downloading and analysis of the recorded parameters. Frequency of downloading should be sufficient to ensure data are not lost through overwriting.
  - (5) The analysis of parameters gathered by the usage monitoring system, the frequency of such analysis and subsequent maintenance actions should be described in the maintenance documentation.
  - (6) The data should be stored in an acceptable form and accessible to the competent authority for at least 24 months.
- (d) The training for flight crew should include the discussion, demonstration, use and practice of the techniques necessary to minimise the risks.

- (e) Report to the manufacturer any loss of power control, engine shutdown (precautionary or otherwise) or engine failure for any cause (excluding simulation of engine failure during training). The content of each report should provide:
- (1) date and time;
  - (2) operator (and maintenance organisations where relevant);
  - (3) type of helicopter and description of operations;
  - (4) registration and serial number of airframe;
  - (5) engine type and serial number;
  - (6) power unit modification standard where relevant to failure;
  - (7) engine position;
  - (8) symptoms leading up to the event;
  - (9) circumstances of engine failure including phase of flight or ground operation;
  - (10) consequences of the event;
  - (11) weather/environmental conditions;
  - (12) reason for engine failure — if known;
  - (13) in case of an in-flight shutdown (IFSD), nature of the IFSD (demanded/un-demanded);
  - (14) procedure applied and any comment regarding engine restart potential;
  - (15) engine hours and cycles (from new and last overhaul);
  - (16) airframe flight hours;
  - (17) rectification actions applied including, if any, component changes with part number and serial number of the removed equipment; and
  - (18) any other relevant information.

### **GM1 CAT.POL.H.305(b) Helicopter operations without an assured safe forced landing capability**

#### USE OF FULL AUTHORITY DIGITAL ENGINE CONTROL (FADEC)

Current technology increasingly allows for the recording function required in (c)(1) of AMC2 CAT.POL.H.305(b) to be incorporated in the full authority digital engine control (FADEC).

Where a FADEC is capable of recording some of the parameters required by (c)(1) of AMC2 CAT.POL.H.305(b), it is not intended that the recording of the parameters is to be duplicated.

Providing that the functions as set out in (c) of AMC2 CAT.POL.H.305(b) are satisfied, the FADEC may partially, or in whole, fulfil the requirement for recording and storing parameters in a usage monitoring system.

### **GM1 CAT.POL.H.310(c) & CAT.POL.H.325(c) Take-off and landing**

#### PROCEDURE FOR CONTINUED OPERATIONS TO HELIDECKS

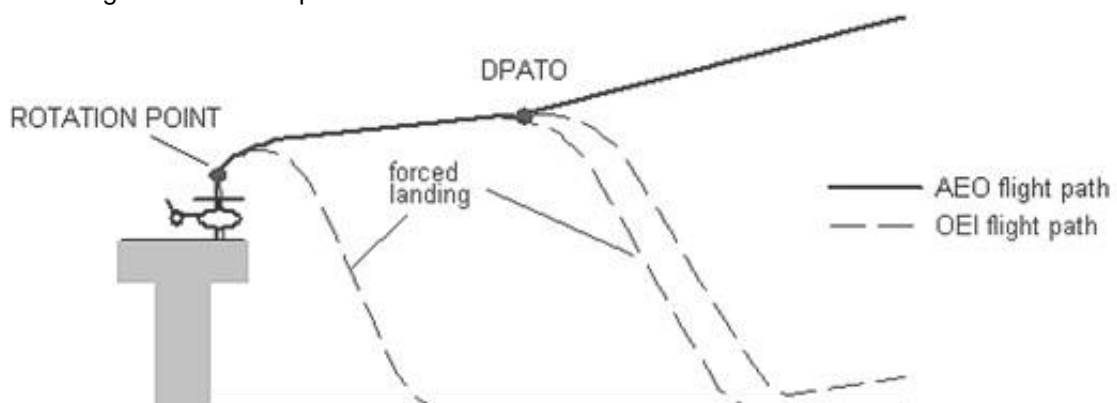
- (a) Factors to be considered when taking off from or landing on a helideck

- (1) In order to take account of the considerable number of variables associated with the helideck environment, each take-off and landing may require a slightly different profile. Factors such as helicopter mass and centre of gravity, wind velocity, turbulence, deck size, deck elevation and orientation, obstructions, power margins, platform gas turbine exhaust plumes etc., will influence both the take-off and landing. In particular, for the landing, additional considerations such as the need for a clear go-around flight path, visibility and cloud base, etc. will affect the commander's decision on the choice of landing profile. Profiles may be modified, taking account of the relevant factors noted above and the characteristics of individual helicopter types.
- (b) Performance
- (1) To perform the following take-off and landing profiles, adequate all engines operating (AEO) hover performance at the helideck is required. In order to provide a minimum level of performance, data (derived from the AFM AEO out of ground effect (OGE)) should be used to provide the maximum take-off or landing mass. Where a helideck is affected by downdrafts or turbulence or hot gases, or where the take-off or landing profile is obstructed, or the approach or take-off cannot be made into wind, it may be necessary to decrease this take-off or landing mass by using a suitable calculation method. The helicopter mass should not exceed that required by CAT.POL.H.310(a) or CAT.POL.H.325(a).

(For helicopter types no longer supported by the manufacturer, data may be established by the operator, provided it is acceptable to the competent authority.)

- (c) Take-off profile
- (1) The take-off should be performed in a dynamic manner ensuring that the helicopter continuously moves vertically from the hover to the rotation point (RP) and thence into forward flight. If the manoeuvre is too dynamic, then there is an increased risk of losing spatial awareness (through loss of visual cues) in the event of a rejected take-off, particularly at night.
- (2) If the transition to forward flight is too slow, the helicopter is exposed to an increased risk of contacting the deck edge in the event of an engine failure at or just after the point of cyclic input (RP).
- (3) It has been found that the climb to RP is best made between 110 % and 120 % of the power required in the hover. This power offers a rate of climb that assists with deck-edge clearance following engine failure at RP, whilst minimising ballooning following a failure before RP. Individual types will require selection of different values within this range.

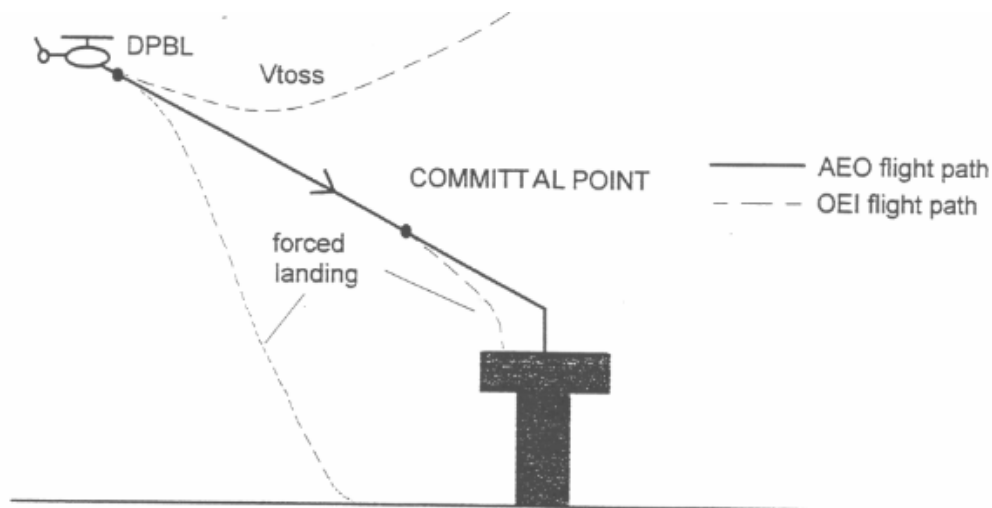
Figure 1: Take-off profile



- (d) Selection of a lateral visual cue
  - (1) In order to obtain the maximum performance in the event of an engine failure being recognised at or just after RP, the RP should be at its optimum value, consistent with maintaining the necessary visual cues. If an engine failure is recognised just before RP, the helicopter, if operating at a low mass, may 'balloon' a significant height before the reject action has any effect. It is, therefore, important that the pilot flying selects a lateral visual marker and maintains it until the RP is achieved, particularly on decks with few visual cues. In the event of a rejected take-off, the lateral marker will be a vital visual cue in assisting the pilot to carry out a successful landing.
- (e) Selection of the rotation point
  - (1) The optimum RP should be selected to ensure that the take-off path will continue upwards and away from the deck with AEO, but minimising the possibility of hitting the deck edge due to the height loss in the event of an engine failure at or just after RP.
  - (2) The optimum RP may vary from type to type. Lowering the RP will result in a reduced deck edge clearance in the event of an engine failure being recognised at or just after RP. Raising the RP will result in possible loss of visual cues, or a hard landing in the event of an engine failure just prior to RP.
- (f) Pilot reaction times
  - (1) Pilot reaction time is an important factor affecting deck edge clearance in the event of an engine failure prior to or at RP. Simulation has shown that a delay of 1 second can result in a loss of up to 15 ft in deck edge clearance.
- (g) Variation of wind speed
  - (1) Relative wind is an important parameter in the achieved take-off path following an engine failure; wherever practicable, take-off should be made into wind. Simulation has shown that a 10-kt wind can give an extra 5-ft deck edge clearance compared to a zero wind condition.
- (h) Position of the helicopter relative to the deck edge
  - (1) It is important to position the helicopter as close to the deck edge (including safety nets) as possible whilst maintaining sufficient visual cues, particularly a lateral marker.
  - (2) The ideal position is normally achieved when the rotor tips are positioned at the forward deck edge. This position minimises the risk of striking the deck edge following recognition of an engine failure at or just after RP. Any take-off heading which causes the helicopter to fly over obstructions below and beyond the deck edge should be avoided if possible. Therefore, the final take-off heading and position will be a compromise between the take-off path for least obstructions, relative wind, turbulence and lateral marker cue considerations.
- (i) Actions in the event of an engine failure at or just after RP
  - (1) Once committed to the continued take-off, it is important, in the event of an engine failure, to rotate the aircraft to the optimum attitude in order to give the best chance of missing the deck edge. The optimum pitch rates and absolute pitch attitudes should be detailed in the profile for the specific type.
- (j) Take-off from helidecks that have significant movement

- (1) This technique should be used when the helideck movement and any other factors, e.g. insufficient visual cues, makes a successful rejected take-off unlikely. Weight should be reduced to permit an improved one-engine-inoperative capability, as necessary.
  - (2) The optimum take-off moment is when the helideck is level and at its highest point, e.g. horizontal on top of the swell. Collective pitch should be applied positively and sufficiently to make an immediate transition to climbing forward flight. Because of the lack of a hover, the take-off profile should be planned and briefed prior to lift off from the deck.
- (k) Standard landing profile
- (1) The approach should be commenced into wind to a point outboard of the helideck. Rotor tip clearance from the helideck edge should be maintained until the aircraft approaches this position at the requisite height (type dependent) with approximately 10 kt of ground- speed and a minimal rate of descent. The aircraft is then flown on a flight path to pass over the deck edge and into a hover over the safe landing area.

**Figure 2:** Standard landing profile



- (l) Offset landing profile
- (1) If the normal landing profile is impracticable due to obstructions and the prevailing wind velocity, the offset procedure may be used. This should involve flying to a hover position, approximately 90° offset from the landing point, at the appropriate height and maintaining rotor tip clearance from the deck edge. The helicopter should then be flown slowly but positively sideways and down to position in a low hover over the landing point. Normally, the committal point (CP) will be the point at which helicopter begins to transition over the helideck edge.
- (m) Training
- (1) These techniques should be covered in the training required by Annex III (Part- ORO).

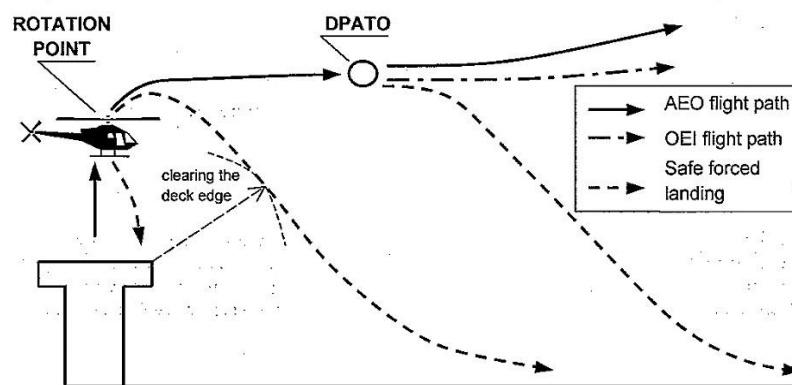
## **GM1 CAT.POL.H.310 & CAT.POL.H.325 Take-off and landing**

### **TAKE-OFF AND LANDING TECHNIQUES**

- (a) This GM describes three types of operation to/from helidecks and elevated FATOs by helicopters operating in performance class 2.

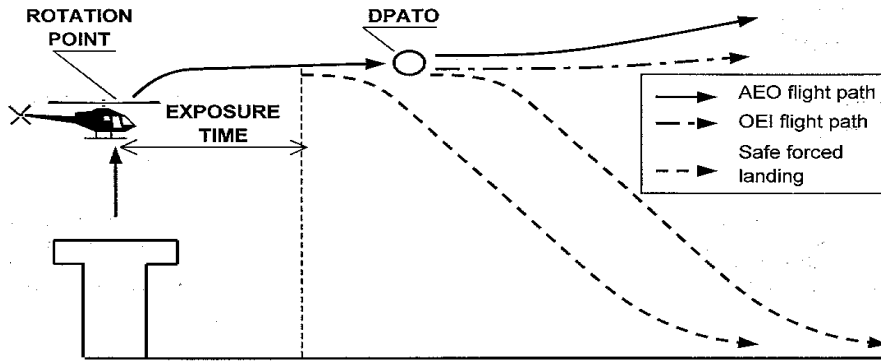
- (b) In two cases of take-off and landing, exposure time is used. During the exposure time (which is only approved for use when complying with CAT.POL.H.305), the probability of an engine failure is regarded as extremely remote. If an engine failure occurs during the exposure time, a safe forced landing may not be possible.
- (c) Take-off — non- hostile environment (without an approval to operate with an exposure time) CAT.POL.H.310(b).
- (1) Figure 1 shows a typical take-off profile for performance class 2 operations from a helideck or an elevated FATO in a non- hostile environment.
  - (2) If an engine failure occurs during the climb to the rotation point, compliance with CAT.POL.H.310(b) will enable a safe landing or a safe forced landing on the deck.
  - (3) If an engine failure occurs between the rotation point and the DPATO, compliance with CAT.POL.H.310(b) will enable a safe forced landing on the surface, clearing the deck edge.
  - (4) At or after the DPATO, the OEI flight path should clear all obstacles by the margins specified in CAT.POL.H.315.

Figure 1: Typical take-off profile PC2 from a helideck/elevated FATO, non-hostile environment



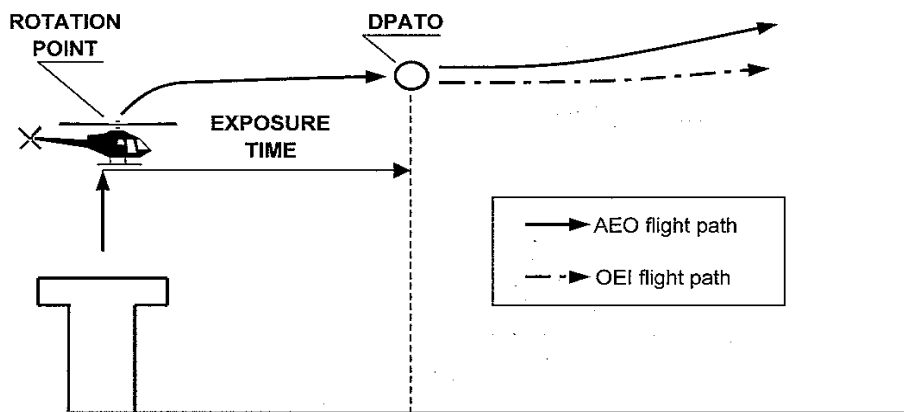
- (d) Take- off — non- hostile environment (with exposure time) CAT.POL.H.310(c)
- (1) Figure 2 shows a typical take-off profile for performance class 2 operations from a helideck or an elevated FATO in a non-hostile environment (with exposure time).
  - (2) If an engine failure occurs after the exposure time and before DPATO, compliance with CAT.POL.H.310(c) will enable a safe forced landing on the surface.
  - (3) At or after the DPATO, the OEI flight path should clear all obstacles by the margins specified in CAT.POL.H.315.

Figure 2: Typical take-off profile PC2 from a helideck/elevated FATO with exposure time, non- hostile environment



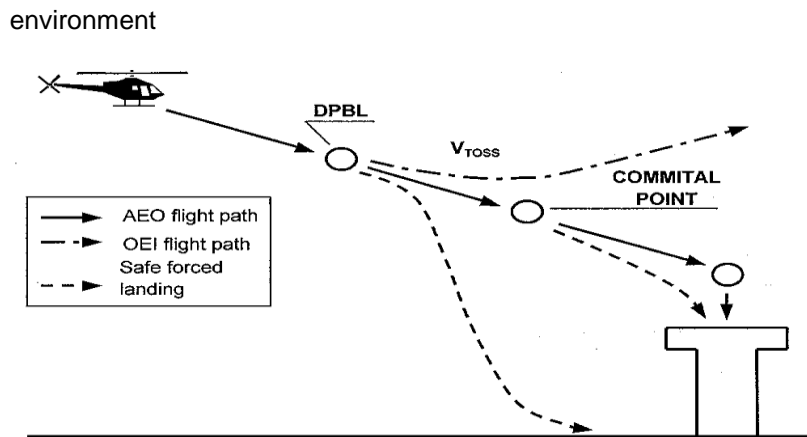
- (e) Take-off—non-congested hostile environment (with exposure time) CAT.POL.H.310(c)
- (1) Figure 3 shows a typical take off profile for performance class 2 operations from a helideck or an elevated FATO in a non-congested hostile environment (with exposure time).
  - (2) If an engine failure occurs after the exposure time, the helicopter is capable of a safe forced landing or safe continuation of the flight.
  - (3) At or after the DPATO, the OEI flight path should clear all obstacles by the margins specified in CAT.POL.H.315.

**Figure 3:** Typical take-off profile PC2 from a helideck/elevated FATO, non-congested hostile environment



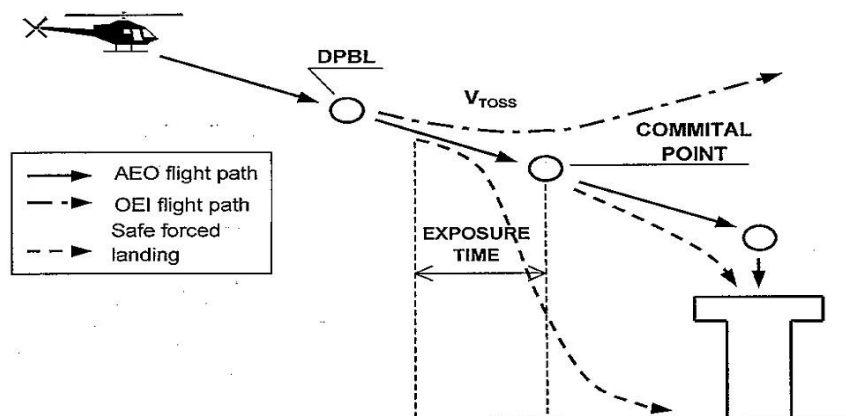
- (f) Landing — non-hostile environment (without an approval to operate with an exposure time) CAT.POL.H.325 (b)
- (1) Figure 4 shows a typical landing profile for performance class 2 operations to a helideck or an elevated FATO in a non-hostile environment.
  - (2) The DPBL is defined as a ‘window’ in terms of airspeed, rate of descent, and height above the landing surface. If an engine failure occurs before the DPBL, the pilot may elect to land or to execute a balked landing.
  - (3) In the event of an engine failure being recognised after the DPBL and before the committal point, compliance with CAT.POL.H.325(b) will enable a safe forced landing on the surface.
  - (4) In the event of an engine failure at or after the committal point, compliance with CAT.POL.H.325(b) will enable a safe forced landing on the deck.

**Figure 4:** Typical landing profile PC2 to a helideck/elevated FATO, non-hostile



- (g) Landing — non- hostile environment (with exposure time) CAT.POL.H.325 (c)
  - (1) Figure 5 shows a typical landing profile for performance class 2 operations to a helideck or an elevated FATO in a non-hostile environment (with exposure time).
  - (2) The DPBL is defined as a ‘window’ in terms of airspeed, rate of descent, and height above the landing surface. If an engine failure occurs before the DPBL, the pilot may elect to land or to execute a bailed landing.
  - (3) In the event of an engine failure being recognised before the exposure time, compliance with CAT.POL.H.325(c) will enable a safe forced landing on the surface.
  - (4) In the event of an engine failure after the exposure time, compliance with CAT.POL.H.325(c) will enable a safe forced landing on the deck.

Figure 5: Typical landing profile PC2 to a helideck/elevated FATO with exposure time, non-hostile environment

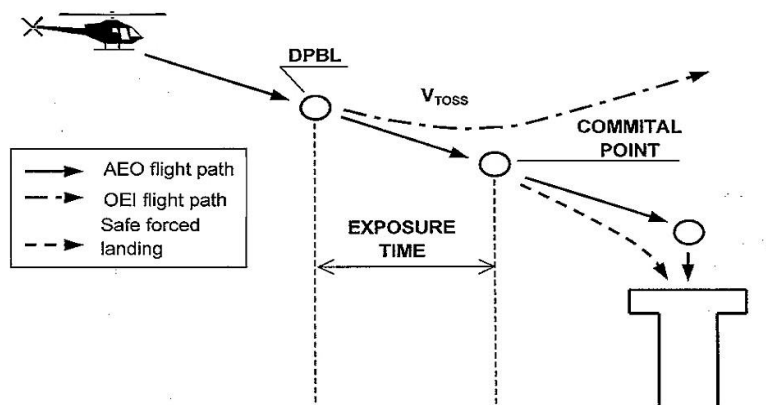


- (h) Landing—non-congested hostile environment (with exposure time) CAT.POL.H.325(c)
  - (1) Figure 6 shows a typical landing profile for performance class 2 operations to a helideck or an elevated FATO in a non-congested hostile environment (with exposure time).
  - (2) In the event of an engine failure at any point during the approach and landing phase up to the start of exposure time, compliance with CAT.POL.H.325(b) will enable the helicopter, after clearing all obstacles under the flight path, to continue the flight.



- (3) In the event of an engine failure after the exposure time (i.e. at or after the committal point), a safe forced landing should be possible on the deck.

**Figure 6:** Typical landing profile PC2 to a helideck/elevated FATO with exposure time, non- congested hostile environment



## Chapter 4 — Performance class 3

### GM1 CAT.POL.H.400(c) General

#### THE TAKE-OFF AND LANDING PHASES (PERFORMANCE CLASS 3)

- (a) To understand the use of ground level exposure in performance class 3, it is important first to be aware of the logic behind the use of 'take-off and landing phases'. Once this is clear, it is easier to appreciate the aspects and limits of the use of ground level exposure. This GM shows the derivation of the term from the ICAO definition of the 'en- route phase' and then gives practical examples of the use, and limitations on the use, of ground level exposure in CAT.POL.400(c).
- (b) The take- off phase in performance class 1 and performance class 2 may be considered to be bounded by 'the specified point in the take- off' from which the take- off flight path begins.
  - (1) In performance class 1, this specified point is defined as 'the end of the take-off distance required'.
  - (2) In performance class 2, this specified point is defined as DPATO or, as an alternative, no later than 200 ft above the take-off surface.
  - (3) There is no simple equivalent point for bounding of the landing in performance classes 1 & 2.
- (c) Take-off flight path is not used in performance class 3 and, consequently, the term 'take-off and landing phases' is used to bound the limit of exposure. For the purpose of performance class 3, the take- off and landing phases are as set out in CAT.POL.H.400(c) and are considered to be bounded by:
  - (1) during take-off before reaching  $V_y$  (speed for best rate of climb) or 200 ft above the take-off surface; and
  - (2) during landing, below 200 ft above the landing surface.

(ICAO Annex 6 Part III, defines en-route phase as being "That part of the flight from the end of the take-off and initial climb phase to the commencement of the approach and landing phase." The use of take- off and landing phase in this text is used to distinguish the take-off from the initial climb, and the landing from the approach: they are considered to be complimentary and not contradictory.)
- (d) Ground level exposure — and exposure for elevated FATOs or helidecks in a non-hostile environment — is permitted for operations under an approval in accordance with CAT.POL.H.305. Exposure in this case is limited to the 'take-off and landing phases'.

The practical effect of bounding of exposure can be illustrated with the following examples:

- (1) A clearing: the operator may consider a take-off/landing in a clearing when there is sufficient power, with all engines operating, to clear all obstacles in the take-off path by an adequate margin (this, in ICAO, is meant to indicate 35 ft). Thus, the clearing may be bounded by bushes, fences, wires and, in the extreme, by power lines, high trees, etc. Once the obstacle has been cleared, by using a steep or a vertical climb (which itself may infringe the height velocity (HV) diagram), the helicopter reaches  $V_y$  or 200 ft, and from that point a safe forced landing must be possible. The effect is that whilst operation to a clearing is possible, operation to a clearing in the middle of a forest is not (except when operated in accordance with CAT.POL.H.420).

- (2) An aerodrome/operating site surrounded by rocks: the same applies when operating to a landing site that is surrounded by rocky ground. Once  $V_y$  or 200 ft has been reached, a safe forced landing must be possible.
- (3) An elevated FATO or helideck: when operating to an elevated FATO or helideck in performance class 3, exposure is considered to be twofold: firstly, to a deck-edge strike if the engine fails after the decision to transition has been taken; and secondly, to operations in the HV diagram due to the height of the FATO or helideck. Once the take-off surface has been cleared and the helicopter has reached the knee of the HV diagram, the helicopter should be capable of making a safe forced landing.
- (e) Operation in accordance with CAT.POL.400(b) does not permit excursions into a hostile environment as such and is specifically concerned with the absence of space to abort the take-off or landing when the take-off and landing space are limited; or when operating in the HV diagram.
- (f) Specifically, the use of this exception to the requirement for a safe forced landing (during take-off or landing) does not permit semi-continuous operations over a hostile environment such as a forest or hostile sea area.

### **AMC1 CAT.POL.H.420 Helicopter operations over a hostile environment located outside a congested area**

#### **SAFETY RISK ASSESSMENT**

##### (a) Introduction

Two cases that are deemed to be acceptable for the alleviation under the conditions of CAT.POL.H.420 for the en-route phase of the flight (operations without an assured safe forced landing capability during take-off and landing phases are subject to a separate approval under CAT.POL.H.400(c)) are flights over mountainous areas and remote areas, both already having been considered by the JAA in comparison to ground transport in the case of remote areas and respectively to multi-engined helicopters in the case of mountain areas.

##### (1) Remote areas

Remote area operation is acceptable when alternative surface transportation does not provide the same level of safety as helicopter transportation. In this case, the operator should demonstrate why the economic circumstances do not justify replacement of single-engined helicopters by multi-engined helicopters.

##### (2) Mountainous areas

Current generation twin-engined helicopters may not be able to meet the performance class 1 or 2 requirements at the operational altitude; consequently, the outcome of an engine failure is the same as a single-engined helicopter. In this case, the operator should justify the use of exposure in the en-route phase.

##### (b) Other areas of operation

For other areas of operations to be considered for the operational approval, a risk assessment should be conducted by the operator that should, at least, consider the following factors:

- (1) type of operations and the circumstances of the flight;
- (2) area/terrain over which the flight is being conducted;
- (3) probability of an engine failure and the consequence of such an event;
- (4) safety target;
- (5) procedures to maintain the reliability of the engine(s);
- (6) installation and utilisation of a usage monitoring system; and

- (7) when considered relevant, any available publications on (analysis of) accident or other safety data.

## **GM1 CAT.POL.H.420 Helicopter operations over a hostile environment located outside a congested area**

### EXAMPLE OF A SAFETY RISK ASSESSMENT

#### (a) Introduction

Where it can be substantiated that helicopter limitations, or other justifiable considerations, preclude the use of appropriate performance, the approval effectively alleviates from compliance with the requirement in CAT.OP.MPA.137, that requires the availability of surfaces that permit a safe forced landing to be executed.

Circumstances where an engine failure will result in a catastrophic event are those defined for a hostile environment:

- (1) a lack of adequate surfaces to perform a safe landing;
- (2) the inability to protect the occupants of the helicopter from the elements; or
- (3) a lack of search and rescue services to provide rescue consistent with the expected survival time in such environment.

#### (b) The elements of the risk assessment

The risk assessment process consists of the application of three principles:

- a safety target;
- a helicopter reliability assessment; and
- continuing airworthiness.

##### (1) The safety target

The main element of the risk assessment when exposure was initially introduced by the JAA into JAR-OPS 3 (NPA OPS-8), was the assumption that turbine engines in helicopters would have failure rates of about 1:100 000 per flying hour — which would permit (against the agreed safety target of  $5 \times 10^{-8}$  per event) an exposure of about 9 seconds for twin-engined helicopters and 18 seconds for single- engined helicopters during the take- off or landing event.

An engine failure in the en- route phase over a hostile environment will inevitably result in a higher risk (in the order of magnitude of  $1 \times 10^{-5}$  per flying hour) to a catastrophic event.

The approval to operate with this high risk of endangering the helicopter occupants should, therefore, only be granted against a comparative risk assessment (i.e. compared to other means of transport, the risk is demonstrated to be lower), or where there is no economic justification to replace single-engined helicopters by multi-engined helicopters.

##### (2) The reliability assessment

The purpose of the reliability assessment is to ensure that the engine reliability remains at or better than  $1 \times 10^{-5}$ .

##### (3) Continuing airworthiness

Mitigating procedures consist of a number of elements:

- (i) the fulfilment of all manufacturers' safety modifications;
- (ii) a comprehensive reporting system(both failures and usage data); and
- (iii) the implementation of a usage monitoring system(UMS).

Each of these elements is to ensure that engines, once shown to be sufficiently reliable to meet the safety target, will sustain such reliability (or improve upon it).

The monitoring system is felt to be particularly important as it had already been demonstrated that when such systems are in place, it inculcates a more considered approach to operations. In addition, the elimination of 'hot starts', prevented by the UMS, itself minimises the incidents of turbine burst failures.

**GM2 CAT.POL.H.420(a) Helicopter operations over a hostile environment located outside a congested area**

ENDORSEMENT FROM ANOTHER STATE

(a) Application to another State

To obtain an endorsement from another State, the operator should submit to that State the safety risk assessment and the reasons and justification that preclude the use of appropriate performance criteria, over those hostile areas outside a congested area over which the operator is planning to conduct operations.

(b) Endorsement from another State

Upon receiving the endorsement from another State, the operator should submit it together with the safety risk assessment and the reasons and justification that preclude the use of appropriate performance criteria, to the competent authority issuing the AOC to obtain the approval or extend the existing approval to a new area.

## SECTION 3 — Mass and balance

### Chapter 1 — Motor-powered aircraft

#### AMC1 CAT.POL.MAB.100(a) Mass and balance, loading

##### CENTRE OF GRAVITY LIMITS — OPERATIONAL CG ENVELOPE AND IN-FLIGHT CG

In the Certificate Limitations section of the AFM, forward and aft CG limits are specified. These limits ensure that the certification stability and control criteria are met throughout the whole flight and allow the proper trim setting for take-off. The operator should ensure that these limits are respected by:

- (a) Defining and applying operational margins to the certified CG envelope in order to compensate for the following deviations and errors:
  - (1) Deviations of actual CG at empty or operating mass from published values due, for example, to weighing errors, unaccounted modifications and/or equipment variations.
  - (2) Deviations in fuel distribution in tanks from the applicable schedule.
  - (3) Deviations in the distribution of baggage and cargo in the various compartments as compared with the assumed load distribution as well as inaccuracies in the actual mass of baggage and cargo.
  - (4) Deviations in actual passenger seating from the seating distribution assumed when preparing the mass and balance documentation. Large CG errors may occur when 'free seating', i.e. freedom of passengers to select any seat when entering the aircraft, is permitted. Although in most cases reasonably even longitudinal passenger seating can be expected, there is a risk of an extreme forward or aft seat selection causing very large and unacceptable CG errors, assuming that the balance calculation is done on the basis of an assumed even distribution. The largest errors may occur at a load factor of approximately 50% if all passengers are seated in either the forward or aft half of the cabin. Statistical analysis indicates that the risk of such extreme seating adversely affecting the CG is greatest on small aircraft.
  - (5) Deviations of the actual CG of cargo and passenger load within individual cargo compartments or cabin sections from the normally assumed mid position.
  - (6) Deviations of the CG caused by gear and flap positions and by application of the prescribed fuel usage procedure, unless already covered by the certified limits.
  - (7) Deviations caused by in-flight movement of cabin crew, galley equipment and passengers.
  - (8) On small aeroplanes, deviations caused by the difference between actual passenger masses and standard passenger masses when such masses are used.
- (b) Defining and applying operational procedures in order to:
  - (1) ensure an even distribution of passengers in the cabin;
  - (2) take into account any significant CG travel during flight caused by passenger/crew movement; and
  - (3) take into account any significant CG travel during flight caused by fuel consumption/transfer.

**AMC1 CAT.POL.MAB.100(b) Mass and balance, loading**

## WEIGHING OF AN AIRCRAFT

- (a) New aircraft that have been weighed at the factory may be placed into operation without reweighing if the mass and balance records have been adjusted for alterations or modifications to the aircraft.
- (b) The mass and centre of gravity (CG) position of an aircraft should be revised whenever the cumulative changes to the dry operating mass exceed  $\pm 0.5\%$  of the maximum landing mass or, for aeroplanes, the cumulative change in CG position exceeds  $0.5\%$  of the mean aerodynamic chord. This may be done by weighing the aircraft or by calculation. If the AFM requires to record changes to mass and CG position below these thresholds, or to record changes in any case, and make them known to the commander, mass and CG position should be revised accordingly and made known to the commander.
- (c) When weighing an aircraft, normal precautions should be taken consistent with good practices such as:
- (1) checking for completeness of the aircraft and equipment;
  - (2) determining that fluids are properly accounted for;
  - (3) ensuring that the aircraft is clean; and
  - (4) ensuring that weighing is accomplished in an enclosed building.
- (d) Any equipment used for weighing should be properly calibrated, zeroed, and used in accordance with the manufacturer's instructions. Each scale should be calibrated either by the manufacturer, by a civil department of weights and measures or by an appropriately authorised organisation within two years or within a time period defined by the manufacturer of the weighing equipment, whichever is less. The equipment should enable the mass of the aircraft to be established accurately. One single accuracy criterion for weighing equipment cannot be given. However, the weighing accuracy is considered satisfactory if the accuracy criteria in Table 1 are met by the individual scales/cells of the weighing equipment used:

Table 1: Accuracy criteria for weighing equipment

For a scale/cell load	An accuracy of
below 2 000 kg	$\pm 1\%$
From 2 000 kg to 20 000 kg	$\pm 20$ kg
above 20 000 kg	$\pm 0.1\%$

**AMC2 CAT.POL.MAB.100(b) Mass and balance, loading****FLEET MASS AND CG POSITION — AEROPLANES**

- (a) For a group of aeroplanes of the same model and configuration, an average dry operating mass and CG position may be used as the fleet mass and CG position, provided that:
- (1) the dry operating mass of an individual aeroplane does not differ by more than  $\pm 0.5\%$  of the maximum structural landing mass from the established dry operating fleet mass; or
  - (2) the CG position of an individual aeroplane does not differ by more than  $\pm 0.5\%$  of the mean aerodynamic chord from the established fleet CG.
- (b) The operator should verify that, after an equipment or configuration change or after weighing, the aeroplane falls within the tolerances above.
- (c) To add an aeroplane to a fleet operated with fleet values, the operator should verify by weighing or calculation that its actual values fall within the tolerances specified in (a)(1) and (2).
- (d) To obtain fleet values, the operator should weigh, in the period between two fleet mass evaluations, a certain number of aeroplanes as specified in Table 1, where 'n' is the number of aeroplanes in the fleet using fleet values. Those aeroplanes in the fleet that have not been weighed for the longest time should be selected first.

Table 1: Minimum number of weighings to obtain fleet values

Number of aeroplanes in the fleet	Minimum number of weighings
2 or 3	n
4 to 9	$(n + 3)/2$
10 or more	$(n + 51)/10$

- (e) The interval between two fleet mass evaluations should not exceed 48 months.
- (f) The fleet values should be updated at least at the end of each fleet mass evaluation.
- (g) Aeroplanes that have not been weighed since the last fleet mass evaluation may be kept in a fleet operated with fleet values, provided that the individual values are revised by calculation and stay within the tolerances above. If these individual values no longer fall within the tolerances, the operator should determine new fleet values or operate aeroplanes not falling within the limits with their individual values.
- (h) If an individual aeroplane mass is within the dry operating fleet mass tolerance but its CG position exceeds the tolerance, the aeroplane may be operated under the applicable dry operating fleet mass but with an individual CG position.
- (i) Aeroplanes for which no mean aerodynamic chord has been published, should be operated with their individual mass and CG position values. They may be operated under the dry operating fleet mass and CG position, provided that a risk assessment has been completed.



**AMC1 CAT.POL.MAB.100(d) Mass and balance, loading**

## DRY OPERATING MASS

The dry operating mass includes:

- (a) crew and crew baggage;
- (b) catering and removable passenger service equipment; and
- (c) tank water and lavatory chemicals.

**AMC2 CAT.POL.MAB.100(d) Mass and balance, loading**

## MASS VALUES FOR CREW MEMBERS

- (a) The operator should use the following mass values for crew to determine the dry operating mass:
  - (1) actual masses including any crew baggage; or
  - (2) standard masses, including hand baggage, of 85 kg for flight crew/technical crew members and 75 kg for cabin crew members.
- (b) The operator should correct the dry operating mass to account for any additional baggage. The position of this additional baggage should be accounted for when establishing the centre of gravity of the aeroplane.

**AMC1 CAT.POL.MAB.100(e) Mass and balance, loading**

## MASS VALUES FOR PASSENGERS AND BAGGAGE

- (a) When the number of passenger seats available is:
  - (1) less than 10 for aeroplanes; or
  - (2) less than 6 for helicopters,

passenger mass may be calculated on the basis of a statement by, or on behalf of, each passenger, adding to it a predetermined mass to account for hand baggage and clothing.

The predetermined mass for hand baggage and clothing should be established by the operator on the basis of studies relevant to his particular operation. In any case, it should not be less than:

- (1) 4 kg for clothing; and
- (2) 6 kg for hand baggage.

The passengers' stated mass and the mass of passengers' clothing and hand baggage should be checked prior to boarding and adjusted, if necessary. The operator should establish a procedure in the operations manual when to select actual or standard masses and the procedure to be followed when using verbal statements.

- (b) When determining the actual mass by weighing, passengers' personal belongings and hand baggage should be included. Such weighing should be conducted immediately prior to boarding the aircraft.
- (c) When determining the mass of passengers by using standard mass values, the standard mass values in Tables 1 and 2 below should be used. The standard masses include hand baggage and the mass of any infant carried by an adult on one passenger seat. Infants occupying separate passenger seats should be considered as children for the purpose of this AMC. When the total number of passenger seats available on an aircraft is 20 or more, the standard masses for males and females in Table 1 should be used. As an alternative, in cases where the total number of passenger seats available is 30 or more, the 'All Adult' mass values in Table 1 may be used.

Table 1: Standard masses for passengers — aircraft with a total number of passenger seats of 20 or more

Passenger seats	20 and more		30 and more
	Male	Female	All Adult
All flights except holiday charters	88 kg	70 kg	84 kg
Holiday charters*	83 kg	69 kg	76 kg
Children	35 kg	35 kg	35 kg

\* Holiday charter means a charter flight that is part of a holiday travel package. On such flights the entire passenger capacity is hired by one or more charterer(s) for the carriage of passengers who are travelling, all or in part by air, on a round - or circle-trip basis for holiday purposes. The holiday charter mass values apply provided that not more than 5 % of passenger seats installed in the aircraft are used for the non-revenue carriage of certain categories of passengers. Categories of passengers such as company personnel, tour operators' staff, representatives of the press, authority officials, etc. can be included within the 5% without negating the use of holiday charter mass values.

Table 2: Standard masses for passengers — aircraft with a total number of passenger seats of 19 or less

Passenger seats:	1 - 5	6 - 9	10 - 19
Male	104 kg	96 kg	92 kg
Female	86 kg	78 kg	74 kg
Children	35 kg	35 kg	35 kg

- (1) On aeroplane flights with 19 passenger seats or less and all helicopter flights where no hand baggage is carried in the cabin or where hand baggage is accounted for separately, 6 kg may be deducted from male and female masses in Table 2. Articles such as an overcoat, an umbrella, a small handbag or purse, reading material or a small camera are not considered as hand baggage.
  - (2) For helicopter operations in which a survival suit is provided to passengers, 3 kg should be added to the passenger mass value.
- (d) Mass values for baggage
- (1) Aeroplanes. When the total number of passenger seats available on the aeroplane is 20 or more, the standard mass values for checked baggage of Table 3 should be used.
  - (2) Helicopters. When the total number of passenger seats available on the helicopters is 20 or more, the standard mass value for checked baggage should be 13 kg.
  - (3) For aircraft with 19 passenger seats or less, the actual mass of checked baggage should be determined by weighing.

Table 3: Standard masses for baggage — aeroplanes with a total number of passenger seats of 20 or more

Type of flight	Baggage standard mass
Domestic	11 kg
Intercontinental	15 kg
All other	13 kg

- (4) For the purpose of Table 3:
- (i) domestic flight means a flight with origin and destination within the borders of one State;
  - (ii) intercontinental flight means flights beyond the European region with origin and destination in different continents.
- (e) Other standard masses may be used provided they are calculated on the basis of a detailed weighing survey plan and a reliable statistical analysis method is applied. The operator should advise the competent authority about the intent of the passenger weighing survey and explain the survey plan in general terms. The revised standard mass values should only be used in circumstances comparable with those under which the survey was conducted. Where the revised standard masses exceed those in Tables 1, 2 and 3 of, then such higher values should be used.
- (f) On any flight identified as carrying a significant number of passengers whose masses, including hand baggage, are expected to significantly deviate from the standard passenger mass, the operator should determine the actual mass of such passengers by weighing or by adding an adequate mass increment.
- (g) If standard mass values for checked baggage are used and a significant number of passengers checked baggage is expected to significantly deviate from the standard baggage mass, the operator should determine the actual mass of such baggage by weighing or by adding an adequate mass increment.

### **AMC2 CAT.POL.MAB.100(e) Mass and balance, loading**

#### **PROCEDURE FOR ESTABLISHING REVISED STANDARD MASS VALUES FOR PASSENGERS AND BAGGAGE**

- (a) Passengers
- (1) Weight sampling method. The average mass of passengers and their hand baggage should be determined by weighing, taking random samples. The selection of random samples should by nature and extent be representative of the passenger volume, considering the type of operation, the frequency of flights on various routes, in/outbound flights, applicable season and seat capacity of the aircraft.
  - (2) Sample size. The survey plan should cover the weighing of at least the greatest of:
    - (i) a number of passengers calculated from a pilot sample, using normal statistical procedures and based on a relative confidence range (accuracy) of 1 % for all adult and 2 % for separate male and female average masses; and

- (ii) for aircraft:
  - (A) with a passenger seating capacity of 40 or more, a total of 2 000 passengers; or
  - (B) with a passenger seating capacity of less than 40, a total number of 50 multiplied by the passenger seating capacity.
- (3) Passenger masses. Passenger masses should include the mass of the passengers' belongings that are carried when entering the aircraft. When taking random samples of passenger masses, infants should be weighted together with the accompanying adult.
- (4) Weighing location. The location for the weighing of passengers should be selected as close as possible to the aircraft, at a point where a change in the passenger mass by disposing of or by acquiring more personal belongings is unlikely to occur before the passengers board the aircraft.
- (5) Weighing machine. The weighing machine used for passenger weighing should have a capacity of at least 150 kg. The mass should be displayed at minimum graduations of 500 g. The weighing machine should have an accuracy of at least 0.5 % or 200 g, whichever is greater.
- (6) Recording of mass values. For each flight included in the survey the mass of the passengers, the corresponding passenger category (i.e. male/female/children) and the flight number should be recorded.
- (b) Checked baggage. The statistical procedure for determining revised standard baggage mass values based on average baggage masses of the minimum required sample size should comply with (a)(1) and (a)(2). For baggage, the relative confidence range (accuracy) should amount to 1 %. A minimum of 2 000 pieces of checked baggage should be weighed.
- (c) Determination of revised standard mass values for passengers and checked baggage
  - (1) To ensure that, in preference to the use of actual masses determined by weighing, the use of revised standard mass values for passengers and checked baggage does not adversely affect operational safety, a statistical analysis should be carried out. Such an analysis should generate average mass values for passengers and baggage as well as other data.
  - (2) On aircraft with 20 or more passenger seats, these averages apply as revised standard male and female mass values.
  - (3) On aircraft with 19 passenger seats or less, the increments in Table 1 should be added to the average passenger mass to obtain the revised standard mass values.

Table 1: Increments for revised standard masses values

Number of passenger seats	Required mass increment
1 – 5 incl.	16 kg
6 – 9 incl.	8 kg
10 – 19 incl.	4 kg

Alternatively, all adult revised standard (average) mass values may be applied on aircraft with 30 or more passenger seats. Revised standard (average) checked baggage mass values are applicable to aircraft with 20 or more passenger seats.

- (4) The revised standard masses should be reviewed at intervals not exceeding 5 years.
- (5) All adult revised standard mass values should be based on a male/female ratio of 80/20 in respect of all flights except holiday charters that are 50/50. A different ratio on specific routes or flights may be used, provided supporting data shows that the alternative male/female ratio is conservative and covers at least 84 % of the actual male/female ratios on a sample of at least 100 representative flights.
- (6) The resulting average mass values should be rounded to the nearest whole number in kg. Checked baggage mass values should be rounded to the nearest 0.5 kg figure, as appropriate.
- (7) When operating on similar routes or networks, operators may pool their weighing surveys provided that in addition to the joint weighing survey results, results from individual operators participating in the joint survey are separately indicated in order to validate the joint survey results.

### **GM1 CAT.POL.MAB.100(e) Mass and balance, loading**

#### ADJUSTMENT OF STANDARD MASSES

When standard mass values are used, AMC1 CAT.POL.MAB.100(e) subparagraph (g) states that the operator should identify and adjust the passenger and checked baggage masses in cases where significant numbers of passengers or quantities of baggage are suspected of significantly deviating from the standard values. Therefore, the operations manual should contain instructions to ensure that:

- (a) check-in, operations and cabin staff and loading personnel report or take appropriate action when a flight is identified as carrying a significant number of passengers whose masses, including hand baggage, are expected to significantly deviate from the standard passenger mass, and/or groups of passengers carrying exceptionally heavy baggage (e.g. military personnel or sports teams); and
- (b) on small aircraft, where the risks of overload and/or CG errors are the greatest, pilots pay special attention to the load and its distribution and make proper adjustments.

### **GM2 CAT.POL.MAB.100(e) Mass and Balance, Loading**

#### STATISTICAL EVALUATION OF PASSENGERS AND BAGGAGE DATA

- (a) Sample size
  - (1) For calculating the required sample size, it is necessary to make an estimate of the standard deviation on the basis of standard deviations calculated for similar populations or for preliminary surveys. The precision of a sample estimate is calculated for 95 % reliability or 'significance', i.e. there is a 95 % probability that the true value falls within the specified confidence interval around the estimated value. This standard deviation value is also used for calculating the standard passenger mass.
  - (2) As a consequence, for the parameters of mass distribution, i.e. mean and standard deviation, three cases have to be distinguished:
    - (i)  $\mu$ ,  $\sigma$  = the true values of the average passenger mass and standard deviation, which are unknown and which are to be estimated by weighing passenger samples.
    - (ii)  $\mu'$ ,  $\sigma'$  = the 'a priori' estimates of the average passenger mass and the standard deviation, i.e. values resulting from an earlier survey, which are needed to determine the current sample size.
    - (iii)  $x$ ,  $s$  = the estimates for the current true values of  $m$  and  $s$ , calculated from the sample.

(iv) The sample size can then be calculated using the following formula:

$$n \geq \frac{(1.96 * \sigma' * 100)^2}{(e'_r * \mu')^2}$$

where:

$n$  = number of passengers to be weighed (sample size)

$e'_r$  = allowed relative confidence range (accuracy) for the estimate of  $\mu$  by (see also equation in (c)). The allowed relative confidence range specifies the accuracy to be achieved when estimating the true mean. For example, if it is proposed to estimate the true mean to within  $\pm 1\%$ , then  $e'_r$  will be 1 in the above formula.

1.96 = value from the Gaussian distribution for 95 % significance level of the resulting confidence interval.

(b) Calculation of average mass and standard deviation. If the sample of passengers weighed is drawn at random, then the arithmetic mean of the sample ( $\bar{x}$ ) is an unbiased estimate of the true average mass ( $\mu$ ) of the population.

(1) Arithmetic mean of sample where:

$$\bar{x} = \frac{\sum_{j=1}^n x_j}{n}$$

$x_j$  = mass values of individual passengers (sampling units).

(2) Standard deviation where:

$$s = \sqrt{\frac{\sum_{j=1}^n (x_j - \bar{x})^2}{n - 1}}$$

$(x_j - \bar{x})$  = deviation of the individual value from the sample mean.

(c) Checking the accuracy of the sample mean. The accuracy (confidence range) which can be ascribed to the sample mean as an indicator of the true mean is a function of the standard deviation of the sample which has to be checked after the sample has been evaluated. This is done using the formula:

$$e_r = \frac{1.96 * s * 100}{\sqrt{n} * \bar{x}} (\%)$$

whereby  $e_r$  should not exceed 1 % for an all adult average mass and 2 % for an average male and/or female mass. The result of this calculation gives the relative accuracy of the estimate of  $\mu$  at the 95 % significance level. This means that with 95 % probability, the true average mass  $\mu$  lies within the interval:

$$\bar{x} \pm \frac{1.96 * s}{\sqrt{n}}$$

(d) Example of determination of the required sample size and average passenger mass

- (1) Introduction. Standard passenger mass values for mass and balance purposes require passenger weighing programs to be carried out. The following example shows the various steps required for establishing the sample size and evaluating the sample data. It is provided primarily for those who are not well versed in statistical computations. All mass figures used throughout the example are entirely fictitious.
- (2) Determination of required sample size. For calculating the required sample size, estimates of the standard (average) passenger mass and the standard deviation are needed. The 'a priori' estimates from an earlier survey may be used for this purpose. If such estimates are not available, a small representative sample of about 100 passengers should be weighed so that the required values can be calculated. The latter has been assumed for the example.

Step 1: Estimated average passenger mass.

n	x <sub>j</sub> (kg)
1	79.9
2	68.1
3	77.9
4	74.5
5	54.1
6	62.2
7	89.3
8	108.7
.	.
85	63.2
86	75.4
$\sum_{j=1}^{86}$	— 6 071.6

$$\mu' = \bar{x} = \frac{\sum x_j}{n} = \frac{6071.6}{86}$$

$$= 70.6 \text{ kg}$$

Step 2: Estimated standard deviation.

n	x <sub>j</sub>	(x <sub>j</sub> - )	(x <sub>j</sub> - ) <sup>2</sup>
1	79.9	+9.3	86.49
2	68.1	-2.5	6.25
3	77.9	+7.3	53.29
4	74.5	+3.9	15.21
5	54.1	-16.5	272.25
6	62.2	-8.4	70.56

7	89.3	+18.7	349.69
8	108.7	+38.1	1 451.61
.	.	.	.
85	63.2	-7.4	54.76
86	75.4	-4.8	23.04
$\sum_{j=1}^{86}$	6 071.6		34 683.40

$$\sigma' = \sqrt{\frac{\sum (x_j - \bar{x})^2}{n-1}}$$

$$\sigma' = \sqrt{\frac{34\,683.40}{86-1}}$$

$$\sigma' = 20.20 \text{ kg}$$

Step 3: Required sample size.

The required number of passengers to be weighed should be such that the confidence range e'r does not exceed 1 %, as specified in (c).

$$n \geq \frac{(1.96 * \sigma' * 100)^2}{(e'_r * \mu')^2}$$

$$n \geq \frac{(1.96 * 20.20 * 100)^2}{(1 * 70.6)^2}$$

$$n \geq 3145$$

The result shows that at least 3 145 passengers should be weighed to achieve the required accuracy. If e'r is chosen as 2 % the result would be n ≥786.

Step 4: After having established the required sample size, a plan for weighing the passengers is to be worked out.

(3) Determination of the passenger average mass

Step 1: Having collected the required number of passenger mass values, the average passenger mass can be calculated. For the purpose of this example, it has been assumed that 3 180 passengers were weighed. The sum of the individual masses amounts to 231 186.2 kg.

$$n = 3\,180$$

$$\sum_{j=1}^{3180} X_j = 231\,186.2 \text{ kg}$$



$$\bar{x} = \frac{\sum x_j}{n} = \frac{231186.2}{3180} \text{ kg}$$

$$\bar{x} = 72.7 \text{ kg}$$

Step 2: Calculation of the standard deviation

For calculating the standard deviation, the method shown in paragraph (2) step 2 should be applied.

$$\sum (x_j - \bar{x})^2 = 745\,145.20$$

$$s = \sqrt{\frac{\sum (x_j - \bar{x})^2}{n - 1}}$$

$$s = \sqrt{\frac{745\,145.20}{3180 - 1}}$$

$$s = 15.31 \text{ kg}$$

Step 3: Calculation of the accuracy of the sample mean

$$e_r = \frac{1.96 * s * 100}{\sqrt{n} * \bar{x}} \%$$

$$e_r = \frac{1.96 * 15.31 * 100}{\sqrt{3180} * 72.7} \%$$

$$e_r = 0.73 \%$$

Step 4: Calculation of the confidence range of the sample mean

$$\bar{x} \pm \frac{1.96 * s}{\sqrt{n}}$$

$$\bar{x} \pm \frac{1.96 * 15.31}{\sqrt{3180}} \text{ kg}$$

$$72.7 \pm 0.5 \text{ kg}$$

The result of this calculation shows that there is a 95 % probability of the actual mean for all passengers lying within the range

$$72.2 \text{ kg to } 73.2 \text{ kg.}$$

**GM3 CAT.POL.MAB.100(e) Mass and balance, loading****GUIDANCE ON PASSENGER WEIGHING SURVEYS**

- (a) Detailed survey plan
  - (1) The operator should establish and submit to the competent authority a detailed weighing survey plan that is fully representative of the operation, i.e. the network or route under consideration and the survey should involve the weighing of an adequate number of passengers.
  - (2) A representative survey plan means a weighing plan specified in terms of weighing locations, dates and flight numbers giving a reasonable reflection of the operator's timetable and/or area of operation.
  - (3) The minimum number of passengers to be weighed is the highest of the following:
    - (i) The number that follows from the means of compliance that the sample should be representative of the total operation to which the results will be applied; this will often prove to be the overriding requirement.
    - (ii) The number that follows from the statistical requirement specifying the accuracy of the resulting mean values, which should be at least 2 % for male and female standard masses and 1 % for all adult standard masses, where applicable. The required sample size can be estimated on the basis of a pilot sample (at least 100 passengers) or from a previous survey. If analysis of the results of the survey indicates that the requirements on the accuracy of the mean values for male or female standard masses or all adult standard masses, as applicable, are not met, an additional number of representative passengers should be weighed in order to satisfy the statistical requirements.
  - (4) To avoid unrealistic ally small samples, a minimum sample size of 2 000 passengers (males + females) is also required, except for small aircraft where in view of the burden of the large number of flights to be weighed to cover 2 000 passengers, a lesser number is considered acceptable.
- (b) Execution of weighing programme
  - (1) At the beginning of the weighing programme, it is important to note, and to account for, the data requirements of the weighing survey report (see (e)).
  - (2) As far as is practicable, the weighing programme should be conducted in accordance with the specified survey plan.
  - (3) Passengers and all their personal belongings should be weighed as close as possible to the boarding point and the mass, as well as the associated passenger category (male/female/child), should be recorded.
- (c) Analysis of results of weighing survey. The data of the weighing survey should be analysed as explained in this GM. To obtain an insight to variations per flight, per route, etc. this analysis should be carried out in several stages, i.e. by flight, by route, by area, inbound/outbound, etc. Significant deviations from the weighing survey plan should be explained as well as their possible effect(s) on the results.
- (d) Results of the weighing survey

- (1) The results of the weighing survey should be summarised. Conclusions and any proposed deviations from published standard mass values should be justified. The results of a passenger weighing survey are average masses for passengers, including hand baggage, which may lead to proposals to adjust the standard mass values given in AMC1 CAT.POL.MAB.100(e) Tables 1 and 2. These averages, rounded to the nearest whole number may, in principle, be applied as standard mass values for males and females on aircraft with 20 or more passenger seats. Because of variations in actual passenger masses, the total passenger load also varies and statistical analysis indicates that the risk of a significant overload becomes unacceptable for aircraft with less than 20 seats. This is the reason for passenger mass increments on small aircraft.
  - (2) The average masses of males and females differ by some 15 kg or more. Because of uncertainties in the male/female ratio, the variation of the total passenger load is greater if all adult standard masses are used than when using separate male and female standard masses. Statistical analysis indicates that the use of all adult standard mass values should be limited to aircraft with 30 passenger seats or more.
  - (3) Standard mass values for all adults must be based on the averages for males and females found in the sample, taking into account a reference male/female ratio of 80/20 for all flights except holiday charters where a ratio of 50/50 applies. The operator may, based on the data from his weighing programme, or by proving a different male/female ratio, apply for approval of a different ratio on specific routes or flights.
- (e) Weighing survey report
- The weighing survey report, reflecting the content of (d)(1) - (3), should be prepared in a standard format as follows:

#### WEIGHING SURVEY REPORT

---

##### **1** Introduction

Objective and brief description of the weighing survey.

---

##### **2** Weighing survey plan

Discussion of the selected flight number, airports, dates, etc.

Determination of the minimum number of passengers to be weighed.

Survey plan.

---

##### **3** Analysis and discussion of weighing survey results

Significant deviations from survey plan (if any).

Variations in means and standard deviations in the network.

Discussion of the (summary of) results.

---

##### **4** Summary of results and conclusions

Main results and conclusions.

Proposed deviations from published standard mass values.

---

##### Attachment 1

Applicable summer and/or winter timetables or flight programmes.

---

## Attachment 2

Weighing results per flight (showing individual passenger masses and sex); means and standard deviations per flight, per route, per area and for the total network.

**GM1 CAT.POL.MAB.100(g) Mass and balance, loading**

## FUEL DENSITY

- (a) If the actual fuel density is not known, the operator may use standard fuel density values for determining the mass of the fuel load. Such standard values should be based on current fuel density measurements for the airports or areas concerned.
- (b) Typical fuel density values are:

(1)	Gasoline (piston engine fuel)	0.71
(2)	JET A1 (Jet fuel JP 1)	0.79
(3)	JET B (Jet fuel JP 4)	0.76
(4)	Oil	0.88

**GM1 CAT.POL.MAB.100(i) Mass and balance, loading**

## IN- FLIGHT CHANGES IN LOADING — HELICOPTERS

In-flight changes in loading may occur in hoist operations.

**AMC1 CAT.POL.MAB.105(a) Mass and balance data and documentation**

## CONTENTS

The mass and balance documentation should include advice to the commander whenever a non- standard method has been used for determining the mass of the load.

**AMC1 CAT.POL.MAB.105(b) Mass and balance data and documentation**

## INTEGRITY

The operator should verify the integrity of mass and balance data and documentation generated by a computerised mass and balance system, at intervals not exceeding 6 months. The operator should establish a system to check that amendments of its input data are incorporated properly in the system and that the system is operating correctly on a continuous basis.

**AMC1 CAT.POL.MAB.105(c) Mass and balance data and documentation**

## SIGNATURE OR EQUIVALENT

Where a signature by hand is impracticable or it is desirable to arrange the equivalent verification by electronic means, the following conditions should be applied in order to make an electronic signature the equivalent of a conventional hand-written signature:

- (a) electronic 'signing' by entering a personal identification number (PIN) code with appropriate security, etc.;
- (b) entering the PIN code generates a print-out of the individual's name and professional capacity on the relevant document(s) in such a way that it is evident, to anyone having a need for that information, who has signed the document;
- (c) the computer system logs information to indicate when and where each PIN code has been entered;

- (d) the use of the PIN code is, from a legal and responsibility point of view, considered to be fully equivalent to signature by hand;
- (e) the requirements for record keeping remain unchanged; and
- (f) all personnel concerned are made aware of the conditions associated with electronic signature and this is documented.

**AMC2 CAT.POL.MAB.105(c) Mass and balance data and documentation****MASS AND BALANCE DOCUMENTATION SENT VIA DATA LINK**

Whenever the mass and balance documentation is sent to the aircraft via data link, a copy of the final mass and balance documentation, as accepted by the commander, should be available on the ground.

**GM1 CAT.POL.MAB.105(e) Mass and balance data and documentation****ON-BOARD INTEGRATED MASS AND BALANCE COMPUTER SYSTEM.**

An on-board integrated mass and balance computer system may be an aircraft installed system capable of receiving input data either from other aircraft systems or from a mass and balance system on ground, in order to generate mass and balance data as an output.

**GM2 CAT.POL.MAB.105(e) Mass and balance data and documentation****STAND- ALONE COMPUTERISED MASS AND BALANCE SYSTEM**

A stand-alone computerised mass and balance system may be a computer, either as a part of an electronic flight bag (EFB) system or solely dedicated to mass and balance purposes, requiring input from the user, in order to generate mass and balance data as an output.

## **SECTION 4 — Sailplanes**

**Reserved**

## **SECTION 5 — Balloons**

Reserved

## **SUBPART D — Instrument, data, equipment**

### **SECTION 1 — Aeroplanes**

#### **GM1 CAT.IDE.A.100(a) Instruments and equipment — general**

REQUIRED INSTRUMENTS AND EQUIPMENT THAT DO NOT NEED TO BE APPROVED

The functionality of non-installed instruments and equipment required by this Subpart and that do not need an equipment approval, as listed in CAT.IDE.A.100(a), should be checked against recognised industry standards appropriate to the intended purpose. The operator is responsible for ensuring the maintenance of these instruments and equipment.

#### **GM1 CAT.IDE.A.100(b) Instruments and equipment — general**

NOT REQUIRED INSTRUMENTS AND EQUIPMENT THAT DO NOT NEED TO BE APPROVED

- (a) The provision of this paragraph does not exempt any installed instrument or item of equipment from complying with LCAR's. In this case, the installation should be approved as required and should comply with the applicable airworthiness codes as required under the same Regulation.
- (b) The failure of additional non- installed instruments or equipment not required by this Part or any applicable airspace requirements should not adversely affect the airworthiness and/or the safe operation of the aeroplane. Examples may be the following:
  - (1) portable electronic flight bag (EFB);
  - (2) portable electronic devices carried by flight crew or cabin crew; and
  - (3) non- installed passenger entertainment equipment.

#### **GM1 CAT.IDE.A.100(d) Instruments and equipment — general**

POSITIONING OF INSTRUMENTS

This requirement implies that whenever a single instrument is required to be installed in an aeroplane operated in a multi-crew environment, the instrument needs to be visible from each flight crew station.

#### **GM1 CAT.IDE.A.110 Spare electrical fuses**

FUSES

A 'spare electrical fuse' means a replaceable fuse in the flight crew compartment, not an automatic circuit breaker, or circuit breakers in the electric compartments.

#### **AMC1 CAT.IDE.A.120 Equipment to clear windshield**

MEANS TO MAINTAIN A CLEAR PORTION OF THE WINDSHIELD DURING PRECIPITATION

The means used to maintain a clear portion of the windshield during precipitation should be windshield wipers or an equivalent.

#### **AMC1 CAT.IDE.A.125 & CAT.IDE.A.130 Operations under VFR by day & Operations under IFR or at night — flight and navigational instruments and associated equipment**

INTEGRATED INSTRUMENTS



- (a) Individual equipment requirements may be met by combinations of instruments, by integrated flight systems or by a combination of parameters on electronic displays, provided that the information so available to each required pilot is not less than that required in the applicable operational requirements, and the equivalent safety of the installation has been shown during type certification approval of the aeroplane for the intended type of operation.
- (b) The means of measuring and indicating turn and slip, aeroplane attitude and stabilised aeroplane heading may be met by combinations of instruments or by integrated flight director systems, provided that the safeguards against total failure, inherent in the three separate instruments, are retained.

## **AMC2 CAT.IDE.A.125 Operations under VFR by day — flight and navigational instruments and associated equipment**

### LOCAL FLIGHTS

For flights that do not exceed 60 minutes' duration, that take off and land at the same aerodrome and that remain within 50 NM of that aerodrome, an equivalent means of complying with CAT.IDE.A.125 (a)(1)(vi) may be:

- (a) a turn and slip indicator;
- (b) a turn coordinator; or
- (c) both an attitude indicator and a slip indicator.

## **AMC1 CAT.IDE.A.125(a)(1)(i) & CAT.IDE.A.130(a)(1) Operations under VFR by day & Operations under IFR or at night — flight and navigational instruments and associated equipment**

### MEANS OF MEASURING AND DISPLAYING MAGNETIC HEADING

The means of measuring and displaying magnetic direction should be a magnetic compass or equivalent.

## **AMC1 CAT.IDE.A.125(a)(1)(ii) & CAT.IDE.A.130(a)(2) Operations under VFR by day & Operations under IFR or at night — flight and navigational instruments and associated equipment**

### MEANS OF MEASURING AND DISPLAYING THE TIME

An acceptable means of compliance is a clock displaying hours, minutes and seconds, with a sweep-second pointer or digital presentation.

## **AMC1 CAT.IDE.A.125(a)(1)(iii) & CAT.IDE.A.130(b) Operations under VFR by day & Operations under IFR or at night — flight and navigational instruments and associated equipment**

### CALIBRATION OF THE MEANS OF MEASURING AND DISPLAYING PRESSURE ALTITUDE

The instrument measuring and displaying pressure altitude should be of a sensitive type calibrated in feet (ft), with a sub-scale setting, calibrated in hectopascals/millibars, adjustable for any barometric pressure likely to be set during flight.

## **AMC1 CAT.IDE.A.125(a)(1)(iv) & CAT.IDE.A.130(a)(3) Operations under VFR by day & Operations under IFR or at night — flight and navigational instruments and associated equipment**

### CALIBRATION OF THE INSTRUMENT INDICATING AIRSPEED

The instrument indicating airspeed should be calibrated in knots (kt).

**AMC1 CAT.IDE.A.130(a)(5) Operations under IFR or at night — flight and navigational instruments and associated equipment**

## SLIP INDICATOR

If only slip indication is provided, the means of measuring and displaying standby attitude should be certified according to CS 25.1303(b)(4) or equivalent.

**AMC2 CAT.IDE.A.130(b) Operations under IFR or at night — flight and navigational instruments and associated equipment**

## ALTIMETERS — IFR OR NIGHT OPERATIONS

Except for unpressurised aeroplanes operating below 10 000 ft, the altimeters of aeroplanes operating under IFR or at night should have counter drum-pointer or equivalent presentation.

**AMC1 CAT.IDE.A.125(a)(1)(ix) & CAT.IDE.A.130(a)(8) Operations under VFR by day & operations under IFR or at night — flight and navigational instruments and associated equipment**

## MEANS OF DISPLAYING OUTSIDE AIR TEMPERATURE

- (a) The means of displaying outside air temperature should be calibrated in degrees Celsius.
- (b) The means of displaying outside air temperature may be an air temperature indicator that provides indications that are convertible to outside air temperature.

**AMC1 CAT.IDE.A.125(b) & CAT.IDE.A.130(h) Operations under VFR by day & Operations under IFR or at night — flight and navigational instruments and associated equipment**

## MULTI- PILOT OPERATIONS — DUPLICATE INSTRUMENTS

Duplicate instruments should include separate displays for each pilot and separate selectors or other associated equipment where appropriate.

**AMC1 CAT.IDE.A.125(c) & CAT.IDE.A.130(d) Operations under VFR by day & Operations under IFR or at night — flight and navigational instruments and associated equipment**

## MEANS OF PREVENTING MALFUNCTION DUE TO CONDENSATION OR ICING

The means of preventing malfunction due to either condensation or icing of the airspeed indicating system should be a heated pitot tube or equivalent.

**AMC1 CAT.IDE.A.130(e) Operations under IFR or at night — flight and navigational instruments and associated equipment**

## MEANS OF INDICATING FAILURE OF THE AIRSPEED INDICATING SYSTEM'S MEANS OF PREVENTING MALFUNCTION DUE TO EITHER CONDENSATION OR ICING

A combined means of indicating failure of the airspeed indicating system's means of preventing malfunction due to either condensation or icing is acceptable provided that it is visible from each flight crew station and that there is a means to identify the failed heater in systems with two or more sensors.

**AMC1 CAT.IDE.A.130(i)(5) Operations under IFR or at night — flight and navigational instruments and associated equipment**

## ILLUMINATION OF STANDBY MEANS OF MEASURING AND DISPLAYING ATTITUDE

The standby means of measuring and displaying attitude should be illuminated so as to be clearly visible under all conditions of daylight and artificial lighting.

**AMC1 CAT.IDE.A.130(j) Operations under IFR or at night — flight and navigational instruments and associated equipment**

## CHART HOLDER

An acceptable means of compliance with the chart holder requirement is to display a pre-composed chart on an electronic flight bag (EFB).

**GM1 CAT.IDE.A.125 & CAT.IDE.A.130 Operations under VFR by day & Operations under IFR or at night — flight and navigational instruments and associated equipment**

## SUMMARY TABLE

Table 1: Flight and navigational instruments and associated equipment

SERIAL		FLIGHTS UNDER VFR		FLIGHTS UNDER IFR OR AT NIGHT	
		SINGLE-PILOT	TWO PILOTS REQUIRED	SINGLE-PILOT	TWO PILOTS REQUIRED
(a)		(b)	(c)	(d)	(e)
1	Magnetic direction	1	1	1	1
2	Time	1	1	1	1
3	Pressure altitude	1	2	2 Note (5)	2 Note (5)
4	Indicated airspeed	1	2	1	2
5	Vertical speed	1	2	1	2
6	Turn and slip or turn coordinator	1 Note (1)	2 Note (1) & Note (2)	1 Note (4)	2 Note (4)
7	Attitude	1 Note (1)	2 Note (1) & Note (2)	1	2
8	Stabilised direction	1 Note (1)	2 Note (1) & Note (2)	1	2
9	Outside temperature air	1	1	1	1
10	Mach number indicator	See Note (3)			

11	Airspeed protection icing	1 Note (6)	2 Note (6)	1	2
12	Airspeed protection indicating icing failure			1 Note (7)	2 Note (7)
13	Static pressure source			2	2
14	Standby attitude indicator			1 Note (8)	1 Note (8)
15	Chart holder			1 Note (6)	1 Note (6)

*Note (1) For local flights (A to A, 50 NM radius, not more than 60 minutes' duration), the instruments at serials (a)(6) and (a)(8) may be replaced by either a turn and slip indicator, or a turn coordinator, or both an attitude indicator and a slip indicator.*

*Note (2) The substitute instruments permitted by Note (1) above should be provided at each pilot's station.*

*Note (3) A Mach number indicator is required for each pilot whenever compressibility limitations are not otherwise indicated by airspeed indicators.*

*Note (4) For IFR or at night, a turn and slip indicator, or a slip indicator and a third (standby) attitude indicator certified according to CS 25.1303 (b)(4) or equivalent, is required.*

*Note (5) Except for unpressurised aeroplanes operating below 10 000 ft, neither three pointers, nor drum-pointer altimeters satisfy the requirement.*

*Note (6) Applicable only to aeroplanes with a maximum certified take-off mass (MC TOM) of more than 5 700 kg, or with an MOPSC of more than 9. It also applies to all aeroplanes first issued with an individual certificate of airworthiness (CofA) on or after 1 April 1999.*

*Note (7) The pitot heater failure annunciation applies to any aeroplane issued with an individual CofA on or after 1 April 1998. It also applies before that date when: the aeroplane has an MCTOM of more than 5 700 kg and an MOPSC greater than 9.*

*Note (8) Applicable only to aeroplanes with an MCTOM of more than 5 700 kg, or with an MPSC/MOPSC of more than 9.*

### **AMC1 CAT.IDE.A.150 Terrain awareness warning system (TAWS)**

#### **EXCESSIVE DOWNWARDS GLIDE SLOPE DEVIATION WARNING FOR CLASS A TAWS**

The requirement for a Class A TAWS to provide a warning to the flight crew for excessive downwards glide slope deviation should apply to all final approach glide slopes with angular vertical navigation (VNAV) guidance, whether provided by the instrument landing system (ILS), microwave landing system (MLS), satellite based augmentation system approach procedure with vertical guidance (SBAS APV (localiser performance with vertical guidance approach LPV)), ground-based augmentation system (GBAS (GPS landing system, GLS) or any other systems providing similar guidance. The same requirement should not apply to systems providing vertical guidance based on barometric VNAV.

**GM1 CAT.IDE.A.150 Terrain awareness warning system (TAWS)**

## ACCEPTABLE STANDARD FOR TAWS

An acceptable standard for Class A and Class B TAWS may be the applicable European technical standards order (ETSO) issued by the Agency or equivalent.

**AMC1 CAT.IDE.A.160 Airborne weather detecting equipment**

## GENERAL

The airborne weather detecting equipment should be an airborne weather radar, except for propeller-driven pressurised aeroplanes with an MCTOM not more than 5 700 kg and an MOPSC of not more than 9, for which other equipment capable of detecting thunderstorms and other potentially hazardous weather conditions, regarded as detectable with airborne weather radar equipment, are also acceptable.

**AMC1 CAT.IDE.A.170 Flight crew interphone system**

## TYPE OF FLIGHT CREW INTERPHONE

The flight crew interphone system should not be of a handheld type.

**AMC1 CAT.IDE.A.175 Crew member interphone system**

## SPECIFICATIONS

The crew member interphone system should:

- (a) operate independently of the public address system except for handsets, headsets, microphones, selector switches and signalling devices;
- (b) in the case of aeroplanes where at least one cabin crew member is required, be readily accessible for use at required cabin crew member stations close to each separate or pair of floor level emergency exits;
- (c) in the case of aeroplanes where at least one cabin crew member is required, have an alerting system incorporating aural or visual signals for use by flight and cabin crew;
- (d) have a means for the recipient of a call to determine whether it is a normal call or an emergency call that uses one or a combination of the following:
  - (1) lights of different colours;
  - (2) codes defined by the operator (e.g. different number of rings for normal and emergency calls); or
  - (3) any other indicating signal specified in the operations manual;
- (e) provide two-way communication between:
  - (1) the flight crew compartment and each passenger compartment, in the case of aeroplanes where at least one cabin crew member is required;
  - (2) the flight crew compartment and each galley located other than on a passenger deck level, in the case of aeroplanes where at least one cabin crew member is required;
  - (3) the flight crew compartment and each remote crew compartment and crew member station that is not on the passenger deck and is not accessible from a passenger compartment; and
  - (4) ground personnel and at least two flight crew members. This interphone system for use by the ground personnel should be, where practicable, so located that the personnel using the system may avoid detection from within the aeroplane; and
- (f) be readily accessible for use from each required flight crew station in the flight crew compartment.

**AMC1 CAT.IDE.A.180 Public address system**

## SPECIFICATIONS

The public address system should:

- (a) operate independently of the interphone systems except for handsets, headsets, microphones, selector switches and signalling devices;
- (b) be readily accessible for immediate use from each required flight crew station;
- (c) have, for each floor level passenger emergency exit that has an adjacent cabin crew seat, a microphone operable by the seated cabin crew member, except that one microphone may serve more than one exit, provided the proximity of exits allows unassisted verbal communication between seated cabin crew members;
- (d) be operable within 10 seconds by a cabin crew member at each of those stations; and
- (e) be audible at all passenger seats, lavatories, galleys, cabin crew seats and work stations, and other crew remote areas.

**AMC1 CAT.IDE.A.185 Cockpit voice recorder**

## OPERATIONAL PERFORMANCE REQUIREMENTS

- (a) For aeroplanes first issued with an individual CofA on or after 1 April 1998 and before 1 January 2016, the operational performance requirements for cockpit voice recorders (CVRs) and their dedicated equipment should be those laid down in the European Organisation for Civil Aviation Equipment (EUROCAE) Document ED-56A (Minimum Operational Performance Requirements For Cockpit Voice Recorder Systems) dated December 1993, or EUROCAE Document ED-112 (Minimum Operational Performance Specification for Crash Protected Airborne Recorder Systems) dated March 2003, including Amendments No 1 and No 2, or any later equivalent standard produced by EUROCAE.
- (b) For aeroplanes first issued with an individual C of A on or after 1 January 2016;
  - (1) the operational performance requirements for CVRs should be those laid down in EUROCAE Document ED-112 (Minimum Operational Performance Specification for Crash Protected Airborne Recorder Systems) dated March 2003, including Amendments No 1 and No 2, or any later equivalent standard produced by EUROCAE; and
  - (2) the operational performance requirements for equipment dedicated to the CVR should be those laid down in the European Organisation for Civil Aviation Equipment (EUROCAE) Document ED-56A (Minimum Operational Performance Requirements For Cockpit Voice Recorder Systems) dated December 1993, or EUROCAE Document ED-112 (Minimum Operational Performance Specification for Crash Protected Airborne Recorder Systems) dated March 2003, including Amendments n°1 and n°2 , or any later equivalent standard produced by EUROCAE.

**AMC1 CAT.IDE.A.190 Flight data recorder**

## OPERATIONAL PERFORMANCE REQUIREMENTS FOR AEROPLANES FIRST ISSUED WITH AN INDIVIDUAL COFA ON OR AFTER 1 JANUARY 2016

- (a) The operational performance requirements for flight data recorders (FDRs) should be those laid down in EUROCAE Document ED-112 (Minimum Operational Performance Specification for Crash Protected Airborne Recorder Systems) dated March 2003, including amendments No 1 and No 2, or any later equivalent standard produced by EUROCAE.
- (b) The FDR should record with reference to a timescale the list of parameters in Table 1 and Table 2, as applicable.

- (c) The parameters to be recorded should meet the performance specifications (range, sampling intervals, accuracy limits and resolution in read-out) as defined in the relevant tables of EUROCAE Document ED-112, including amendments No 1 and No 2, or any later equivalent standard produced by EUROCAE.

Table 1: FDR — all aeroplanes

No*	Parameter
1a 1b 1c	Time; or Relative time count Global navigation satellite system (GNSS) time synchronisation
2	Pressure altitude
3a	Indicated airspeed; or Calibrated airspeed
4	Heading (primary flight crew reference) — when true or magnetic heading can be selected, the primary heading reference, a discrete indicating
5	Normal acceleration
6	Pitch attitude
7	Roll attitude
8	Manual radio transmission keying and CVR/FDR synchronization reference
9 9a 9b	Engine thrust/power Parameters required to determine propulsive thrust/power on each engine Flight crew compartment thrust/power lever position for aeroplanes with non- mechanically linked flight crew compartment — engine control
14	Total or outside air temperature
16	Longitudinal acceleration (body axis)
17	Lateral acceleration
18	Primary flight control surface and primary flight control pilot input (for multiple or split surfaces, a suitable combination of inputs is acceptable in lieu of recording each surface separately. For aeroplanes that have a flight control break-away capability that allows either pilot to operate the
18a 18b 18c	Pitch axis Roll axis Yaw axis
19	Pitch trim surface position
23	Marker beacon passage
24	Warnings — in addition to the master warning, each 'red' warning (including smoke warnings from other compartments) should be recorded when the warning condition cannot be determined from other parameters or
25	Each navigation receiver frequency selection
27	Air-ground status and a sensor of each landing gear if installed



75 75a 75b 75c	.	All flight control input forces (for fly-by-wire flight control systems, where control surface position is a function of the displacement of the control input device only, it is not necessary to record this parameter): Control wheel Controlcolumn Rudder pedal
-------------------------	---	--

\* The number in the left hand column reflects the serial number depicted in EUROCAE ED -112.

Table 2: FDR — Aeroplanes for which the data source for the parameter is either used by aeroplane systems or is available on the instrument panel for use by the flight crew to operate the aeroplane

No *	Parameter
10 10a 10b	Flaps Trailing edge flap position Flight crew compartment control selection
11 11a 11b	Slats Leading edge flap (slat) position Flight crew compartment control selection
12	Thrust reverse status
13 13a	Ground spoiler and speed brake Ground spoiler position
13b 13c 13d	Ground spoiler selection Speed brake position Speed brake selection
15	Autopilot, autothrottle and AFCS mode and engagement status
20	Radio altitude. For auto- land/Category III operations, each radio altimeter should be recorded.
21	Vertical deviation — the approach aid in use should be recorded. For auto-land/Category III operations, each system should be recorded.
21a 21b 21c	ILS/GPS/GLS glide path MLS elevation GNSS approach path/IRNAV vertical deviation

22	Horizontal deviation — the approach aid in use should be recorded. For auto land/Category III operations, each system should be recorded.
22a 22b 22c	22b ILS/GPS/GLS localiser MLS azimuth GNSS approach path/IRNAV lateral deviation
26 26a 26b	Distance measuring equipment (DME) 1 and 2 distances Distance to runway threshold (GLS) Distance to missed approach point (IRNAV/IAN)
28 28a 28b 28c	28b Ground proximity warning system (GPWS)/terrain awareness warning system (TAWS)/ground collision avoidance system(GCAS) status: Selection of terrain display mode, including pop- up display status Terrain alerts, including cautions and warnings and advisories On/off switch position
29	Angle of attack
30 30a 30b	Low pressure warning (each system): Hydraulic pressure Pneumatic pressure
31	Ground speed
32 32a 32b	Landing gear: Landing gear Gear selector position
33 33a 33b 33c 33d 33e 33f	Navigation data: Drift angle Wind speed Wind direction Latitude Longitude GNSS augmentation in use
34 34a 34b	Brakes: Left and right brake pressure Left and right brake pedal position

35 . .. 35a 35b 35c 35d 35e 335h	Additional engine parameters (if not already recorded in parameter 9 of Table 1 of AMC1 CAT.IDE.190.A, and if the aeroplane is equipped with a suitable data source): Engine pressure ratio (EPR) N1 Indicated vibration level N2 Exhaust gas temperature (EGT) Fuel flow Fuel cut-off lever position N3
36 36a 36b 36c 36d 36e	Traffic alert and collision avoidance system (TCAS)/airborne collision avoidance system (ACAS) — a suitable combination of discretely should be recorded to determine the status of the system: Combined control Vertical control Up advisory Down advisory Sensitivity level
37	Wind shear warning
38 38a 38b	Selected barometric setting Pilot selected barometric setting Co- pilot selected barometric setting
39	Selected altitude (all pilot selectable modes of operation) — to be recorded for the aeroplane where the parameter is displayed electronically
40	Selected speed (all pilot selectable modes of operation) — to be recorded for the aeroplane where the parameter is displayed electronically
41	Selected Mach (all pilot selectable modes of operation) — to be recorded for the aeroplane where the parameter is displayed electronically
42	Selected vertical speed (all pilot selectable modes of operation) — to be recorded for the aeroplane where the parameter is displayed electronically
43	Selected heading (all pilot selectable modes of operation) — to be recorded for the aeroplane where the parameter is displayed electronically
44 44a 44b 44c	Selected flight path (All pilot selectable modes of operation) — to be recorded for the aeroplane where the parameter is displayed electronically Course/desired track (DSTRK) Path angle Coordinates of final approach path (IRNAV/IAN)

45	Selected decision height — to be recorded for the aeroplane where the parameter is displayed electronically
46 46a 46b	Electronic flight instrument system(EFIS) display format: Pilot Co- pilot
47	Multi- function/engine/alerts display format
48	Alternating current (AC) electrical bus status — each bus
49	Direct current (DC) electrical bus status — each bus
50	Engine bleed valve position
51	Auxiliary power unit (APU) bleed valve position
52	Computer failure — (all critical flight and engine control systems)
53	Engine thrust command
54	Engine thrust target
55	Computed centre of gravity (CG)
56	Fuel quantity or fuel quantity in CG trim tank
57	Head up display in use
58	Para visual display on
59	Operational stall protection, stick shaker and pusher activation
60 60a 60b 60c 60d 60e 60f	Primary navigation system reference: GNSS Inertial navigational system(INS) VHF omnidirectional radio range (VOR)/distance measuring equipment (DME) MLS Loran C ILS
61	Ice detection
62	Engine warning — each engine vibration
63	Engine warning — each engine over temperature

64	Engine warning — each engine oil pressure low
65	Engine warning — each engine over speed
66	Yaw trim surface position
67	Roll trim surface position
68	Yaw or sideslip angle
69	De- icing and/or anti- icing systems selection
70	Hydraulic pressure — each system
71	Loss of cabin pressure
72	Flight crew compartment trim control input position pitch — when mechanical means for control inputs are not available, cockpit display trim positions or trim command should be recorded
73	Flight crew compartment trim control input position roll — when mechanical means for control inputs are not available, flight crew compartment display trim positions or trim command should be recorded
74	Flight crew compartment trim control input position yaw — when mechanical means for control inputs are not available, flight crew compartment display trim positions or trim command should be recorded.
76	Event marker
77	Date
78	Actual navigation performance (ANP) or estimate of position error (EPE) or estimate of position uncertainty (EPU)

\* The number in the left hand column reflects the serial number depicted in EUROCAE Document ED-112.

### **AMC2 CAT.IDE.A.190 Flight data recorder**

OPERATIONAL PERFORMANCE REQUIREMENTS FOR AEROPLANES FIRST ISSUED WITH AN INDIVIDUAL COFA ON OR AFTER 1 APRIL 1998 AND BEFORE 1 JANUARY 2016

- (a) The operational performance requirements for FDRs should be those laid down in EUROCAE Document ED- 55 (Minimum Operational Performance Requirements For Flight Data Recorder Systems) dated May 1990, or EUROCAE Document ED-112 (Minimum Operational Performance Specification for Crash Protected Airborne Recorder Systems) dated March 2003, including amendments No 1 and No 2, or any later equivalent standard produced by EUROCAE.
- (b) The FDR should record, with reference to a timescale:
  - (1) the parameters listed in Table 1a or Table 1b below, as applicable;

- (2) the additional parameters listed in Table 2 below, for those aeroplanes with an MCTOM exceeding 27 000 kg;
  - (3) any dedicated parameters relating to novel or unique design or operational characteristics of the aeroplane as determined by the competent authority; and
  - (4) the additional parameters listed in Table 3 below, for those aeroplanes equipped with electronic display systems.
- (c) When determined by the Agency, the FDR of aeroplanes first issued with an individual C of A before 20 August 2002 and equipped with an electronic display system does not need to record those parameters listed in Table 3 for which:
- (1) the sensor is not available;
  - (2) the aeroplane system or equipment generating the data needs to be modified; or
  - (3) the signals are incompatible with the recording system;
- (d) The FDR of aeroplanes first issued with an individual CofA on or after 1 April 1998 but not later than 1 April 2001 is not required to comply with (b) above if:
- (1) compliance with (a) cannot be achieved without extensive modification to the aeroplane system and equipment other than the flight recording system; and
  - (2) the FDR of the aeroplane can comply with AMC4 CAT.IDE.A.190(a) except that parameter 15b in Table 1 of AMC4 CAT.IDE.A.190 need not be recorded.
- (e) The parameters to be recorded should meet, as far as practicable, the performance specifications (ranges, sampling intervals, accuracy limits, and resolution in read-out) defined in Table 1 of AMC3 CAT.IDE.A.190.
- (f) For aeroplanes with novel or unique design or operational characteristics, the additional parameters should be those required in accordance with applicable Certification Specifications during type or supplemental certification or validation.
- (g) If recording capacity is available, as many as possible of the additional parameters specified in table II-A.1 of EUROCAE Document ED 112 dated March 2003 should be recorded.

Table 1a: FDR — Aeroplanes with an MCTOM of more than 5 700 kg

No	Parameter
1	Time or relative time count
2	Pressure altitude
3	Indicated airspeed or calibrated airspeed
4	Heading
5	Normal acceleration
6	Pitch attitude
7	Roll attitude

8	Manual radio transmission keying
9	Propulsive thrust/power on each engine and flight crew compartment thrust/power lever position if applicable
10	Trailing edge flap or flight crew compartment control selection
11	Leading edge flap or flight crew compartment control selection
12	Thrust reverse status
13	Ground spoiler position and/or speed brake selection
14	Total or outside air temperature
15	Autopilot, autothrottle and AFCS mode and engagement status
16	Longitudinal acceleration (body axis)
17	Lateral acceleration

Table 1b: FDR — Aeroplanes with an MCTOM 5 700 kg or below

No	Parameter
1	Time or relative time count
2	Pressure altitude
3	Indicated airspeed or calibrated airspeed
4	Heading
5	Normal acceleration
6	Pitch attitude
7	Roll attitude
8	Manual radio transmission keying
9	Propulsive thrust/power on each engine and flight crew compartment thrust/power lever position if applicable
10	Trailing edge flap or flight crew compartment control selection
11	Leading edge flap or flight crew compartment control selection
12	Thrust reverse status
13	Ground spoiler position and/or speed brake selection
14	Total or outside air temperature
15	Autopilot/autothrottle engagement status
16	Longitudinal acceleration (body axis)
17	Angle of attack (if a suitable sensor is available)



Table 2: FDR — Additional parameters for aeroplanes with an MCTOM of more than 27 000 kg

No	Parameter
18	Primary flight controls — control surface position and/or pilot input (pitch, roll, yaw)
19	Pitch trim position
20	Radio altitude
21	Vertical beam deviation (ILS glide path or MLS elevation)
22	Horizontal beam deviation (ILS localiser or MLS azimuth)
23	Marker beacon passage
24	Warnings
25	Reserved (navigation receiver frequency selection is recommended)
26	Reserved (DME distance is recommended)
27	Landing gear squat switch status or air/ground status
28	Ground proximity warning system
29	Angle of attack
30	Low pressure warning (hydraulic and pneumatic power)
31	Groundspeed
32	Landing gear or gear selector position

Table 3: FDR — Aeroplanes equipped with electronic display systems

No	Parameter
33	Selected barometric setting (each pilot station)
34	Selected altitude
35	Selected speed
36	Selected Mach
37	Selected vertical speed
38	Selected heading
39	Selected flight path
40	Selected decision height
41	EFIS display format
42	Multi-function/engine/alerts display format

**AMC3 CAT.IDE.A.190 Flight data recorder**

PERFORMANCE SPECIFICATIONS FOR THE PARAMETERS TO BE RECORDED FOR AEROPLANES FIRST ISSUED WITH AN INDIVIDUAL COFA ON OR AFTER 1 APRIL 1998 AND BEFORE 1 JANUARY 2016

Parameter	Range	Sampling interval in seconds	Accuracy limits (sensor input compared to FDR readout)	Recommended resolution in readout	Remarks
Time	24 hours	4	± 0.125 % per hour	1 second	(a) UTC time preferred where available.
Relative time count	0 to 4 095	4	± 0.125 % per hour		(b) Counter increments every 4 seconds of custom operation
Pressure altitude	-1 000 ft to maximum certificated altitude of aircraft	1	±100 ft to ±700 ft Refer to Table II-A.3 of EUROCAE Document ED-112	5 ft	Should be obtained from air data computer when installed.
Indicated airspeed or calibrated airspeed	50 kt or minimum value installed pitotstatic system to Max VSO Max VSO to	1	±5 % ±3 %	1 kt (0.5 kt recommended)	Should be obtained from air data computer when installed. VSO: stalling speed or minimum steady flight speed in the landing configuration V <sub>D</sub> design
Heading	360 degrees	1	±2 degrees	0.5 degrees	

	Normal acceleration	-3 g to +6 g	0.125	1 % of maximum range excluding a datum error of 5 %	0.004 g	The recording resolution may be rounded from 0.004 g to 0.01 g provided that one sample is recorded at full resolution at least every 4 seconds.
	Pitch attitude	±75 degrees	0.25	±2 degrees	0.5 degrees	
	Roll attitude	±180 degrees	0.5	±2 degrees	0.5 degrees	
	Manual radio transmission keying	Discrete	1	-	-	Preferably each crew member but one discrete acceptable for all transmissions provided that the replay of a recording made by any required recorder can be synchronised in time with any other required recording to within 1
	Propulsive thrust/power on each engine	Full range	Each engine each second	±2 %	0.2 % of full range	Sufficient parameters, e.g. EPR/N, or Torque/NP as appropriate to the particular engine must be recorded to determine power in both normal and reverse thrust. A margin for possible overspeed should be provided.

	Flight crew compartment thrust/power lever position	Full range	Each lever each second	$\pm 2\%$ or sufficient to determine any gated position	2 % of full range	Parameter 9b must be recorded for aeroplanes with non-mechanically linked cockpit-engine controls, otherwise recommended.
	Trailing edge flap or flight crew compartment control selection	Full range or each disc rete position	2	$\pm 3^\circ$ or as pilot's indicator and sufficient to determine each discrete position	0.5 % of full range	Flap position and cockpit control may be sampled at 4-second intervals so as to give a data point each 2 seconds.
	Leading edge flap or flight crew compartment control selection	Full range or each disc rete position	1	$\pm 3^\circ$ or as pilot's indicator and sufficient to determine each discrete position	0.5 % of full range	Left and right sides, or flap position and cockpit control may be sampled at 2-second intervals so as to give a data point each second.
	Thrust reverser status	Turbo-jet: stowed, in transit and reverse Turbo-prop: reverse	Each reverser each second	-	-	Turbo-jet: 2 disc retes enable the 3 states to be determined Turbo-prop: 1 discrete
	Ground spoiler and/or speed brake selection	Full range or each disc rete position	0.5	$\pm 2^\circ$ unless higher accuracy uniquely required	0.2 % of full range	Sufficient to determine use of the cockpit selector and the activation and positions of the surfaces

	Outside air temperatures or total air temperature	-50°C to +90°C or available sensor range	2	±2°C	0.3°C	
	Autopilot/Autothrottle/AFCS mode and engagement status	A suitable combination of discrettes	1	-	-	Discrettes should show which systems are engaged and which primary modes are controlling the flight path and speed of the aircraft.
	Longitudinal acceleration (Body axis)	± 1 g	0.25	±1.5 % of maximum range excluding a datum error of ±5 %	0.004 g	The recording resolution may be rounded from 0.004 g to 0.01 g provided that one sample is recorded at full resolution at least every 4 seconds.
	Lateral acceleration	±1 g	0.25	±1.5 % of maximum range excluding a datum error of ±5 %	0.004 g	The recording resolution may be rounded from 0.004 g to 0.01 g provided that one sample is recorded at full resolution at least every 4 seconds.
	Primary flight controls, control surface positions and/or* pilot input	Full range	1	±2° unless higher accuracy uniquely required	0.2 % of full range	
	Pitch axis		0.25			*For aeroplanes that can demonstrate the capability of deriving either the control input or control movement (one from the other) for all

	Roll axis		0.25			<p>modes of operation and flight regimes, the 'or' applies. For aeroplanes with non-mechanical control systems, the 'and' applies.</p>
	Yaw axis		0.5			<p>Where the input controls for each pilot can be operated independently, both inputs will need to be recorded. For multiple or split surfaces, a suitable combination of inputs is acceptable in lieu of recording each surface separately.</p>
	Pitch trim position	Full range	1	±3 % unless higher accuracy uniquely required	0.3 % of full range	<p>Where dual surfaces are provided it is permissible to record each surface alternately.</p>
	Radio altitude	-20 ft to +2 500 ft	1	As installed ±2 ft or ±3 % whichever is greater below 500 ft and ±5 % above 500 ft recommended.	1 ft below 500 ft, 1 ft +0.5 % of full range above 500 ft	<p>For auto-land/category III operations, each radio altimeter should be recorded, but arranged so that at least one is recorded each second.</p>

	Vertical beam deviation		1	As installed ±3 % recommended	0.3 % range of full range	Data from both the ILS and MLS systems need not to be recorded at the same time. The approach aid in use should be recorded. For auto-land/ category III operations, each radio altimeter should be recorded, but arranged so that at least one is recorded each second.
	ILS glide path	±0.22 DDM or available sensor range				
	MLS elevation	0.9° to 30°				
	Horizontal beam deviation	Signal range	1	As installed ±3 % recommended	0.3 % range of full range	See parameter 21 remarks.
	ILS Localiser	±0.22 DDM or available sensor range				
	MLS azimuth	±62°				
	Marker beacon passage	Discrete	1	—	—	A single discrete is acceptable for all markers.



	Warnings	Discretets	1	–	–	A discrete must be recorded for the master warning. Each 'red' warning (including lavatory smoke) should be recorded when the warning condition cannot be determined from other parameters or from the cockpit voice recorder.
	Reserved	–	–	–	–	
	Reserved	–	–	–	–	
	Landing gear squat switch status	Discrete(s)	1 (0.25 recommended for main gears)	–	–	Discretets should be recorded for the nose and main landing gears.
	Ground proximity warning system(GPWS)	Discrete	1	–	–	A suitable combination of discretets unless recorder capacity is limited in which case a single discrete for all modes is acceptable.

	Angle of attack	As installed	0.5	As installed	0.3 % range of full range	If left and right sensors are available, each may be recorded at 1-second intervals so as to give a data point each half second.
	Low pressure warning	Discrete(s) or available sensor range	2	-	0.5 % range of full range	Each essential system to be recorded.
	Hydraulic power					
	Pneumatic power					
	Groundspeed	As installed	1	Data should be obtained from the most accurate system	1 kt	
	Landing gear or gear selector position	Discrete(s)	4	-	-	A suitable combination of discrete should be recorded
	Selected barometric setting (each pilot station)	As installed	64	As installed	1 mb	Where practicable, a sampling interval of 4 seconds is recommended
	Pilot					
	Co-pilot					
	Selected altitude	As installed	1	As installed	100 ft	Where capacity is limited, a sampling interval of 64 seconds is permissible.
	Manual					
	Automatic					
	Selected speed	As installed	1	As installed	1 kt	Where capacity is limited, a

	Manual					sampling interval of 64 seconds is permissible.
	Automatic					
	Selected Mach	As installed	1	As installed	0.01	Where capacity is limited, a sampling interval of 64 seconds is permissible.
	Manual					
	Automatic					
	Selected vertical speed	As installed	1	As installed	100 ft/min	Where capacity is limited, a sampling interval of 64 seconds is permissible.
	Manual					
	Automatic					
	Selected heading	360 degrees	1	As installed	1 degree	Where capacity is limited ,a sampling interval of 64 seconds is permissible.
	Selected flight path		1	As installed		Where capacity is limited, a sampling interval of 64 seconds is permissible.
	Course/DSTRK	360 degrees				
	Path Angle	As installed				
	Selected decision height	0-500 ft	64	As installed	1 ft	
	EFIS display format	Discrete(s)	4	–	–	Discretes should show the

	Pilot					display system status e.g. off, normal, fail, composite, sector, plan, rose, nav aids, wxr, range, copy.
	Co-pilot					
	Multifunction/Engine/Alerts display format	Discrete(s)	4	–	–	Discretes should show the display system status e.g. off, normal, fail, and the identity of display pages for emergency procedures and checklists. Information in checklists and procedures need not be recorded.

**AMC4 CAT.IDE.A.190 Flight data recorder**

LIST OF PARAMETERS TO BE RECORDED FOR AEROPLANES FIRST ISSUED WITH AN INDIVIDUAL COFA ON OR AFTER 1 JUNE 1990 UP TO AND INCLUDING 31 MARCH 1998

- (a) The FDR should, with reference to a timescale, record:
- (1) the parameters listed in Table 1 below; and
  - (2) the additional parameters listed in Table 2 below for those aeroplanes with an MCTOM exceeding 27 000 kg.
- (b) When determined by the Libyan CAA, the FDR of aeroplanes having an MCTOM of 27 000 kg or below does not need to record parameters 14 and 15b of Table 1 below if any of the following conditions are met:
- (1) the sensor is not readily available;
  - (2) sufficient capacity is not available in the flight recorder system; or
  - (3) a change is required in the equipment that generates the data.
- (c) When determined by the Libyan CAA, the FDR of aeroplanes having an MCTOM exceeding 27 000 kg does not need to record parameter 15b of Table 1 below, and parameters 23, 24, 25, 26, 27, 28, 29, 30 and 31 of Table 2 below, if any of the following conditions are met:
- (1) the sensor is not readily available;
  - (2) sufficient capacity is not available in the FDR system;
  - (3) a change is required in the equipment that generates the data; or
  - (4) for navigational data (NAV frequency selection, DME distance, latitude, longitude, ground speed and drift), the signals are not available in digital form.
- (d) When determined by the Libyan CAA, the FDR does not need to record individual parameters that can be derived by calculation from the other recorded parameters.
- (e) The parameters to be recorded should meet, as far as practicable, the performance e specifications (range, sampling intervals, accuracy limits, and resolution in read- out) defined in Table 1 of AMC5 CAT.IDE.A.190.

Table 1: Flight data recorder — Aeroplanes with an MCTOM of more than 5 700 kg

No	Parameter
1	Time or relative time count
2	Pressure altitude
3	Indicated airspeed or calibrated airspeed
4	Heading
5	Normal acceleration
6	Pitch attitude
7	Roll attitude
8	Manual radio transmission keying unless an alternate means to synchronise FDR and CVR recordings is provided
9	Power on each engine
10	Trailing edge flap or flight crew compartment control selection

11	Leading edge flap or flight crew compartment control selection
12	Thrust reverse position (for turbojet aeroplanes only)
13	Ground spoiler position and/or speed brake selection
14	Outside air temperature or total air temperature
15a 15b	Autopilot engagement status Autopilot operating modes, autothrottle and AFCS systems engagement status and operating modes.

Table 2: Flight data recorder — Additional parameters for aeroplanes with an MCTOM of more than 27 000 kg

No	Parameter
16	Longitudinal acceleration
17	Lateral acceleration
18	Primary flight controls — control surface position and/or pilot input (pitch, roll and yaw)
19	Pitch trim position
20	Radio altitude
21	Glide path deviation
22	Localiser deviation
23	Marker beacon passage
24	Master warning
25	NAV 1 and NAV 2 frequency selection
26	DME 1 and DME 2 distance
27	Landing gear squat switch status
28	Ground proximity warning system(GPWS)
29	Angle of attack
30	Hydraulics, each system(low pressure)
31	Navigation data

32	Landing gear or gear selector position
----	--

**AMC5 CAT.IDE.A.190 Flight data recorder**

PERFORMANCE SPECIFICATIONS FOR THE PARAMETERS TO BE RECORDED FOR AEROPLANES FIRST ISSUED WITH AN INDIVIDUAL COFA UP TO AND INCLUDING 31 MARCH 1998

Table 1: Flight data recorder

No	Parameter	Range	Sampling interval in seconds	Accuracy limits (sensor input compared to FDR readout)	Recommended resolution in readout	Remarks
1	Time or relative time count	24 hours	4	±0.125 % per hour	1 second	Coordinated universal time (UTC) preferred where available, otherwise elapsed time
2	Pressure altitude	-1 000 ft to maximum certificated altitude of aircraft +5 000 ft	1	±100 ft to ±700 ft	5 ft	For altitude record error see EASA ETSO-C124a
3	Indicated airspeed or calibrated airspeed	50 kt to max VSO Max VSO to 1.2 Vd	1	±5 % ±3 %	1 kt	VSO stalling speed or minimum steady flight speed in the landing configuration VD design diving speed
4	Heading	360 degrees	1	±2 degrees	0.5 degrees	
5	Normal acceleration	-3 g to +6 g	0.125 ±	±1 % of maximum range excluding a datum error of ±5 %	0.004 g	



No	Parameter	Range	Sampling interval in seconds	Accuracy limits (sensor input compared to FDR readout)	Recommended resolution in readout	Remarks
6	Pitch attitude	±75 degrees	1	±2 degrees	0.5 degrees	
7	Roll attitude	±180 degrees	1	±2 degrees	0.5 degrees	
8	Manual radio transmission keying	Discrete	1	-	-	On-off (one discrete). An FDR/CVR time synchronisation signal complying with 4.2.1 of EUROCAE ED-55 is considered to be an acceptable alternative means of compliance.
9	Power on each engine	Full range	Each engine each second	±2 %	0.2 % of full range	Sufficient parameters e.g. EPR/N, or Torque/NP as appropriate to the particular engine should be recorded to determine power.
10	Trailing edge flap or flight crew compartment control selection	Full range or each discrete position	2	±5 % or as pilot's indicator	0.5 % of full range	
11	Leading edge flap or flight crew compartment control selection	Full range or each discrete position	2	-	0.5 % of full range	

No	Parameter	Range	Sampling interval in seconds	Accuracy limits (sensor input compared to FDR readout)	Recommended resolution in readout	Remarks
12	Thrust reverser position	Stowed, in transit and reverse	Each reverser each second	±2 % unless higher accuracy uniquely required	-	
13	Ground spoiler and/or speed brake selection	Full range or each discrete position	1	±2 degrees	0.2 % of full range	
14	Outside air temperatures or total air	Sensor range	2	-	0.3°C	
15a	Autopilot engagement status					
15b	Autopilot operating modes, auto-throttle and AFCS systems engagement status and	A suitable combination of discretised	1		-	
16	Longitudinal acceleration	± 1 g	0.25	±1.5 % of maximum range excluding a datum error of ±5 %	0.004 g	
17	Lateral acceleration	±1 g	0.25	±1.5 % of maximum range excluding a datum error of ±5 %	0.004 g	

18	Primary flight controls, control surface positions and/or pilot input (pitch, roll, yaw)	Full range	1	±2 degrees unless higher accuracy uniquely required	0.2 % of full range	For aeroplanes with conventional control systems, 'or' applies. For aeroplanes with non-mechanical control systems, 'and' applies. For aeroplanes with split surfaces, a suitable combination of inputs is acceptable in lieu of recording each surface
19	Pitch trim position	Full range	1	±3 % unless higher accuracy uniquely required	0.3 % of full range	
20	Radio altitude	-20 ft to +2 500 ft	1	±2 ft or ±3 % whichever is greater below 500 ft and ±5 % above 500 ft	1 ft below 500 ft, 1 ft +5 % of full range above 500 ft	As installed. Accuracy limits are recommended
21	Glide path deviation	Signal range	1	±3 %	0.3 % of full range	As installed. Accuracy limits are recommended
22	Localiser deviation	Signal range	1	±3 %	0.3 % of full range	As installed. Accuracy limits are recommended.
23	Marker beacon passage	Discrete	1	–	–	A single discrete is acceptable for all markers.
24	Master warning	Discrete	1	–	–	
25	NAV 1 and 2 frequency selection	Full range	4	As installed	–	
26	DME 1 and 2 distance	0-200 NM	4	As installed	–	Recording of latitude and longitude from INS or other navigation system is a preferred alternative.

27	Landing gear Squat switch status	Discrete	1	–	–	
28	Ground proximity warning system (GPWS)	Discrete	1	–	–	
29	Angle of attack	Full range	0.5	As installed	0.3 % of full range	
30	Hydraulics	Discrete(s)	2	–	–	
31	Navigation data	As installed	1	As installed	–	
32	Landing gear or gear selector position	Discrete	4	As installed	–	

\* The number in the left hand column reflects the serial number depicted in EUROCAE Document ED -112.

**AMC6 CAT.IDE.A.190 Flight data recorder****LIST OF PARAMETERS TO BE RECORDED FOR AEROPLANES FIRST ISSUED WITH AN INDIVIDUAL COFA BEFORE 1 JUNE 1990**

- (a) The FDR should, with reference to a timescale, record:
- (1) the parameters listed in Table 1 below;
  - (2) the additional parameters 6 to 15b of Table 2 below, for aeroplanes with an MCTOM exceeding 5 700 kg but not exceeding 27 000 kg and first issued with an individual CofA on or after 1 January 1989, when the following conditions are met:
    - (i) sufficient capacity is available on a flight recorder system;
    - (ii) the sensor is readily available; and
    - (iii) a change is not required in the equipment that generates the data;
  - (3) the additional parameters from 6 to 15b of Table 2 below, for aeroplanes with a maximum certificated take-off mass exceeding 27 000 kg that are of a type first type certified after 30 September 1969; and
  - (4) the additional parameters listed in Table 2 below for aeroplanes with an MCTOM exceeding 27 000 kg and first issued with an individual CofA on or after 1 January 1987, when the following conditions are met:
    - (i) sufficient capacity is available on a flight recorder system;
    - (ii) the sensor is readily available; and
    - (iii) a change is not required in the equipment that generates the data.
- (b) When determined by the Libyan CAA, the FDR of aeroplanes with an MCTOM exceeding 27 000 kg that are of a type first type certified after 30 September 1969 does not need to record the parameters 13, 14 and 15b in Table 2 below, when any of the following conditions are met:
- (1) sufficient capacity is not available on a flight recorder system;
  - (2) the sensor is not readily available; and
  - (3) a change is required in the equipment that generates the data.
- (c) The parameters to be recorded should meet, as far as practicable, the performance specifications (range, sampling intervals, accuracy limits, and resolution in read-out) defined in Table 1 of AMC5 CAT.IDE.A.190).
- (d) When so determined by the Libyan CAA, the FDR does not need to record individual parameters that can be derived by calculation from the other recorded parameters.

Table 1: Flight data recorder — aeroplanes with an MCTOM exceeding 5 700 kg

No	Parameter
1	Time or relative time count
2	Pressure altitude
3	Indicated airspeed or calibrated airspeed
4	Heading
5	Normal acceleration

\* The number in the left hand column reflects the serial number depicted in EUROCAE Document ED-112.

Table 2: Additional parameters for aeroplanes under conditions of AMC6 CAT.IDE.A.190, 1 &amp; 2

No	Parameter
6	Pitch attitude
7	Roll attitude
8	Manual radio transmission keying unless an alternate means to synchronise the FDR and CVR recordings is provided
9	Power on each engine
10	Trailing edge flap or flight crew compartment control selection
11	Leading edge flap or flight crew compartment control selection
12	Thrust reverse position (for turbojet aeroplanes only)
13	Ground spoiler position and/or speed brake selection
14	Outside air temperature (OAT) or total air temperature
15a 15b	Autopilot engagement status Autopilot operating modes, autothrottle and AFCS, systems engagement status and operating modes.
16	Longitudinal acceleration
17	Lateral acceleration
18	Primary flight controls — control surface position and/or pilot input (pitch, roll and yaw)
19	Pitch trim position
20	Radio altitude
21	Glide path deviation
22	Localiser deviation
23	Marker beacon passage
24	Master warning
25	NAV 1 and NAV 2 frequency selection
26	DME 1 and DME 2 distance
27	Landing gear squat switch status
28	Ground proximity warning system(GPWS)
29	Angle of attack
30	Hydraulics, each system(low pressure)
31	Navigation data (latitude, longitude, ground speed and drift angle)
32	Landing gear or gear selector position

\* The number in the left hand column reflects the serial number depicted in EUROCAE Document ED-112.

**GM1 CAT.IDE.A.190 Flight data recorder**

## GENERAL

- (a) The alleviation of AMC2 CAT.IDE.A.190(d) affects a small number of aeroplanes first issued with an individual CofA on or after 1 April 1998 that were either constructed prior to this date or to a specification in force just prior to this date. These aeroplanes may not comply fully with AMC2 CAT.IDE.A.190(b), but are able to comply with AMC4 CAT.IDE.A.190. In addition, this alleviation applies only if compliance with AMC2 CAT.IDE.A.190(b) would imply significant modifications to the aeroplane with a severe re- certification effort.
- (b) Flight data recorder systems installed on board aeroplanes first issued with an individual CofA up to and including 31 March 1998, and for which the recorded parameters do not comply with the performance specifications of Table 1 of AMC5 CAT.IDE.A.190 (i.e. range, sampling intervals, accuracy limits and recommended resolution readout) may be acceptable to the Libyan CAA.
- (c) The alleviations of AMC4 CAT.IDE.A.190(b) and (c), and AMC6 CAT.IDE.A.190(b), are acceptable only if adding the recording of missing parameters to the existing flight data recorder system would require a major upgrade of the system itself. Account is taken of the following:
  - (1) The extent of the modification required;
  - (2) The downtime period; and
  - (3) Equipment software development.
- (d) For the purpose of AMC4 CAT.IDE.A.190(b) and (c), and AMC6 CAT.IDE.A.190(a) and (b), 'capacity available' refers to the space on both the flight data acquisition unit and the flight data recorder not allocated for recording the required parameters, or the parameters recorded for the purpose of the Flight Data Monitoring programme, as determined by the Libyan CAA.
- (e) For the purpose of AMC4 CAT.IDE.A.190(b) and (c), and AMC6 CAT.IDE.A.190(a) and (b), a sensor is considered 'readily available' when it is already available or can be easily incorporated.
- (f) For aeroplanes first issued with an individual CofA up to and including 31 March 1998, the recording of the following additional parameters may be considered:
  - (1) Remaining parameters in Table 2 of AMC4 CAT.IDE.A.190 or Table 2 of AMC6 CAT.IDE.A.190 as applicable;
  - (2) Any dedicated parameter relating to novel or unique design or operational characteristics of the aeroplane;
  - (3) operational information from electronic display systems, such as EFIS, ECAM or EICAS, with the following order of priority:
    - (i) parameters selected by the flight crew relating to the desired flight path,
    - (ii) e.g. barometric pressure setting, selected altitude, selected airspeed, decision height, and autoflight system engagement and mode indications if not recorded from another source;
    - (iii) display system selection/status, e.g. SECTOR, PLAN, ROSE, NAV, WXR, COMPOSITE, COPY, etc.;
    - (iv) warning and alerts;
    - (v) the identity of displayed pages from emergency procedures and checklists.
  - (4) retardation information including brake application for use in the investigation of landing overruns or rejected take offs; and
  - (5) additional engine parameters (EPR, N1, EGT, fuel flow, etc.).

**AMC1 CAT.IDE.A.195 Data link recording**

## GENERAL

- (a) As a means of compliance with CAT.IDE.A.195(a), the recorder on which the data link messages is recorded may be:
- (1) the CVR;
  - (2) the FDR;
  - (3) a combination recorder when CAT.IDE.A.200 is applicable; or
  - (4) a dedicated flight recorder. In that case, the operational performance requirements for this recorder should be those laid down in EUROCAE Document ED- 112 (Minimum Operational Performance Specification for Crash Protected Airborne Recorder Systems) dated March 2003, including amendments No 1 and No 2, or any later equivalent standard produced by EUROCAE.
- (b) As a means of compliance with CAT.IDE.A.195(a)(2), the operator should enable correlation by providing information that allows an accident investigator to understand what data was provided to the aeroplane and, when the provider identification is contained in the message, by which provider.
- (c) The timing information associated with the data link communications messages required to be recorded by CAT.IDE.A.195(a)(3) should be capable of being determined from the airborne-based recordings. This timing information should include at least the following:
- (1) the time each message was generated;
  - (2) the time any message was available to be displayed by the crew;
  - (3) the time each message was actually displayed or recalled from a queue; and
  - (4) the time of each status change.
- (d) The message priority should be recorded when it is defined by the protocol of the data link communication message being recorded.
- (e) The expression 'taking into account the system architecture', in CAT.IDE.A.195(a)(3), means that the recording of the specified information may be omitted if the existing source systems involved would require a major upgrade. The following should be considered:
- (1) the extent of the modification required;
  - (2) the down-time period; and
  - (3) equipment software development.
- The intention is that new designs of source systems should include this functionality and support the full recording of the required information.
- (f) Data link communications messages that support the applications in Table 1 below should be recorded.
- (g) Further details on the recording requirements can be found in the recording requirement matrix in Appendix D.2 of EUROCAE Document ED- 93 (Minimum Aviation System Performance Specification for CNS/ATM Recorder Systems, dated November 1998).



Table 1: Applications

Item No	Application Type	Application Description	Required Recording Content
1	Data link initiation	This includes any application used to log on to, or initiate, a data link service. In future air navigation system (FANS)-1/A and air traffic navigation (ATN), these are ATS facilities notification (AFN) and context management (CM) respectively.	C
2	Controller/pilot communication	This includes any application used to exchange requests, clearances, instructions and reports between the flight crew and air traffic controllers. In FANS-1/A and ATN, this includes the controller pilot data link communications (CPDLC) application. It also includes applications used for the exchange of oceanic (OCL) and departure clearances (DCL) as well as data link delivery of taxi clearances.	C
3	Addressed surveillance	This includes any surveillance application in which the ground sets up contracts for delivery of surveillance data. In FANS- 1/A and ATN, this includes the automatic dependent surveillance-contract (ADS-C) application.	C, F2
4	Flight information	This includes any application used for delivery of flight information data to specific aeroplanes. This includes for example, digital automatic terminal information service (D-ATIS), data link operational terminal information service (D-OTIS), digital weather information services (D-METAR or TWIP), data link flight information service (D-FIS), and Notice to Airmen (electronic NOTAM) delivery.	C
5	Aircraft broadcast surveillance	This includes elementary and enhanced surveillance systems, as well as automatic dependent surveillance-broadcast (ADS-B) output data.	M*, F2
6	Aeronautical operational control (AOC) data	This includes any application transmitting or receiving data used for AOC purposes (in accordance with the ICAO definition of AOC). Such systems may also process AAC messages, but there is no requirement to record AAC messages.	M*
7	Graphics	This includes any application receiving graphical data to be used for operational purposes (i.e. excluding applications that are receiving such things as updates to manuals).	M* F1

**GM1 CAT.IDE.A.195 Data link recording**

## DEFINITIONS AND ACRONYMS

- (a) The letters and expressions in Table 1 of AMC1 CAT.IDE.A.195 have the following meaning:

C: complete contents recorded

M: information that enables correlation with any associated records stored separately from the aeroplane.

\*: Applications that are to be recorded only as far as is practicable, given the architecture of the system.

F1: graphic s applications may be considered as AOC messages when they are part of a data link communications application service run on an individual basis by the operator itself in the framework of the operational control.

F2: where parametric data sent by the aeroplane, such as Mode S, is reported within the message, it should be recorded unless data from the same source is recorded on the FDR.

- (b) The definitions of the applications type in Table 1 of AMC1 CAT.IDE.A.195 are described in Table 1 below.

Table 1: Definitions of applications type

Item No	Application Type	Messages	Comments
1	CM		CM is an ATN service
2	AFN		AFN is a FANS 1/A service
3	CPDLC		All implemented up and downlink messages to be recorded
4	ADS- C	ADS- C reports	All contract requests and reports recorded
		Position reports	Only used within FANS 1/A. Only used in oceanic and remote areas.
5	ADS- B	Surveillance data	Information that enables correlation with any associated records stored separately from the aeroplane.
6	D-FIS		D-FIS is an ATN service. All implemented up and downlink messages to be recorded
7	TWIP	TWIP messages	Terminal weather information for pilots
8	D- ATIS	ATIS messages	Refer to EUROCAE Document ED- 89A dated December 2003. Data Link Application System Document (DLASD) for the 'ATIS' Data Link Service

9	OCL	OCL messages	Refer to EUROCAE Document ED-106A dated March 2004. Data Link Application System Document (DLASD) for 'Oceanic Clearance' Data Link Service
10	DCL	DCL messages	Refer to EUROCAE Document ED-85A dated December 2003. Data Link Application System Document (DLASD) for 'Departure Clearance' Data Link Service
11	Graphics	Weather maps & other graphics	Graphics exchanged in the framework of procedures within the operational control, as specified in Part-ORO. Information that enables correlation with any associated records stored separately from the aeroplane.
12	AOC	Aeronautical operational control messages	Messages exchanged in the framework of procedures within the operational control, as specified in Part-ORO. Information that enables correlation with any associated records stored separately from the aeroplane. Definition in EUROCAE Document ED-112, dated March 2003.
13	Surveillance	Downlinked aircraft parameters (DAP)	As defined in ICAO Annex 10 Volume IV (Surveillance systems and ACAS).

<i>AAC</i>	<i>aeronautical administrative communications</i>
<i>ADS-B</i>	<i>automatic dependent surveillance — broadcast</i>
<i>ADS-C</i>	<i>automatic dependent surveillance — contract</i>
<i>AFN</i>	<i>aircraft flight notification</i>
<i>AOC</i>	<i>aeronautical operational control</i>
<i>ATIS</i>	<i>automatic terminal information service</i>
<i>ATSC</i>	<i>air traffic service communication</i>
<i>CAP</i>	<i>controller access parameters</i>
<i>CPDLC</i>	<i>controller pilot data link communications</i>
<i>CM</i>	<i>configuration/context management</i>
<i>D- ATIS</i>	<i>digital ATIS</i>
<i>D- FIS</i>	<i>data link flight information service</i>
<i>D-METAR</i>	<i>data link meteorological airport report</i>
<i>DCL</i>	<i>departure clearance</i>
<i>FANS</i>	<i>Future Air Navigation System</i>
<i>FLIPCY</i>	<i>flight plan consistency</i>
<i>OCL</i>	<i>oceanic clearance</i>
<i>SAP</i>	<i>system access parameters</i>
<i>TWIP</i>	<i>terminal weather information for pilots</i>

## **GM1 CAT.IDE.A.195(a) Data link recording**

### **APPLICABILITY OF THE DATA LINK RECORDING REQUIREMENT**

- (a) If it is certain that the aeroplane cannot use data link communication messages for ATS communications corresponding to any application designated by CAT.IDE.A.195(a)(1), then the data link recording requirement does not apply
- (b) Examples where the aeroplane cannot use data link communication messages for ATS communications include but are not limited to the cases where:
  - (1) the aeroplane data link communication capability is disabled permanently and in a way that it cannot be enabled again during the flight;
  - (2) data link communications are not used to support air traffic service (ATS) in the area of operation of the aeroplane; and
  - (3) the aeroplane's data link communication equipment cannot communicate with the equipment used by ATS in the area of operation of the aeroplane.

### **AMC1 CAT.IDE.A.200 Combination recorder**

#### GENERAL

When two flight data and cockpit voice combination recorders are installed, one should be located near the flight crew compartment, in order to minimise the risk of data loss due to a failure of the wiring that gathers data to the recorder. The other should be located at the rear section of the aeroplane, in order to minimise the risk of data loss due to recorder damage in the case of a crash.

### **GM1 CAT.IDE.A.200 Combination recorder**

#### GENERAL

- (a) A flight data and cockpit voice combination recorder is a flight recorder that records:
  - (1) all voice communications and aural environment required by CAT.IDE.A.185 regarding CVRs; and
  - (2) all parameters required by CAT.IDE.A.190 regarding FDRs, with the same specifications required by those paragraphs.
- (b) In addition, a flight data and cockpit voice combination recorder may record data link communication messages and related information required by CAT.IDE.A.195.

### **AMC1 CAT.IDE.A.205 Seats, seat safety belts, restraint systems and child restraint devices**

#### CHILD RESTRAINT DEVICES (CRDs)

- (a) A CRD is considered to be acceptable if:
  - (1) it is a 'supplementary loop belt' manufactured with the same techniques and the same materials as the approved safety belts; or
  - (2) it complies with (b).
- (b) Provided the CRD can be installed properly on the respective aircraft seat, the following CRDs are considered acceptable:
  - (1) CRDs approved for use in aircraft by the competent authority on the basis of a technical standard and marked accordingly;
  - (2) CRDs approved for use in motor vehicles according to the UN standard ECE R 44, -03 or later series of amendments;
  - (3) CRDs approved for use in motor vehicles and aircraft according to Canadian CMVSS 213/213.1;
- (4) CRDs approved for use in motor vehicles and aircraft according to US FMVSS No 213 and manufactured to these standards on or after 26 February 1985. US approved CRDs manufactured after this date must bear the following labels in red letters:
  - (i) 'THIS CHILD RESTRAINT SYSTEM CONFORMS TO ALL APPLICABLE FEDERAL MOTOR VEHICLE SAFETY STANDARDS'; and

- (ii) 'THIS RESTRAINT IS CERTIFIED FOR USE IN MOTOR VEHICLES AND AIRCRAFT';
  - (5) CRDs qualified for use in aircraft according to the German 'Qualification Procedure for Child Restraint Systems for Use in Aircraft' (TÜV Doc.: TÜV/958-01/2001); and
  - (6) devices approved for use in cars, manufactured and tested to standards equivalent to those listed above. The device should be marked with an associated qualification sign, which shows the name of the qualification organisation and a specific identification number, related to the associated qualification project. The qualifying organisation should be a competent and independent organisation that is acceptable to the competent authority.
- (c) Location
- (1) Forward-facing CRDs may be installed on both forward-and rearward-facing passenger seats, but only when fitted in the same direction as the passenger seat on which they are positioned. Rearward-facing CRDs should only be installed on forward-facing passenger seats. A CRD should not be installed within the radius of action of an airbag unless it is obvious that the airbag is de-activated or it can be demonstrated that there is no negative impact from the airbag.
  - (2) An infant in a CRD should be located as near to a floor level exit as feasible.
  - (3) An infant in a CRD should not hinder evacuation for any passenger.
  - (4) An infant in a CRD should neither be located in the row (where rows are existing) leading to an emergency exit nor located in a row immediately forward or aft of an emergency exit. A window passenger seat is the preferred location. An aisle passenger seat or a cross aisle passenger seat that forms part of the evacuation route to exits is not recommended. Other locations may be acceptable provided the access of neighbour passengers to the nearest aisle is not obstructed by the CRD.
  - (5) In general, only one CRD per row segment is recommended. More than one CRD per row segment is allowed if the infants are from the same family or travelling group provided the infants are accompanied by a responsible adult sitting next to them.
  - (6) A row segment is the fraction of a row separated by two aisles or by one aisle and the aeroplane fuselage.
- (d) Installation
- (1) CRDs should only be installed on a suitable aeroplane seat with the type of connecting device they are approved or qualified for. For instance, CRDs to be connected by a three-point harness only (most rearward-facing baby CRDs currently available) should not be attached to an aeroplane seat with a lap belt only; a CRD designed to be attached to a vehicle seat only by means of rigid bar lower anchorages (ISO-FIX or US equivalent), should only be used on aeroplane seats that are equipped with such connecting devices and should not be attached by the aeroplane seat lap belt. The method of connecting should be the one shown in the manufacturer's instructions provided with each CRD.
  - (2) All safety and installation instructions should be followed carefully by the responsible adult accompanying the infant. Cabin crew should prohibit the use of any inadequately installed CRD or not qualified seat.
  - (3) If a forward- facing CRD with a rigid backrest is to be fastened by a lap belt, the restraint device should be fastened when the backrest of the passenger seat on which it rests is in a reclined position. Thereafter, the backrest is to be positioned upright. This procedure ensures better tightening of the CRD on the aircraft seat if the aircraft seat is reclinable.

- (4) The buckle of the adult safety belt must be easily accessible for both opening and closing, and must be in line with the seat belt halves (not canted) after tightening.
  - (5) Forward-facing restraint devices with an integral harness must not be installed such that the adult safety belt is secured over the infant.
- (e) Operation
- (1) Each CRD should remain secured to a passenger seat during all phases of flight unless it is properly stowed when not in use.
  - (2) Where a CRD is adjustable in recline, it must be in an upright position for all occasions when passenger restraint devices are required.

### **AMC2 CAT.IDE.A.205 Seats, seat safety belts, restraint systems and child restraint devices**

#### UPPER TORSO RESTRAINT SYSTEM

An upper torso restraint system having two shoulder straps and additional straps is deemed to be compliant with the requirement for restraint systems with two shoulder straps.

#### SEAT BELT

A seat belt with a diagonal shoulder strap (three anchorage points) is deemed to be compliant with the requirement for a seat belt (two anchorage points).

### **AMC3 CAT.IDE.A.205 Seats, seat safety belts, restraint systems and child restraint devices**

#### SEATS FOR MINIMUM REQUIRED CABIN CREW

- (a) Seats for the minimum required cabin crew members should be located near required floor level emergency exits, except if the emergency evacuation of passengers would be enhanced by seating cabin crew members elsewhere. In this case, other locations are acceptable.
- (b) Such seats should be forward-or rearward-facing within 15° of the longitudinal axis of the aeroplane.

### **AMC1 CAT.IDE.A.220 First-aid kit**

#### CONTENT OF FIRST-AID KITS

- (a) First- aid kits should be equipped with appropriate and sufficient medications and instrumentation. However, these kits should be complemented by the operator according to the characteristics of the operation (scope of operation, flight duration, number and demographic s of passengers, etc.).
- (b) The following should be included in the first- aid kit:
  - (1) Equipment
    - (i) bandages (assorted sizes);
    - (ii) burns dressings (unspecified);
    - (iii) wound dressings (large and small);
    - (iv) adhesive dressings (assorted sizes);
    - (v) adhesive tape;
    - (vi) adhesive wound closures;
    - (vii) safety pins;
    - (viii) safety scissors;
    - (ix) antiseptic wound cleaner;
    - (x) disposable resuscitation aid;
    - (xi) disposable gloves;
    - (xii) tweezers: splinter; and
    - (xiii) thermometers (non-mercury).

- (2) Medications
  - (i) simple analgesic (may include liquid form);
  - (ii) antiemetic ;
  - (iii) nasal decongestant;
  - (iv) gastrointestinal antacid, in the case of aeroplanes carrying more than 9 passengers;
  - (v) anti- diarrhoeal medication, in the case of aeroplanes carrying more than 9 passengers; and
  - (vi) antihistamine.
- (3) Other
  - (i) a list of contents in at least two languages (English and one other). This should include information on the effects and side effects of medications carried;
  - (ii) first- aid handbook, current edition;
  - (iii) medic al incident report form;
  - (iv) biohazard disposal bags.
- (4) An eye irrigator, whilst not required to be carried in the first-aid kit, should, where possible, be available for use on the ground.

### **AMC2 CAT.IDE.A.220 First-aid kit**

#### MAINTENANCE OF FIRST-AID KITS

To be kept up to date, first-aid kits should be:

- (a) inspected periodic ally to confirm, to the extent possible, that contents are maintained in the condition necessary for their intended use;
- (b) replenished at regular intervals, in accordance with instructions contained on their labels, or as circumstances warrant; and
- (c) replenished after use in-flight at the first opportunity where replacement items are available.

### **AMC1 CAT.IDE.A.225 Emergency medical kit**

#### CONTENT OF EMERGENCY MEDICAL KIT

- (a) Emergency medic al kits should be equipped with appropriate and sufficient medications and instrumentation. However, these kits should be complemented by the operator according to the characteristic s of the operation (scope of operation, flight duration, number and demographic s of passengers, etc.).
- (b) The following should be included in the emergency medic al kit:
  - (1) Equipment
    - (i) sphygmomanometer — non- mercury;
    - (ii) stethoscope;
    - (iii) syringes and needles;
    - (iv) intravenous cannulae (if intravenous fluids are carried in the first-aid kit, a sufficient supply of intravenous cannulae should be stored there as well);
    - (v) oropharyngeal airways (three sizes);
    - (vi) tourniquet;
    - (vii) disposable gloves;
    - (viii) needle disposal box;
    - (ix) one or more urinary catheter(s), appropriate for either sex, and anaesthetic gel;
    - (x) basic delivery kit;

- (xi) bag-valve masks (masks two sizes: one for adults, one for children);
  - (xii) intubation set;
  - (xiii) aspirator;
  - (xiv) blood glucose testing equipment; and
  - (xv) scalpel.
- (2) Instructions: the instructions should contain a list of contents (medications in trade names and generic names) in at least two languages (English and one other). This should include information on the effects and side effects of medications carried. There should also be basic instructions for use of the medications in the kit and ACLS cards (summarising and depicting the current algorithm for advanced cardiac life support).
- (3) Medications
- (i) coronary vasodilator e.g. glyceriltrinitrate-oral;
  - (ii) antispasmodic
  - (iii) epinephrine/adrenaline 1:1 000 (if a cardiac monitor is carried);
  - (iv) adrenocorticoid — injectable;
  - (v) major analgesic;
  - (vi) diuretic — injectable;
  - (vii) antihistamine — oral and injectable;
  - (viii) sedative/anticonvulsant — injectable, rectal and oral sedative;
  - (ix) medication for hypoglycaemia (e.g. hypertonic glucose);
  - (x) antiemetic ;
  - (xi) atropine — injectable;
  - (xii) bronchial dilator — injectable or inhaled;
  - (xiii) IV fluids in appropriate quantity e.g. sodiumchloride 0.9 % (minimum 250 ml);
  - (xiv) acetylsalicylic acid 300 mg — oral and/or injectable;
  - (xv) antiarrhythmic — if a cardiac monitor is carried;
  - (xvi) antihypertensive medication;
  - (xvii) beta-blocker — oral.
- \* Epinephrine/Adrenaline 1:10 000 can be a dilution of epinephrine 1:1 000
- (4) The carriage of an automated external defibrillator should be determined by the operator on the basis of a risk assessment taking into account the particular needs of the operation.
- (5) The automated external defibrillator should be carried on the aircraft , though not necessarily in the emergency medic al kit.

### **AMC2 CAT.IDE.A.225 Emergency medical kit**

#### CARRIAGE UNDER SECURITY CONDITIONS

The emergency medical kit should be kept in under secure conditions, either in the flight crew compartment or in another locked compartment.

### **AMC3 CAT.IDE.A.225 Emergency medical kit**

#### ACCESS TO EMERGENCY MEDICAL KIT

- (a) When the actual situation on board so requires, the commander should limit access to the emergency medical kit.
- (b) Drugs should be administered by medical doctors, qualified nurses, paramedics or emergency medic al technicians.



- (c) Medical students, student paramedics, student emergency medical technicians or nurses aids should only administer drugs if no person mentioned in (b) is on board the flight and appropriate advice has been received.
- (d) Oral drugs should not be denied in medical emergency situations where no medically qualified persons are on board the flight.

#### **AMC4 CAT.IDE.A.225 Emergency medical kit**

##### MAINTENANCE OF EMERGENCY MEDICAL KIT

To be kept up to date, the emergency medical kit should be:

- (a) inspected periodically to confirm, to the extent possible, that the contents are maintained in the condition necessary for their intended use;
- (b) replenished at regular intervals, in accordance with instructions contained on their labels, or as circumstances warrant; and
- (c) replenished after use-in-flight at the first opportunity where replacement items are available.

#### **GM1 CAT.IDE.A.230 First-aid oxygen**

##### GENERAL

- (a) First-aid oxygen is intended for those passengers who still need to breathe oxygen when the amount of supplemental oxygen required under CAT.IDE.A.235 or CAT.IDE.A.240 has been exhausted.
- (b) When calculating the amount of first-aid oxygen, the operator should take into account the fact that, following a cabin depressurisation, supplemental oxygen as calculated in accordance with Table 1 of CAT.IDE.A.235 and Table 1 of CAT.IDE.A.240 should be sufficient to cope with potential effects of hypoxia for:
  - (1) all passengers when the cabin altitude is above 15 000 ft;
  - (2) at least 30 % of the passengers, for any period when, in the event of loss of pressurisation and taking into account the circumstances of the flight, the pressure altitude in the passenger compartment will be between 14 000 ft and 15 000 ft; and
  - (3) at least 10 % of the passengers for any period in excess of 30 minutes when the pressure altitude in the passenger compartment will be between 10 000 ft and 14 000 ft.
- (c) For the above reasons, the amount of first-aid oxygen should be calculated for the part of the flight after cabin depressurisation during which the cabin altitude is between 8 000 ft and 15 000 ft, when supplemental oxygen may no longer be available.
- (d) Moreover, following cabin depressurisation, an emergency descent should be carried out to the lowest altitude compatible with the safety of the flight. In addition, in these circumstances, the aeroplane should land at the first available aerodrome at the earliest opportunity.
- (e) The conditions above may reduce the period of time during which the first-aid oxygen may be required and consequently may limit the amount of first-aid oxygen to be carried on board.
- (f) Means may be provided to decrease the flow to not less than 2 litres per minute, STPD, at any altitude.

#### **AMC1 CAT.IDE.A.235 Supplemental oxygen — pressurised aeroplanes**

##### DETERMINATION OF OXYGEN

- (a) In the determination of the amount of supplemental oxygen required for the routes to be flown, it is assumed that the aeroplane will descend in accordance with the emergency procedures specified in the operations manual, without exceeding its operating limitations, to a flight altitude that will allow the flight to be completed safely (i.e. flight altitudes ensuring adequate terrain clearance, navigational accuracy, hazardous weather avoidance, etc.).
- (b) The amount of supplemental oxygen should be determined on the basis of cabin pressure altitude, flight duration and on the assumption that a cabin pressurisation failure will occur at the pressure altitude or point of flight that is most critical from the standpoint of oxygen need.
- (c) Following a cabin pressurisation failure, the cabin pressure altitude should be considered to be the same as the aeroplane pressure altitude unless it can be demonstrated to the competent authority that no probable failure of the cabin or pressurisation system will result in a cabin pressure altitude equal to the aeroplane pressure altitude. Under these circumstances, the demonstrated maximum cabin pressure altitude may be used as a basis for determination of oxygen supply.

### **AMC2 CAT.IDE.A.235 Supplemental oxygen — pressurised aeroplanes**

#### **OXYGEN REQUIREMENTS FOR FLIGHT CREW COMPARTMENT SEAT OCCUPANTS AND CABIN CREW IN ADDITION TO THE REQUIRED MINIMUM NUMBER OF CABIN CREW**

- (a) For the purpose of supplemental oxygen supply, flight crew compartment seat occupants who are:
  - (1) supplied with oxygen from the flight crew source of oxygen should be considered as flight crew members; and
  - (2) not supplied with oxygen by the flight crew source of oxygen should be considered as passengers.
- (b) Cabin crew members in addition to the minimum number of cabin crew and additional crew members should be considered as passengers for the purpose of supplemental oxygen supply.

### **AMC1 CAT.IDE.A.235(e) Supplemental oxygen — pressurised aeroplanes**

#### **AEROPLANES NOT CERTIFIED TO FLY ABOVE 25 000 FT**

- (a) With respect to CAT.IDE.A.235(e), the maximum altitude up to which an aeroplane can operate without a passenger oxygen system being installed and capable of providing oxygen to each cabin occupant, should be established using an emergency descent profile that takes into account the following conditions:
  - (1) 17 seconds' time delay for pilot's recognition and reaction, including mask donning, for trouble shooting and configuring the aeroplane for the emergency descent (emergency descent data/charts established by the aeroplane manufacturer and published in the aircraft flight manual (AFM), and/or the AFM should be used to ensure uniform application of the option); and
  - (2) maximum operational speed (VMO) or the airspeed approved in the AFM for emergency descent, (emergency descent data/charts established by the aeroplane manufacturer and published in the AFM, and/or AFM should be used to ensure uniform application of the option), whichever is the less;
- (b) On routes where oxygen is necessary to be carried for 10 % of the passengers for the flight time between 10 000 ft and 13 000 ft, the oxygen should be provided either by:
  - (1) a plug-in or drop-out oxygen system with sufficient outlets and dispensing units uniformly distributed throughout the cabin so as to provide oxygen to each passenger at his/her own discretion when seated on his/her assigned seat; or
  - (2) portable bottles, when a cabin crew member is required on board such flight.

**GM1 CAT.IDE.A.235(b)(1) Supplemental oxygen — pressurised aeroplanes**

## QUICK DONNING MASKS

A quick donning mask is a type of mask that:

- (a) can be placed on the face from its ready position, properly secured, sealed and supplying oxygen upon demand, with one hand and within 5 seconds and will thereafter remain in position, both hands being free;
- (b) can be donned without disturbing eye glasses and without delaying the flight crew member from proceeding with assigned emergency duties;
- (c) once donned, does not prevent immediate communication between the flight crew members and other crew members over the aircraft intercommunication system; and
- (d) does not inhibit radio communications.

**AMC1 CAT.IDE.A.240 Supplemental oxygen — non-pressurised aeroplanes**

## AMOUNT OF SUPPLEMENTAL OXYGEN

The amount of supplemental oxygen for sustenance for a particular operation should be determined on the basis of flight altitudes and flight duration, consistent with the operating procedures, including emergency procedures, established for each operation and the routes to be flown, as specified in the operations manual.

**AMC1 CAT.IDE.A.245 Crew protective breathing equipment**

## PROTECTIVE BREATHING EQUIPMENT (PBE)

The supply for PBE for the flight crew members may be provided by the supplemental oxygen required in CAT.IDE.A.235 or CAT.IDE.A.240.

**AMC1 CAT.IDE.A.250 Hand fire extinguishers**

## NUMBER, LOCATION AND TYPE

- (a) The number and location of hand fire extinguishers should be such as to provide adequate availability for use, account being taken of the number and size of the passenger compartments, the need to minimise the hazard of toxic gas concentrations and the location of lavatories, galleys, etc. These considerations may result in a number of fire extinguishers greater than the minimum required.
- (b) There should be at least one hand fire extinguisher installed in the flight crew compartment and this should be suitable for fighting both flammable fluid and electrical equipment fires. Additional hand fire extinguishers may be required for the protection of other compartments accessible to the crew in flight. Dry chemical fire extinguishers should not be used in the flight crew compartment, or in any compartment not separated by a partition from the flight crew compartment, because of the adverse effect on vision during discharge and, if conductive, interference with electrical contacts by the chemical residues.
- (c) Where only one hand fire extinguisher is required in the passenger compartments, it should be located near the cabin crew member's station, where provided.
- (d) Where two or more hand fire extinguishers are required in the passenger compartments and their location is not otherwise dictated by consideration of CAT.IDE.A.250(b), an extinguisher should be located near each end of the cabin with the remainder distributed throughout the cabin as evenly as is practicable.
- (e) Unless an extinguisher is clearly visible, its location should be indicated by a placard or sign. Appropriate symbols may also be used to supplement such a placard or sign.

**AMC1 CAT.IDE.A.255 Crash axe and crowbar**

## STORAGE OF CRASH AXES AND CROWBARS

Crash axes and crowbars located in the passenger compartment should be stored in a position not visible to passengers.

**AMC1 CAT.IDE.A.260 Marking of break-in points**

## MARKINGS — COLOUR AND CORNERS

- (a) The colour of the markings should be red or yellow and, if necessary, should be outlined in white to contrast with the background.
- (b) If the corner markings are more than 2 m apart, intermediate lines 9 cm x 3 cm should be inserted so that there is no more than 2 m between adjacent markings.

**AMC1 CAT.IDE.A.270 Megaphones**

## LOCATION OF MEGAPHONES

- (a) Where one megaphone is required, it should be readily accessible at the assigned seat of a cabin crew member or crew members other than flight crew.
- (b) Where two or more megaphones are required, they should be suitably distributed in the passenger compartment(s) and readily accessible to crew members assigned to direct emergency evacuations.
- (c) This does not necessarily require megaphones to be positioned such that they can be physically reached by a crew member when strapped in a cabin crew member's seat.

**AMC1 CAT.IDE.A.280 Emergency locator transmitter (ELT)**

## BATTERIES

- (a) All batteries used in ELTs should be replaced (or recharged if the battery is rechargeable) when the equipment has been in use for more than 1 cumulative hour or in the following cases:
  - (1) Batteries specifically designed for use in ELTs and having an airworthiness release certificate (EASA Form 1 or equivalent) should be replaced (or recharged if the battery is rechargeable) before the end of their useful life in accordance with the maintenance instructions applicable to the ELT.
  - (2) Standard batteries manufactured in accordance with an industry standard and not having an airworthiness release certificate (EASA Form 1 or equivalent), when used in ELTs should be replaced (or recharged if the battery is rechargeable) when 50 % of their useful life (or for rechargeable, 50 % of their useful life of charge), as established by the battery manufacturer, has expired.
  - (3) The battery useful life (or useful life of charge) criteria in (1) and (2) do not apply to batteries (such as water-activated batteries) that are essentially unaffected during probable storage intervals.
- (b) The new expiry date for a replaced (or recharged) battery should be legibly marked on the outside of the equipment.

**AMC2 CAT.IDE.A.280 Emergency locator transmitter (ELT)**

## TYPES OF ELT AND GENERAL TECHNICAL SPECIFICATIONS

- (a) The ELT required by this provision should be one of the following:
  - (1) Automatic fixed (ELT(AF)). An automatically activated ELT that is permanently attached to an aircraft and is designed to aid search and rescue (SAR) teams in locating the crash site.
  - (2) Automatic portable (ELT(AP)). An automatically activated ELT, that is rigidly attached to an aircraft before a crash, but is readily removable from the aircraft after a crash. It functions as an ELT during the crash sequence. If the ELT(AP) does not employ an integral antenna, the aircraft-mounted antenna may be disconnected and an auxiliary antenna (stored on the ELT case) attached to the ELT. The ELT can be tethered to a survivor or a life-raft. This type of ELT is intended to aid SAR teams in locating the crash site or survivor(s).

- (3) Automatic deployable (ELT(AD))an ELT that is rigidly attached to the aircraft before the crash and that is automatically ejected, deployed and activated by an impact, and, in some cases, also by hydrostatic sensors. Manual deployment is also provided. This type of ELT should float in water and is intended to aid SAR teams in locating the crash site.
- (4) Survival ELT (ELT(S)). An ELT that is removable from an aircraft, stowed so as to facilitate its ready use in an emergency, and manually activated by a survivor. An ELT(S) may be activated manually or automatically (e.g. by water activation). It should be designed either to be tethered to a life-raft or a survivor.
- (b) To minimise the possibility of damage in the event of crash impact, the automatic ELT should be rigidly fixed to the aircraft structure, as far aft as is practicable, with its antenna and connections arranged so as to maximise the probability of the signal being transmitted after a crash.
- (c) Any ELT carried should operate in accordance with the relevant provisions of ICAO Annex 10, Volume III communications systems and should be registered with the national agency responsible for initiating search and rescue or other nominated agency.

### **GM1 CAT.IDE.A.280 Emergency locator transmitter (ELT)**

#### TERMINOLOGY

'ELT' is a generic term describing equipment that broadcasts distinctive signals on designated frequencies and, depending on application, may be activated by impact or may be manually activated.

### **AMC1 CAT.IDE.A.285 Flight over water**

#### LIFE RAFTS AND EQUIPMENT FOR MAKING DISTRESS SIGNALS

- (a) The following should be readily available with each life-raft:
  - (1) means for maintaining buoyancy;
  - (2) a sea anchor;
  - (3) life- lines and means of attaching one life-raft to another;
  - (4) paddles for life-rafts with a capacity of six or less;
  - (5) means of protecting the occupants from the elements;
  - (6) a water-resistant torch;
  - (7) signalling equipment to make the pyrotechnic distress signals described in ICAO Annex 2, Rules of the Air;
  - (8) 100 g of glucose tablets for each four, or fraction of four, persons that the life-raft is designed to carry;
  - (9) at least 2 litres of drinkable water provided in durable containers or means of making sea water drinkable or a combination of both; and
  - (10) first-aid equipment.
- (b) As far as practicable, items listed in (a) should be contained in a pack.

### **AMC1 CAT.IDE.A.285(e)(4) & CAT.IDE.A.305(a)(2) Flight over water & Survival equipment**

#### SURVIVAL ELT

An ELT(AP) may be used to replace one required ELT(S) provided that it meets the ELT(S) requirements. A water-activated ELT(S) is not an ELT(AP).

### **AMC1 CAT.IDE.A.285(a) Flight over water**

#### ACCESSIBILITY OF LIFE-JACKETS

The life-jacket should be accessible from the seat or berth of the person for whose use it is provided, with a safety belt or restraint system fastened.

**AMC2 CAT.IDE.A.285(a) Flight over water**

## ELECTRIC ILLUMINATION OF LIFE- JACKETS

The means of electric illumination should be a survivor locator light as defined in the applicable ETSO issued by the Libyan CAA or equivalent.

**AMC1 CAT.IDE.A.285(f) Flight over water**

## LOW-FREQUENCY UNDERWATER LOCATING DEVICE

- (a) The underwater locating device should be compliant with ETSO-C200 or equivalent.
- (b) The underwater locating device should not be installed in wings or empennage.

**GM1 CAT.IDE.A.285(a) Flight over water**

## SEAT CUSHIONS

Seat cushions are not considered to be flotation devices.

**AMC1 CAT.IDE.A.305 Survival equipment**

## ADDITIONAL SURVIVAL EQUIPMENT

- (a) The following additional survival equipment should be carried when required:
  - (1) 2 litres of drinkable water for each 50, or fraction of 50, persons on board provided in durable containers;
  - (2) one knife;
  - (3) first- aid equipment; and
  - (4) one set of air/ground codes.
- (b) In addition, when polar conditions are expected, the following should be carried:
  - (1) a means for melting snow;
  - (2) one snow shovel and one ice saw;
  - (3) sleeping bags for use by 1/3 of all persons on board and space blankets for the remainder or space blankets for all passengers on board; and
  - (4) one arctic/polar suit for each crew member.
- (c) If any item of equipment contained in the above list is already carried on board the aeroplane in accordance with another requirement, there is no need for this to be duplicated.

**AMC1 CAT.IDE.A.305(b)(2) Survival equipment**

## APPLICABLE AIRWORTHINESS STANDARD

The applicable airworthiness standard should be CS- 25 or equivalent.

**GM1 CAT.IDE.A.305 Survival equipment**

## SIGNALLING EQUIPMENT

The signalling equipment for making distress signals is described in ICAO Annex 2, Rules of the Air.

**GM2 CAT.IDE.A.305 Survival equipment**

## AREAS IN WHICH SEARCH AND RESCUE WOULD BE ESPECIALLY DIFFICULT

The expression 'areas in which search and rescue would be especially difficult' should be interpreted, in this context, as meaning:

- (a) areas so designated by the authority responsible for managing search and rescue; or
- (b) areas that are largely uninhabited and where:
  - (1) the authority referred to in (a) has not published any information to confirm whether search and rescue would be or would not be especially difficult; and
  - (2) the authority referred to in (a) does not, as a matter of policy, designate areas as being especially difficult for search and rescue.

**AMC1 CAT.IDE.A.325 Headset**

## GENERAL

- (a) A headset consists of a communication device that includes two earphones to receive and a microphone to transmit audio signals to the aeroplane's communication system. To comply with the minimum performance requirements, the earphones and microphone should match the communication system's characteristics and the flight crew compartment environment. The headset should be sufficiently adjustable to fit the pilot's head. Headset boom microphones should be of the noise cancelling type.
- (b) If the intention is to utilise noise cancelling earphones, the operator should ensure that the earphones do not attenuate any aural warnings or sounds necessary for alerting the flight crew on matters related to the safe operation of the aeroplane.

**GM1 CAT.IDE.A.325 Headset**

## GENERAL

The term 'headset' includes any aviation helmet incorporating headphones and microphone worn by a flight crew member.

**AMC1 CAT.IDE.A.345 Communication and navigation equipment for operations under IFR or under VFR over routes not navigated by reference to visual landmarks**

## TWO INDEPENDENT MEANS OF COMMUNICATION

Whenever two independent means of communication are required, each system should have an independent antenna installation, except where rigidly supported non-wire antennae or other antenna installations of equivalent reliability are used.

**AMC2 CAT.IDE.A.345 Communication and navigation equipment for operations under IFR or under VFR over routes not navigated by reference to visual landmarks**

## ACCEPTABLE NUMBER AND TYPE OF COMMUNICATION AND NAVIGATION EQUIPMENT

- (a) An acceptable number and type of communication and navigation equipment is:
  - (1) one VHF omnidirectional radio range (VOR) receiving system, one automatic direction finder (ADF) system, one distance measuring equipment (DME), except that an ADF system need not be installed provided that the use of ADF is not required in any phase of the planned flight;
  - (2) one instrument landing system (ILS) or microwave landing system (MLS) where ILS or MLS is required for approach navigation purposes;
  - (3) one marker beacon receiving system where a marker beacon is required for approach navigation purposes;
  - (4) area navigation equipment when area navigation is required for the route being flown (e.g. equipment required by Part-SPA);
  - (5) an additional DME system on any route, or part thereof, where navigation is based only on DME signals;
  - (6) an additional VOR receiving system on any route, or part thereof, where navigation is based only on VOR signals; and
  - (7) an additional ADF system on any route, or part thereof, where navigation is based only on non-directional beacon (NDB) signals.
- (b) Aeroplanes may be operated without the navigation equipment specified in (6) and (7) provided they are equipped with alternative equipment. The reliability and the accuracy of alternative equipment should allow safe navigation for the intended route.

- (c) The operator conducting extended range operations with two-engined aeroplanes (ETOPS) should ensure that the aeroplanes have a communication means capable of communicating with an appropriate ground station at normal and planned contingency altitudes. For ETOPS routes where voice communication facilities are available, voice communications should be provided. For all ETOPS operations beyond 180 minutes, reliable communication technology, either voice- based or data link, should be installed. Where voice communication facilities are not available and where voice communication is not possible or is of poor quality, communications using alternative systems should be ensured.
- (d) To perform IFR operations without an ADF system installed, the operator should consider the following guidelines on equipment carriage, operational procedures and training criteria.
  - (1) ADF equipment may only be removed from or not installed in an aeroplane intended to be used for IFR operations when it is not essential for navigation, and provided that alternative equipment giving equivalent or enhanced navigation capability is carried. This may be accomplished by the carriage of an additional VOR receiver or a GNSS receiver approved for IFR operations.
  - (2) For IFR operations without ADF, the operator should ensure that:
    - (i) route segments that rely solely on ADF for navigation are not flown;
    - (ii) ADF/NDB procedures are not flown;
    - (iii) the minimum equipment list (MEL) has been amended to take account of the non- carriage of ADF;
    - (iv) the operations manual does not refer to any procedures based on NDB signals for the aeroplanes concerned; and
    - (v) flight planning and dispatch procedures are consistent with the above mentioned criteria.
    - (vi) The removal of ADF should be taken into account by the operator in the initial and recurrent training of flight crew.
- (e) VHF communication equipment, ILS localiser and VOR receivers installed on aeroplanes to be operated in IFR should comply with the following FM immunity performance standards:
  - (1) ICAO Annex 10, Volume I - Radio Navigation Aids, and Volume III, Part II - Voice Communications Systems; and
  - (2) acceptable equipment standards contained in EUROCAE Minimum Operational Performance Specifications, documents ED- 22B for VOR receivers, ED- 23B for VHF communication receivers and ED- 46B for LOC receivers and the corresponding Radio Technical Commission for Aeronautics (RTCA) documents DO- 186, DO- 195 and DO- 196.

### **AMC3 CAT.IDE.A.345 Communication and navigation equipment for operations under IFR or under VFR over routes not navigated by reference to visual landmarks**

#### FAILURE OF A SINGLE UNIT

Required communication and navigation equipment should be installed such that the failure of any single unit required for either communication or navigation purposes, or both, will not result in the failure of another unit required for communications or navigation purposes.

### **AMC4 CAT.IDE.A.345 Communication and navigation equipment for operations under IFR or under VFR over routes not navigated by reference to visual landmarks**

#### LONG RANGE COMMUNICATION SYSTEMS

- (a) The long range communication system should be either a high frequency/HF- system or another two-way communication system if allowed by the relevant airspace procedures.



- (b) When using one communication system only, the competent authority may restrict the minimum navigation performance specifications (MNPS) approval to the use of the specific routes.

### **GM1 CAT.IDE.A.345(c) Communication and navigation equipment for operations under IFR or under VFR over routes not navigated by reference to visual landmarks**

#### SHORT HAUL OPERATIONS

The term 'short haul operations' refers to operations not crossing the North Atlantic.

### **GM1 CAT.IDE.A.345 Communication and navigation equipment for operations under IFR or under VFR over routes not navigated by reference to visual landmarks**

#### APPLICABLE AIRSPACE REQUIREMENTS

For aeroplanes being operated under European air traffic control, the applicable airspace requirements include the Single European Sky legislation.

### **AMC1 CAT.IDE.A.350 Transponder**

#### SSR TRANSPONDER

- (a) The secondary surveillance radar (SSR) transponders of aeroplanes being operated under European air traffic control should comply with any applicable Single European Sky legislation.
- (b) If the Single European Sky legislation is not applicable, the SSR transponders should operate in accordance with the relevant provisions of Volume IV of ICAO Annex 10.

### **AMC1 CAT.IDE.A.355 Electronic navigation data management**

#### ELECTRONIC NAVIGATION DATA PRODUCTS

- (a) When the operator of a complex motor-powered aeroplane uses a navigation database that supports an airborne navigation application as a primary means of navigation, the navigation database supplier should hold a Type 2 letter of acceptance (LoA), or equivalent.
- (b) If this airborne navigation application is needed for an operation requiring a specific approval in accordance with Part-SPA, the operator's procedures should be based upon the Type 2 LoA acceptance process.

### **GM1 CAT.IDE.A.355 Electronic navigation data management**

#### LETTERS OF ACCEPTANCE AND STANDARDS FOR ELECTRONIC NAVIGATION DATA PRODUCTS

- (a) A Type 2 LoA is issued by the Libyan CAA in accordance with the Libyan CAA's Opinion No 01/2005 on The Acceptance of Navigation Database Suppliers. The definitions of navigation database, navigation database supplier, data application integrator, Type 1 LoA and Type 2 LoA can be found in Opinion No 01/2005.
- (b) Equivalent to a Type 2 LoA is the FAA Type 2 LoA, issued in accordance with the Federal Aviation Administration (FAA) Advisory Circular AC 20-153 or AC 20-153A, and the Transport Canada Civil Aviation (TCCA) 'Acknowledgement Letter of an Aeronautical Data Process', which uses the same basis.
- (c) EUROCAE ED-76/Radio Technical Commission for Aeronautics (RTCA) DO- 200A Standards for Processing Aeronautical Data contains guidance relating to the processes that the supplier may follow.

## SECTION 2 — Helicopters

### GM1 CAT.IDE.H.100(a) Instruments and equipment — general

REQUIRED INSTRUMENTS AND EQUIPMENT THAT DO NOT NEED TO BE APPROVED IN ACCORDANCE WITH LCAR's

The functionality of non- installed instruments and equipment required by this Subpart and that do not need an equipment approval, as listed in CAT.IDE.H.100(a), should be checked against recognised industry standards appropriate to the intended purpose. The operator is responsible for ensuring the maintenance of these instruments and equipment.

### GM1 CAT.IDE.H.100(b) Instruments and equipment — general

NOT REQUIRED INSTRUMENTS AND EQUIPMENT THAT DO NOT NEED TO BE APPROVED IN ACCORDANCE WITH LCAR's, BUT ARE CARRIED ON A FLIGHT

- (a) The provision of this paragraph does not exempt any installed instrument or item of equipment from complying with LCAR's. In this case, the installation should be approved as required in appropriate LCAR(s) and should comply with the applicable airworthiness codes as required under that Regulation.
- (b) The failure of additional non-installed instruments or equipment not required by this Part or the airworthiness codes as required under LCAR's or any applicable airspace requirements should not adversely affect the airworthiness and/or the safe operation of the aircraft. Examples may be the following:
  - (1) portable electronic flight bag (EFB);
  - (2) portable electronic devices carried by flight crew or cabin crew; and
  - (3) non-installed passenger entertainment equipment.

### GM1 CAT.IDE.H.100(d) Instruments and equipment — general

POSITIONING OF INSTRUMENTS

This requirement implies that whenever a single instrument is required to be installed in a helicopter operated in a multi-crew environment, the instrument needs to be visible from each flight crew station.

### AMC1 CAT.IDE.H.125 & CAT.IDE.H.130 Operations under VFR by day & Operations under IFR or at night — flight and navigational instruments and associated equipment and

INTEGRATED INSTRUMENTS

- (a) Individual equipment requirements may be met by combinations of instruments or by integrated flight systems or by a combination of parameters on electronic displays, provided that the information so available to each required pilot is not less than the required in the applicable operational requirements, and the equivalent safety of the installation has been shown during type certification approval of the helicopter for the intended type of operation.
- (b) The means of measuring and indicating slip, helicopter attitude and stabilised helicopter heading may be met by combinations of instruments or by integrated flight director systems, provided that the safeguards against total failure, inherent in the three separate instruments, are retained.

**AMC1 CAT.IDE.H.125(a)(1)(i) & CAT.IDE.H.130(a)(1) Operations under VFR by day & Operations under IFR or at night — flight and navigational instruments and associated equipment****MEANS OF MEASURING AND DISPLAYING MAGNETIC HEADING**

The means of measuring and displaying magnetic direction should be a magnetic compass or equivalent.

**AMC1 CAT.IDE.H.125(a)(1)(ii) & CAT.IDE.H.130(a)(2) Operations under VFR by day & Operations under IFR or at night — flight and navigational instruments and associated equipment****MEANS OF MEASURING AND DISPLAYING THE TIME**

An acceptable means of compliance is a clock displaying hours, minutes and seconds, with a sweep-second pointer or digital presentation.

**AMC1 CAT.IDE.H.125(a)(1)(iii) & CAT.IDE.H.130(b) Operations under VFR by day & Operations under IFR or at night — flight and navigational instruments and associated equipment****CALIBRATION OF THE MEANS OF MEASURING AND DISPLAYING PRESSURE ALTITUDE**

The instrument measuring and displaying pressure altitude should be of a sensitive type calibrated in feet (ft), with a sub-scale setting, calibrated in hectopascals/millibars, adjustable for any barometric pressure likely to be set during flight.

**AMC1 CAT.IDE.H.125(a)(1)(iv) & CAT.IDE.H.130(a)(43) Operations under VFR by day & Operations under IFR or at night — flight and navigational instruments and associated equipment****CALIBRATION OF THE INSTRUMENT INDICATING AIRSPEED**

The instrument indicating airspeed should be calibrated in knots (kt).

**AMC1 CAT.IDE.H.125(a)(1)(vii) & CAT.IDE.H.130(a)(8) Operations under VFR by day & Operations under IFR or at night — flight and navigational instruments and associated equipment****OUTSIDE AIR TEMPERATURE**

- (a) The means of displaying outside air temperature should be calibrated in degrees Celsius.
- (b) The means of displaying outside air temperature may be an air temperature indicator that provides indications that are convertible to outside air temperature.

**AMC1 CAT.IDE.H.125(b) & CAT.IDE.H.130(h) Operations under VFR by day & Operations under IFR or at night — flight and navigational instruments and associated equipment and****MULTI- PILOT OPERATIONS — DUPLICATE INSTRUMENTS**

Duplicate instruments should include separate displays for each pilot and separate selectors or other associated equipment where appropriate.

**AMC1 CAT.IDE.H.125(c)(2) & CAT.IDE.H.130(a)(7) Operations under VFR by day & Operations under IFR or at night — flight and navigational instruments and associated equipment****STABILISED HEADING**

Stabilised heading should be achieved for VFR flights by a gyroscopic heading indicator, whereas for IFR flights, this should be achieved through a magnetic gyroscopic heading indicator.

### **AMC1 CAT.IDE.H.125(d) & CAT.IDE.H.130(d) Operations under VFR by day & Operations under IFR or at night operations — flight and navigational instruments and associated equipment**

#### MEANS OF PREVENTING MALFUNCTION DUE TO CONDENSATION OR ICING

The means of preventing malfunction due to either condensation or icing of the airspeed indicating system should be a heated pitot tube or equivalent.

### **AMC1 CAT.IDE.H.130(e) Operations under IFR or at night — flight and navigational instruments and associated equipment**

#### MEANS OF INDICATING FAILURE OF THE AIRSPEED INDICATING SYSTEM'S MEANS OF PREVENTING MALFUNCTION DUE TO EITHER CONDENSATION OR ICING

A combined means of indicating failure of the airspeed indicating system's means of preventing malfunction due to either condensation or icing is acceptable provided that it is visible from each flight crew station and that there it is a means to identify the failed heater in systems with two or more sensors.

### **AMC1 CAT.IDE.H.130(f)(6) Operations under IFR or at night — flight and navigational instruments and associated equipment**

#### ILLUMINATION OF STANDBY MEANS OF MEASURING AND DISPLAYING ATTITUDE

The standby means of measuring and displaying attitude should be illuminated so as to be clearly visible under all conditions of daylight and artificial lighting.

### **AMC1 CAT.IDE.H.130(i) Operations under IFR or at night — flight and navigational instruments and associated equipment**

#### CHART HOLDER

An acceptable means of compliance with the chart holder requirement is to display a pre-composed chart on an electronic flight bag (EFB).

### **GM1 CAT.IDE.H.125 & CAT.IDE.H.130 Operations under VFR by day & Operations under IFR or at night — flight and navigational instruments and associated equipment**

#### SUMMARY TABLE

Table 1: Flight and navigational instruments and associated equipment

SERIAL		FLIGHTS UNDER VFR		FLIGHTS UNDER IFR OR AT NIGHT	
		SINGLE-PILOT	TWO PILOTS REQUIRED	SINGLE- PILOT	TWO PILOTS REQUIRED
(a)		(b)	(c)	(d)	(e)
1	Magnetic direction	1	1	1	1
2	time	1	1	1	1
3	Pressure altitude	1	2	2 Note (1)	2
4	Indicated airspeed	1	2	1	2
5	Vertical speed	1	2	1	2

6	Slip	1	2	1	2
7	Attitude	1 Note (2)	2 Note(2)	1	2
8	Stabilised direction	1 Note (2)	2 Note(2)	1	2
9	Outside air temperature	1	1	1	1
10	Airspeed icing protection	1 Note (3)	2 Note (3)	1	2
11	Airspeed icing protection failure			1 Note (4)	2 Note (4)
12	Static pressure source			2	2
13	Standby attitude			1 Note (5)	1 Note (5)
14	Chart holder			1 Note (6)	1 Note (6)

*Note (1) For single-pilot night operation under VFR, one means of measuring and displaying pressure altitude may be substituted by a means of measuring and displaying radio altitude.*

*Note (2) Applicable only to helicopters with a maximum certified take -off mass (MC TOM) of more than 3 175 kg; or helicopters operated over water when out of sight of land or when the visibility is less than 1 500 m.*

*Note (3) Applicable only to helicopters with an MCTOM of more than 3 175 kg, or with an MOPSC of more than 9.*

*Note (4) The pitot heater failure annunciation applies to any helicopter issued with an individual CofA on or after 1 August 1999. It also applies before that date when: the helicopter has a MCTOM of more than 3 175 kg and an MOPSC of more than 9.*

*Note (5) For helicopters with an MCTOM of more than 3 175 kg, CS 29.1303(g) may require either a gyroscopic rate-of-turn indicator combined with a slip -skid indicator (turn and bank indicator) or a standby attitude indicator satisfying the requirements. In any case, the original type certification standard should be referred to determine the exact requirement.*

*Note (6) Applicable only to helicopters operating under IFR.*

### **AMC1 CAT.IDE.H.145 Radio altimeters**

#### **AUDIO WARNING DEVICE**

The audio warning required in CAT.IDE.H.145 should be a voice warning.

### **AMC1 CAT.IDE.H.160 Airborne weather detecting equipment**

#### **GENERAL**

The airborne weather detecting equipment should be an airborne weather radar.

**AMC1 CAT.IDE.H.170 Flight crew interphone system**

## TYPE OF FLIGHT CREW INTERPHONE

The flight crew interphone system should not be of a handheld type.

**AMC1 CAT.IDE.H.175 Crew member interphone system**

## SPECIFICATIONS

The crew member interphone system should:

- (a) operate independently of the public address system except for handsets, headsets, microphones, selector switches and signalling devices;
- (b) in the case of helicopters where at least one cabin crew member is required, be readily accessible for use at required cabin crew stations close to each separate or pair of floor level emergency exits;
- (c) in the case of helicopters where at least one cabin crew member is required, have an alerting system incorporating aural or visual signals for use by flight and cabin crew;
- (d) have a means for the recipient of a call to determine whether it is a normal call or an emergency call that uses one or a combination of the following:
  - (1) lights of different colours;
  - (2) codes defined by the operator (e.g. different number of rings for normal and emergency calls); or
  - (3) any other indicating signal specified in the operations manual;
- (e) provide a means of two-way communication between the flight crew compartment and each crew member station; and
- (f) be readily accessible for use from each required flight crew station in the flight crew compartment.

**AMC1 CAT.IDE.H.180 Public address system**

## SPECIFICATIONS

The public address system should:

- (a) operate independently of the interphone systems except for handsets, headsets, microphones, selector switches and signalling devices;
- (b) be readily accessible for immediate use from each required flight crew station;
- (c) have, for each floor level passenger emergency exit that has an adjacent cabin crew seat, a microphone operable by the seated cabin crew member, except that one microphone may serve more than one exit, provided the proximity of exits allows unassisted verbal communication between seated cabin crew members;
- (d) be operable within ten seconds by a cabin crew member at each of those stations;
- (e) be audible at all passenger seats, lavatories, cabin crew seats and work stations and any other location or compartment that may be occupied by persons; and
- (f) following a total failure of the normal electrical generating system, provide reliable operation for a minimum of ten minutes.

**AMC1 CAT.IDE.H.185 Cockpit voice recorder**

## OPERATIONAL PERFORMANCE REQUIREMENTS

For helicopters first issued with an individual CofA on or after 1 January 2016, the operational performance requirements for cockpit voice recorders (CVRs) should be those laid down in EUROCAE Document ED- 112 (Minimum Operational Performance Specification for Crash Protected Airborne Recorder Systems) dated March 2003, including amendments No 1 and No 2, or any later equivalent standard produced by EUROCAE.

**AMC1 CAT.IDE.H.190 Flight data recorder**

OPERATIONAL PERFORMANCE REQUIREMENTS FOR HELICOPTERS HAVING AN MCTOM OF MORE THAN 3 175 KG AND FIRST ISSUED WITH AN INDIVIDUAL CofA ON OR AFTER 1 JANUARY 2016

- (a) The operational performance requirements for flight data recorders (FDRs) should be those laid down in EUROCAE Document ED- 112 (Minimum Operational Performance Specification for Crash Protected Airborne Recorder Systems) dated March 2003, including amendments No 1 and No 2, or any later equivalent standard produced by EUROCAE.
- (b) The FDR should, with reference to a timescale, record:
- (1) the parameters listed in Table 1 below;
  - (2) the additional parameters listed in Table 2 below, when the information data source for the parameter is used by helicopter systems or is available on the instrument panel for use by the flight crew to operate the helicopter; and
  - (3) any dedicated parameters related to novel or unique design or operational characteristics of the helicopter as determined by the Libyan CAA.
- (c) The FDR parameters should meet, as far as practicable, the performance specifications (range, sampling intervals, accuracy limits and minimum in read-out) defined in the operational performance requirements and specifications of EUROCAE Document ED-112, including amendments No 1 and No 2, or any later equivalent standard produced by EUROCAE.
- (d) FDR systems for which some recorded parameters do not meet the performance specifications of EUROCAE Document ED- 112 may be acceptable to the Libyan CAA.

Table 1: FDR — all helicopters

No*	Parameter
1	Time or relative time count
2	Pressure altitude
3	Indicated airspeed or calibrated airspeed
4	Heading
5	Normal acceleration
6	Pitch attitude
7	Roll attitude
8	Manual radio transmission keying CVR/FDR synchronisation reference
9	Power on each engine
9a	Free power turbine speed (NF)
9b	Engine torque
9c	Engine gas generator speed (NG)
9d	Cockpit power control position
9e	Other parameters to enable engine power to be determined
10a	Main rotor speed
10b	Rotor brake (if installed)

11	Primary flight controls — Pilot input and/or control output position (if applicable)
11a	Collective pitch
11b	Longitudinal cyclic pitch
11c	Lateral cyclic pitch
11d	Tail rotor pedal
11e	Controllable stabilator (if applicable)
11f	Hydraulic selection
12	Hydraulics low pressure (each system should be recorded.)
13	Outside air temperature
18	Yaw rate or yaw acceleration
20	Longitudinal acceleration (body axis)
21	Lateral acceleration
25	Marker beacon passage
26	Warnings — a disc rete should be recorded for the master warning, gearbox low oil pressure and stability augmentation system failure. Other 'red' warnings should be recorded where the warning condition cannot be determined from other parameters or from the cockpit voice recorder.
27	Each navigation receiver frequency selection
37	Engine control modes

\* *The number in the left hand column reflects the serial numbers depicted in EUROCAE Document ED-112*



Table 2: Helicopters for which the data source for the parameter is either used by helicopter systems or is available on the instrument panel for use by the flight crew to operate the helicopter

No *	Parameter
14	AFCS mode and engagement status
15	Stability augmentation system engagement (each system should be recorded)
16	Main gear box oil pressure
17 17a 17b 17c	Gear box oil temperature Main gear box oil temperature Intermediate gear box oil temperature Tail rotor gear box oil temperature
19	Indicated sling load force (if signals readily available)
22	Radio altitude
23 23a 23b 23c	Vertical deviation — the approach aid in use should be recorded. ILS glide path MLS elevation GNSS approach path
24 24a 24b 24c	Horizontal deviation — the approach aid in use should be recorded. ILS localiser MLS azimuth GNSS approach path
28	DME 1 & 2 distances
29 29a 29b 29c 29d 29e 29f	Navigation data Drift angle Wind speed Wind direction Latitude Longitude Ground speed
30	Landing gear or gear selector position
31	Engine exhaust gas temperature (T 4)
32	Turbine inlet temperature (TIT/ITT)
33	Fuel contents
34	Altitude rate (vertical speed) — only necessary when available from cockpit instruments

35	Ice detection
36 36a 36b 36c 36d 36e	Helicopter health and usage monitor system(HUMS) Engine data Chip detector Track timing Exceedance discrettes Broadband average engine vibration
38 38a 38b	Selected barometric setting — to be recorded for helicopters where the parameter is displayed electronically Pilot Co-pilot
39	Selected altitude (all pilot selectable modes of operation) — to be recorded for the helicopters where the parameter is displayed electronically
40	Selected speed (all pilot selectable modes of operation) — to be recorded for the helicopters where the parameter is displayed electronically
41	Selected Mach (all pilot selectable modes of operation) — to be recorded for the helicopters where the parameter is displayed electronically
42	Selected vertical speed (all pilot selectable modes of operation) — to be recorded for the helicopters where the parameter is displayed electronically
43	Selected heading (all pilot selectable modes of operation) — to be recorded for the helicopters where the parameter is displayed electronically
44	Selected flight path (all pilot selectable modes of operation) — to be recorded for the helicopters where the parameter is displayed electronically
45	Selected decision height (all pilot selectable modes of operation) — to be recorded for the helicopters where the parameter is displayed electronically
46	EFIS display format
47	Multi-function/engine/alerts display format
48	Event marker

\* *The number in the left hand column reflects the serial numbers depicted in EUROCAE Document ED-112*

## **AMC2 CAT.IDE.H.190 Flight data recorder**

LIST OF PARAMETERS TO BE RECORDED FOR HELICOPTERS HAVING AN MCTOM OF MORE THAN 3 175 KG AND FIRST ISSUED WITH AN INDIVIDUAL COFA ON OR AFTER 1 AUGUST 1999 AND BEFORE 1 JANUARY 2016 AND HELICOPTERS HAVING AN MCTOM OF MORE THAN 7 000 KG OR AN MOPSC OF MORE THAN 9 AND FIRST ISSUED WITH AN INDIVIDUAL COFA ON OR AFTER 1 JANUARY 1989 AND BEFORE 1 AUGUST 1999

- (a) The FDR should, with reference to a timescale, record:
- (1) for helicopters with an MCTOM between 3 175 kg and 7 000 kg the parameters listed in Table 1 below;

- (2) for helicopters with an MCTOM of more than 7 000 kg the parameters listed in Table 2 below;
  - (3) for helicopters equipped with electronic display systems, the additional parameters listed in Table 3 below; and
  - (4) any dedicated parameters relating to novel or unique design or operational characteristics of the helicopter.
- (b) When determined by the Libyan CAA, the FDR of helicopters with an MCTOM of more than 7 000 kg does not need to record parameter 19 of Table 2 below, if any of the following conditions are met:
- (1) the sensor is not readily available; or
  - (2) a change is required in the equipment that generates the data.
- (c) Individual parameters that can be derived by calculation from the other recorded parameters need not to be recorded, if agreed by the competent authority.
- (d) The parameters should meet, as far as practicable, the performance specifications (range, sampling intervals, accuracy limits and resolution in read-out) defined in AMC3 CAT.IDE.H.190.
- (e) If recording capacity is available, as many of the additional parameters as possible specified in table II-A.2 of EUROCAE Document ED 112 dated March 2003 should be recorded.
- (f) For the purpose of this AMC, a sensor is considered 'readily available' when it is already available or can be easily incorporated.

Table 1: Helicopters with an MCTOM of 7 000 kg or less

No	Parameter
1	Time or relative time count
2	Pressure altitude
3	Indicated airspeed or calibrated airspeed
4	Heading
5	Normal acceleration
6	Pitch attitude
7	Roll attitude
8	Manual radio transmission keying
9	Power on each engine (free power turbine speed and engine torque)/cockpit power control position (if applicable)
10 10b	Main rotor speed Rotor brake (if installed)

11	Primary flight controls — pilot input and control output position (if applicable)
11a	Collective pitch
11b	Longitudinal cyclic pitch
11c	Lateral cyclic pitch
11d	Tail rotor pedal
11e	Controllable stabilator
11f	Hydraulic selection
13	Outside air temperature
14	Autopilot engagement status
15	Stability augmentation system engagement
26	Warnings

Table 2: Helicopters with an MCTOM of more than 7 000 kg

No	Parameter
1	Time or relative time count
2	Pressure altitude
3	Indicated airspeed or calibrated airspeed
4	Heading
5	Normal acceleration
6	Pitch attitude
7	Roll attitude
8	Manual radio transmission keying
9	Power on each engine (free power turbine speed and engine torque)/cockpit power control position (if applicable)
10a	Main rotor speed
10b	Rotor brake (if installed)

11	Primary flight controls — pilot input and control output position (if applicable)
11a	Collective pitch
11b	Longitudinal cyclic pitch
11c	Lateral cyclic pitch
11d	Tail rotor pedal
11e	Controllable stabilator
11f	Hydraulic selection
12	Hydraulics low pressure
13	Outside air temperature
14	AFCS mode and engagement status
15	Stability augmentation system engagement
16	Main gear box oil pressure
17	Main gear box oil temperature
18	Yaw rate or yaw acceleration
19	Indicated sling load force (if installed)
20	Longitudinal acceleration (body axis)
21	Lateral acceleration
22	Radio altitude
23	Vertical beam deviation (ILS glide path or MLS elevation)
24	Horizontal beam deviation (ILS localiser or MLS azimuth)
25	Marker beacon passage
26	Warnings
27	Reserved (navigation receiver frequency selection is recommended)
28	Reserved (DME distance is recommended)
29	Reserved (navigation data are recommended)
30	Landing gear or gear selector position

Table 3: Helicopters equipped with electronic display systems

No	Parameter
38	Selected barometric setting (each pilot station)
39	Selected altitude
40	Selected speed
41	Selected Mach
42	Selected vertical speed
43	Selected heading
44	Selected flight path
45	Selected decision height
46	EFIS display format
47	Multi-function/engine/alerts display format

**AMC3 CAT.IDE.H.190 Flight data recorder**

PERFORMANCE SPECIFICATIONS FOR THE PARAMETERS TO BE RECORDED FOR HELICOPTERS HAVING AN MCTOM OF MORE THAN 3 175 KG AND FIRST ISSUED WITH AN INDIVIDUAL C of A ON OR AFTER 1 AUGUST 1999 AND BEFORE 1 JANUARY 2016 AND HELICOPTERS HAVING AN MCTOM OF MORE THAN 7 000 KG OR AN MOPSC OF MORE THAN 9 AND FIRST ISSUED WITH AN INDIVIDUAL CofA ON OR AFTER 1 JANUARY 1989 AND BEFORE 1 AUGUST 1999

No	Parameter	Range	Sampling interval in seconds	Accuracy Limits (sensor input compared to FDR read out)	Minimum Resolution in read out	Remarks
1	Time or relative time count					
1a or	Time	24 hours	4	± 0.125 % per hour	1 second	(a) UTC time preferred where available.
1b	Relative Time Count	0 to 4 095	4	± 0.125 % per hour		(b) Counter increments every 4 seconds of system operation.
2	Pressure altitude	-1 000 ft to 20 000 ft	1	±100 ft to ±700 ft Refer to table II.A-2 of EUROCAE Document ED-112	25 ft	
3	Indicated airspeed or calibrated airspeed	As the installed measuring system	1	± 5 % or ± 10 kt, whichever is greater	1 kt	
4	Heading	360 °	1	± 5°	1 °	
5	Normal acceleration	- 3 g to + 6 g	0.125	± 0.2 g in addition to a maximum offset of ± 0.3 g	0.01 g	The resolution may be rounded from 0.01 g to 0.05 g, provided that one sample is recorded at full resolution at least every 4 seconds.

6	Pitch attitude	100 % of usable range	0.5	± 2 degrees	0.8 degree	
7	Roll attitude	± 60 ° or 100 % of usable range from installed system if greater	0.5	± 2 degrees	0.8 degree	
8	Manual radio transmission keying	Discrete(s)	1	-	-	Preferably each crew member but one discrete acceptable for all transmissions.
9	Power on each engine	Full range	Each engine each second	± 5 %	1 % of full range	Sufficient parameters, e.g. Power Turbine Speed and Engine Torque should be recorded to enable engine power to be determined. A margin for possible overspeed should be provided. Data may be
9a	Power turbine speed	Maximum range				
9b	Engine torque	Maximum range				
9c	Cockpit power control position	Full range or each discrete position	Each control each second	±2 % or sufficient to determine any gated position	2 % of full range	obtained from cockpit indicators used for aircraft certification. Parameter 9c is required for helicopters with non-mechanically linked cockpit-engine controls
10	Rotor					
10a	Main rotor speed	Maximum range	1	± 5 %	1 % of full range	
10b	Rotor brake	Discrete	1			Where available
11	Primary flight controls - Pilot input and/or* control output position					* For helicopters that can demonstrate the capability of deriving either the control input or control movement (one from the other) for all modes of operation



11a	Collective pitch	Full Range	0.5	± 3 %	1 % of full range	and flight regimes, the 'or' applies. For helicopters with non-mechanical control systems the 'and' applies. Where the input controls for each pilot can be operated independently, both inputs will need to be recorded.
11b	Longitudinal cyclic pitch		0.5			
11c	Lateral cyclic pitch		0.5			
11d	Tail rotor pedal		0.5			
11e	Controllable stabilator		0.5			
11f	Hydraulic selection	Discretes	1	-	-	
12	Outside temperature	air Available range from installed system	2	± 2 °C	0.3°C	
13	Autopilot engagement status	Discrete(s)	1			Where practicable, discretes should show which primary modes are controlling the flight path of the helicopter
14	Stability augmentation system engagement	Discrete(s)	1			
15	Warnings	Discrete(s)	1	-	-	A disc rete should be recorded for the master warning, low hydraulic pressure (each system) gearbox low oil pressure and SAS fault status. Other 'red' warnings should be recorded where the warning condition cannot be determined from other parameters or from the cockpit voice recorder.

Table 2: Helicopters with an MCTOM of more than 7 000 kg

N°	Parameter	Range	Sampling interval in seconds	Accuracy Limits (sensor input compared to FDR read out)	Minimum Resolution in read out	Remarks
1	Time or relative time count					
1a or	Time	24 hours	4	± 0.125 % per hour	1 second	(a) UTC time preferred where available.
1b	Relative time count	0 to 4095	4	± 0.125 % per hour		(b) Counter increments every 4 seconds of system operation.
2	Pressure altitude	-1 000 ft to maximum certificated altitude of aircraft +5 000	1	± 100 ft to ± 700 ft Refer to table II-A.3 EUROCAE Document ED-112	5 ft	Should be obtained from the air data computer when installed.
3	Indicated airspeed or calibrated airspeed	As the installed measuring system	1	± 3 %	1 kt	Should be obtained from the air data computer when installed.
4	Heading	360 degrees	1	± 2 degrees	0.5 degree	
5	Normal acceleration	-3 g to +6 g	0.125	1 % of range excluding a datum error of 5 %	0.004 g	The recording resolution may be rounded from 0.004 g to 0.01 g provided that one sample is recorded at full resolution at least every 4 seconds.
6	Pitch attitude	± 75 degrees	0.5	± 2 degrees	0.5 degree	
7	Roll attitude	± 180 degrees	0.5	± 2 degrees	0.5 degree	.

8	Manual radio transmission Keying and CVR/FDR	Discrete(s)	1	-	-	Preferably each crew member but one discrete acceptable for all transmissions provided that
	synchronisation reference					the replay of a recording made by any required recorder can be synchronised in time with any other required recording to within 1 second.
9	Power on each engine	Full range	Each engine each second	$\pm 2\%$	0.2 % of full range	Sufficient parameters e.g. Power Turbine Speed and engine torque should be recorded to enable engine power to be determined. A margin for possible overspeed should be provided.
9a	Free power turbine speed (NF)	0-130 %				
9b	Engine torque	Full range				
9c	Cockpit power control position	Full range or each discrete position	Each control each second	$\pm 2\%$ or sufficient to determine any gated position	2 % of full range	Parameter 9c is required for helicopters with non-mechanically linked cockpit-engine controls
10 10a	Rotor Main rotor speed	50 to 130 %	0.5	2 %	0.3 % of full range	
10b	Rotor brake	Discrete	1			Where available

11	Primary flight controls - Pilot input and/or* control output position					* For helicopters that can demonstrate the capability of deriving either the control input or control movement (one from the other) for all modes of operation and flight regimes, the 'or' applies. For helicopters with non-mechanical control systems, the 'and' applies. Where the input controls for each pilot can be operated independently, both inputs will need to be recorded
----	--	--	--	--	--	--

N°	Parameter	Range	Sampling interval in seconds	Accuracy Limits (sensor input compared to FDR read out)	Minimum Resolution in read out	Remarks
11a	Collective pitch	Full range	0.5	± 3 % unless higher accuracy is uniquely required	0.5 % of operating range	input or control movement (one from the other) for all modes of operation and flight regimes, the 'or' applies. For helicopters with non-mechanical control systems, the 'and' applies. Where the input controls for each pilot can be operated independently, both inputs will need to be recorded.
11b	Longitudinal cyclic pitch		0.5			
11c	Lateral cyclic pitch		0.5			
11d	Tail rotor pedal		0.5			
11e	Controllable stabilator		0.5			
11f	Hydraulic selection	Discrete(s)	1	-	-	

12	Hydraulics low pressure	Discrete(s)	1	-	-	Each essential system should be recorded.
13	Outside air temperature	-50° to +90°C Or available sensor range	2	± 2°C	0.3°C	
14	AFCS mode and engagement status	A suitable combination of discrettes	1	-	-	Discrettes should show which systems are engaged and which primary modes are controlling the flight path of the helicopter.
15	Stability augmentation system	Discrete	1	-	-	
16	Main gearbox oil pressure	As installed	1	As installed	6.895 kN/m <sup>2</sup> (1 psi)	
17	Main gearbox oil temperature	As installed	2	As installed	1°C	
18	Yaw rate	± 400 degrees/second	0.25	± 1 %	2 degrees per second	An equivalent yaw acceleration is an acceptable alternative.
19	Indicated sling load force	0 to 200 % of maximum certified load	0.5	± 3 % of maximum certified load	0.5 % for maximum certified	With reasonable practicability if sling load indicator is installed.
20	Longitudinal acceleration(body axis)	± 1 g	0.25	±1.5 % of range excluding a datum error of ±5 %	0.004 g	See comment to parameter 5.
21	Lateral acceleration	± 1 g	0.25	±1.5 % of range excluding a datum error of ±5 %	0.004 g	See comment to parameter 5.

22	Radio altitude	-20 ft to +2 500 ft	1	As installed. $\pm 2$ ft or $\pm 3$ % whichever is greater below 500 ft and $\pm 5$ % above 500 ft recommended	1 ft below 500 ft, 1 ft + 0.5 % of full range above 500 ft	
23	Vertical beam deviation		1	As installed $\pm 3$ % recommended	0.3 % of full range	Data from both the ILS and MLS systems need not to be recorded at the same time. The approach aid in use should be recorded.
23a	ILS glide path	$\pm 0.22$ DDM or available sensor range as installed				
23b	MLS elevation	+0.9 to +30 degrees				
24	Horizontal beam deviation		1	As installed. $\pm 3$ % recommended	0.3 % of full range	See comment to parameter 23
24a	ILS localiser	$\pm 0.22$ DDM or available sensor range				
24b	MLS azimuth	$\pm 62$ degrees				
25	Marker beacon passage	Discrete	1	-	-	One discrete is acceptable for all markers.

26	Warnings	DisCRETes	1	-	-	A discrete should be recorded for the master warning, gearbox low oil pressure and SAS failure. Other 'red' warnings should be recorded where the warning condition cannot be determined from other parameters or from the cockpit voice recorder.
27	Reserved					
28	Reserved					
29	Reserved					
30	Landing gear or gear selector position	Discrete(s)	4	-	-	Where installed.

Table 3: Helicopters equipped with electronic display systems

N°	Parameter	Range	Sampling interval in seconds	Accuracy Limits (sensor input compared to FDR read out)	Minimum Resolution in read out	Remarks
38	Selected barometric setting (each pilot station)	As installed	64	As installed	1 mb	Where practicable, a sampling interval of 4 seconds is recommended.
38a	Pilot					
38b	Co-pilot					

39	Selected altitude	As installed	1	As installed	100 ft	Where capacity is limited, a sampling interval of 64 seconds is permissible.
39a	Manual					
39b	Automatic					
40	Selected speed	As installed	1	As installed	1 kt	Where capacity is limited, a sampling interval of 64 seconds is permissible.
40a	Manual					
40b	Automatic					
41	Selected Mach	As installed	1	As installed	0.01	Where capacity is limited, a sampling interval of 64 seconds is permissible.
41a	Manual					
41b	Automatic					
42	Selected vertical speed	As installed	1	As installed	100 ft/min	Where capacity is limited, a sampling interval of 64 seconds is permissible
42a	Manual					
42b	Automatic					
43	Selected heading	360 degrees	1	As installed	100 ft /min	Where capacity is limited, a sampling interval of 64 seconds is permissible.
44	Selected flight path		1	As installed		



44a	Course/DSTRK				1 degree	
44b	Path angle				0.1 degree	
45	Selected decision height	0-500 ft	64	As installed	1ft	
46	EFIS display format	Discrete(s)	4	-	-	Discretes should show the display system status e.g. normal, fail, composite, sector, plan, rose, nav aids, wxr, range, copy
46a	Pilot					
46b	Co-pilot					
47	Multi-function/engine/alerts display format	Discrete(s)	4	-	-	Discretes should show the display system status, e.g. normal, fail, and the identity of the display pages for the emergency procedures and checklists. Information in checklists and procedures need not be recorded.

*The term ‘where practicable’ used in the remarks column of Table 3 means that account should be taken of the following:*

- a. if the sensor is already available or can be easily incorporated;
- b. sufficient capacity is available in the flight recorder system;
- c. for navigational data (nav frequency selection, DME distance, latitude, longitude, groundspeed and drift) the signals are available in digital form;
- d. the extent of modification required;
- e. the down- time period; and
- f. equipment software development.

### **GM1 CAT.IDE.H.190 Flight data recorder**

#### GENERAL

For the purpose of AMC2 CAT.IDE.H.190(b), a sensor is considered ‘readily available’ when it is already available or can be easily incorporated.

### **AMC1 CAT.IDE.H.195 Data link recording**

#### GENERAL

- (a) The helicopter should be capable of recording the messages as specified in this AMC.
- (b) As a means of compliance with CAT.IDE.H.195(a), the rec order on which the data link messages are recorded may be:
  - (1) the CVR;
  - (2) the FDR;
  - (3) a combination recorder when CAT.IDE.H.200 is applicable; or
  - (4) a dedicated flight recorder. In that case, the operational performance requirements for this recorder should be those laid down in EUROCAE Document ED- 112 (Minimum Operational Performance Specification for Crash Protected Airborne Recorder Systems) dated March 2003, including amendments No 1 and No 2, or any later equivalent standard produced by EUROCAE.
- (c) As a means of compliance with CAT.IDE.H.195(a)(2), the operator should enable correlation by providing information that allows an accident investigator to understand what data were provided to the helicopter and, when the provider identification is contained in the message, by which provider.
- (d) The timing information associated with the data link communications messages required to be recorded by CAT.IDE.H.195(a)(3) should be capable of being determined from the airborne-based recordings. This timing information should include at least the following:
  - (1) the time each message was generated;
  - (2) the time any message was available to be displayed by the crew;
  - (3) the time each message was actually displayed or recalled from a queue; and
  - (4) the time of each status change.
- (e) The message priority should be recorded when it is defined by the protocol of the data link communication message being recorded.
- (f) The expression ‘taking into account the system architecture’, in CAT.IDE.H.195(a)(3), means that the recording of the specified information may be omitted if the existing source systems involved would require a major upgrade. The following should be considered:
  - (1) the extent of the modification required;
  - (2) the down-time period; and
  - (3) equipment software development.
- (g) The intention is that new designs of source systems should include this functionality and support the full recording of the required information.

- (h) Data link communications messages that support the applications in Table 1 below should be recorded.
- (i) Further details on the recording requirements can be found in the recording requirement matrix in Appendix D.2 of EUROCAE Document ED- 93 (Minimum Aviation System Performance Specification for CNS/ATM Recorder Systems, dated November 1998).

Table 1: Applications

Item No	Application Type	Application Description	Required Recording Content
1	Data link initiation	This includes any application used to log on to, or initiate, a data link service. In future air navigation system (FANS)- 1/A and air traffic navigation (ATN), these are ATS facilities notification (AFN) and context management (CM), respectively.	C
2	Controller/pilot communication	This includes any application used to exchange requests, clearances, instructions and reports between the flight crew and air traffic controllers. In FANS-1/A and ATN, this includes the controller pilot data link communications (CPDLC) application. CPDLC includes the exchange of oceanic clearances (OCLs) and departure clearances (DCLs).	C
3	Addressed surveillance	This includes any surveillance application in which the ground sets up contracts for delivery of surveillance data. In FANS-1/A and ATN, this includes the automatic dependent surveillance-contract (ADS-C) application.	C, F2
4	Flight information	This includes any application used for delivery of flight information data to specific aeroplanes. This includes for example, data link- automatic terminal information service (D- ATIS), data link-operational terminal information service (D-OTIS), digital weather information services (D- METAR or TWIP), data link flight information service (D-FIS) and Notice to Airmen (D-NOTAM) delivery.	C
5	Aircraft broadcast surveillance	This includes elementary and enhanced surveillance systems, as well as automatic dependent surveillance-broadcast (ADS- B) output data.	M*, F2
6	Airlines operations centre (AOC) data	This includes any application transmitting or receiving data used for AOC purposes (in accordance with the ICAO definition of AOC). Such systems may also process AAC messages, but there is no requirement to record AAC messages	M*

7	Graphics	This includes any application receiving graphic al data to be used for operational purposes (i.e. excluding applications that are receiving such things as updates to manuals).	M* F1
---	----------	---	-------

## GM1 CAT.IDE.H.195 Data link recording

### DEFINITIONS AND ACRONYMS

- (a) The letters and expressions in Table 1 of AMC1 CAT.IDE.H.195 have the following meaning:

C: Complete contents recorded

*M: Information that enables correlation with any associated records stored separately from the helicopter.*

*\*: Applications that are to be recorded only as far as is practicable, given the architecture of the system.*

*F1: Graphics applications may be considered as AOC data when they are part of a data link communications application service run on an individual basis by the operator itself in the framework of the operational control.*

*F2: Where parametric data sent by the helicopter, such as Mode S, is reported within the message, it should be recorded unless data from the same source is recorded on the FDR.*

- (b) The definitions of the applications type in Table 1 of AMC1 CAT.IDE.H.195 are described in Table 1 below.

Table 1: Descriptions of the applications type

Item No	Application Type	Messages	Comments
1	CM		CM is an ATN service
2	AFN		AFN is a FANS 1/A service
3	CPDLC		All implemented up and downlink messages to be recorded
4	ADS-C	ADS-C reports	All contract requests and reports recorded
		Position reports	Only used within FANS 1/A. Only used in oceanic and remote areas.
5	ADS-B	Surveillance data	Information that enables correlation with any associated records stored separately from the helicopter.
6	D- FIS		D-FIS is an ATN service. All implemented up and downlink messages to be recorded
7	TWIP	TWIP messages	Terminal weather information for pilots

8	D- ATIS	ATIS messages	Refer to EUROCAE Document ED-89A dated December 2003. Data Link Application System Document (DLASD) for the 'ATIS' Data Link Service
9	OCL	OCL messages	Refer to EUROCAE Document ED-106A dated March 2004. Data Link Application System Document (DLASD) for 'Oceanic Clearance' Data Link Service
10	DCL	DCL messages	Refer to EUROCAE Document ED-85A dated December 2003. Data Link Application System Document (DLASD) for 'Departure Clearance' Data Link Service
11	Graphics	Weather maps & other graphics	Graphics exchanged in the framework of procedures within the operational control, as specified in Part- ORO. Information that enables correlation with any associated records stored separately from the aeroplane.
12	AOC	Aeronautical operational control messages	Messages exchanged in the framework of procedures within the operational control, as specified in Part- ORO. Information that enables correlation with any associated records stored separately from the helicopter. Definition in EUROCAE Document ED-112, dated March 2003.
13	Surveillance	Downlinked aircraft parameters (DAP)	As defined in ICAO Annex 10 Volume IV (Surveillance systems and ACAS).

*AAC aeronautical administrative communications ADS- B automatic dependent surveillance — broadcast ADS-C automatic dependent surveillance — contract AFN aircraft flight notification*  
*AOC aeronautical operational control*  
*ATIS automatic terminal information service ATSC air traffic service communication*  
*CAP controller access parameters*  
*CPDLC controller pilot data link communications*  
*CM configuration/context management*  
*D- ATIS data link ATIS*  
*D- FIS data link flight information service DCL departure clearance*  
*FANS Future Air Navigation System*  
*FLIPCY flight plan consistency*  
*OCL oceanic clearance*  
*SAP system access parameters*  
*TWIP terminal weather information for pilots*

**GM1 CAT.IDE.H.195(a) Data link recording**

## APPLICABILITY OF THE DATA LINK RECORDING REQUIREMENT

- (a) If it is certain that the helicopter cannot use data link communication messages for ATS communications corresponding to any application designated by CAT.IDE.H.195(a)(1), then the data link recording requirement does not apply.
- (b) Examples where the helicopter cannot use data link communication messages for ATS communications include but are not limited to the cases where:
  - (1) the helicopter data link communication capability is disabled permanently and in a way that it cannot be enabled again during the flight;
  - (2) data link communications are not used to support air traffic service (ATS) in the area of operation of the helicopter; and
  - (3) the helicopter data link communication equipment cannot communicate with the equipment used by ATS in the area of operation of the helicopter.

**AMC1 CAT.IDE.H.200 Flight data and cockpit voice combination recorder**

## GENERAL

- (a) A flight data and cockpit voice combination recorder is a flight recorder that records:
  - (1) All voice communications and the aural environment required by CAT.IDE.H.185 regarding CVRs; and
  - (2) all parameters required by CAT.IDE.H.190 regarding FDRs, with the same specifications required by those paragraphs.
- (b) In addition, a flight data and cockpit voice combination recorder may record data link communication messages and related information required by CAT.IDE.H.195.

**AMC1 CAT.IDE.H.205 Seats, seat safety belts, restraint systems and child restraint devices**

## CHILD RESTRAINT DEVICES (CRDs)

- (a) A CRD is considered to be acceptable if:
  - (1) it is a 'supplementary loop belt' manufactured with the same techniques and the same materials of the approved safety belts; or
  - (2) it complies with (b).
- (b) Provided the CRD can be installed properly on the respective helicopter seat, the following CRDs are considered acceptable:
  - (1) CRDs approved for use in aircraft by a competent authority on the basis of a technical standard and marked accordingly;
  - (2) CRDs approved for use in motor vehicles according to the UN standard ECE R 44, -03 or later series of amendments;
  - (3) CRDs approved for use in motor vehicles and aircraft according to Canadian CMVSS 213/213.1;
  - (4) CRDs approved for use in motor vehicles and aircraft according to US FMVSS No 213 and are manufactured to these standards on or after February 26, 1985. US approved CRDs manufactured after this date must bear the following labels in red letters:
    - (i) 'THIS CHILD RESTRAINT SYSTEM CONFORMS TO ALL APPLICABLE FEDERAL MOTOR VEHICLE SAFETY STANDARDS'; and
    - (ii) 'THIS RESTRAINT IS CERTIFIED FOR USE IN MOTOR VEHICLES AND AIRCRAFT';
  - (5) CRDs qualified for use in aircraft according to the German 'Qualification Procedure for Child Restraint Systems for Use in Aircraft' (TÜV Doc.:TÜV/958-01/2001); and

- (6) devices approved for use in cars, manufactured and tested to standards equivalent to those listed above. The device should be marked with an associated qualification sign, which shows the name of the qualification organisation and a specific identification number, related to the associated qualification project. The qualifying organisation should be a competent and independent organisation that is acceptable to the competent authority.
- (c) Location
- (1) Forward-facing CRDs may be installed on both forward-and rearward-facing passenger seats, but only when fitted in the same direction as the passenger seat on which they are positioned. Rearward-facing CRDs should only be installed on forward-facing passenger seats. A CRD should not be installed within the radius of action of an airbag unless it is obvious that the airbag is deactivated or it can be demonstrated that there is no negative impact from the airbag.
  - (2) An infant in a CRD should be located as near to a floor level exit as feasible.
  - (3) An infant in a CRD should not hinder evacuation for any passenger.
  - (4) An infant in a CRD should neither be located in the row (where rows are existing) leading to an emergency exit nor located in a row immediately forward or aft of an emergency exit. A window passenger seat is the preferred location. An aisle passenger seat or a cross aisle passenger seat that forms part of the evacuation route to exits is not recommended. Other locations may be acceptable provided the access of neighbour passengers to the nearest aisle is not obstructed by the CRD.
  - (5) In general, only one CRD per row segment is recommended. More than one CRD per row segment is allowed if the infants are from the same family or travelling group provided the infants are accompanied by a responsible adult sitting next to them.
  - (6) A row segment is the fraction of a row separated by two aisles or by one aisle and the helicopter fuselage.
- (d) Installation
- (1) CRDs should only be installed on a suitable helicopter seat with the type of connecting device they are approved or qualified for. For instance, CRDs to be connected by a three- point harness only (most rearward facing baby CRDs currently available) should not be attached to a helicopter seat with a lap belt only, a CRD designed to be attached to a vehicle seat by means of rigid bar lower anchorages (ISO-FIX or US equivalent) only, should only be used on helicopter seats that are equipped with such connecting devices and should not be attached by the helicopter seat lap belt. The method of connecting should be the one shown in the manufacturer's instructions provided with each CRD.
  - (2) All safety and installation instructions must be followed carefully by the responsible person accompanying the infant. Cabin crew should prohibit the use of any inadequately installed CRD or not qualified seat.
  - (3) If a forward- facing CRD with a rigid backrest is to be fastened by a lap belt, the restraint device should be fastened when the backrest of the passenger seat on which it rests is in a reclined position. Thereafter, the backrest is to be positioned upright. This procedure ensures better tightening of the CRD on the aircraft seat if the aircraft seat is reclinable.
  - (4) The buckle of the adult safety belt must be easily accessible for both opening and closing, and must be in line with the seat belt halves (not canted) after tightening.
  - (5) Forward facing restraint devices with an integral harness must not be installed such that the adult safety belt is secured over the infant.
- (e) Operation

- (1) Each CRD should remain secured to a passenger seat during all phases of flight unless it is properly stowed when not in use.
- (2) Where a CRD is adjustable in recline, it must be in an upright position for all occasions when passenger restraint devices are required.

### **AMC2 CAT.IDE.H.205 Seats, seat safety belts, restraint systems and child restraint devices**

#### UPPER TORSO RESTRAINT SYSTEM

- (a) A restraint system including a seat belt, two shoulder straps and additional straps is deemed to be compliant with the requirement for restraint systems with two shoulder straps.
- (b) An upper torso restraint system which restrains permanently the torso of the occupant is deemed to be compliant with the requirement for an upper torso restraint system incorporating a device that will automatically restrain the occupant's torso in the event of rapid deceleration.
- (c) The use of the upper torso restraint independently from the use of the seat belt is intended as an option for the comfort of the occupant of the seat in those phases of flight where only the seat belt is required to be fastened. A restraint system including a seat belt and an upper torso restraint that both remain permanently fastened is also acceptable.

#### SEAT BELT

- (d) A seat belt with a diagonal shoulder strap (three anchorage points) is deemed to be compliant with the requirement for a seat belt (two anchorage points).

### **AMC3 CAT.IDE.H.205 Seats, seat safety belts, restraint systems and child restraint devices**

#### SEATS FOR MINIMUM REQUIRED CABIN CREW

- (a) Seats for the minimum required cabin crew members should be located near required floor level emergency exits, except if the emergency evacuation of passengers would be enhanced by seating the cabin crew members elsewhere. In this case, other locations are acceptable. This criterion should also apply if the number of required cabin crew members exceeds the number of floor level emergency exits.
- (b) Seats for cabin crew member(s) should be forward or rearward facing within 15° of the longitudinal axis of the helicopter.

### **GM1 CAT.IDE.A.205 Seats, seat safety belts, restraint systems and child restraint devices**

#### EMERGENCY LANDING DYNAMIC CONDITIONS

Emergency landing dynamic conditions are defined in 23.562 of CS-23 or equivalent and in 25.562 of CS-25 or equivalent

### **AMC1 CAT.IDE.H.220 First-aid kits**

#### CONTENT OF FIRST-AID KITS

- (a) First-aid kits should be equipped with appropriate and sufficient medications and instrumentation. However, these kits should be complemented by the operator according to the characteristics of the operation (scope of operation, flight duration, number and demographics of passengers, etc.).
- (b) The following should be included in the first-aid kit:
  - (1) Equipment
    - (i) bandages (assorted sizes);
    - (ii) burns dressings (unspecified);
    - (iii) wound dressings (large and small);



- (iv) adhesive dressings (assorted sizes);
  - (v) adhesive tape;
  - (vi) adhesive wound closures;
  - (vii) safety pins;
  - (viii) safety scissors;
  - (ix) antiseptic wound cleaner;
  - (x) disposable resuscitation aid;
  - (xi) disposable gloves;
  - (xii) tweezers: splinter; and
  - (xiii) thermometers (non-mercury).
- (2) Medications
- (i) simple analgesic (may include liquid form);
  - (ii) antiemetic ;
  - (iii) nasal decongestant;
  - (iv) gastrointestinal antacid, in the case of helicopters carrying more than 9 passengers;
  - (v) anti- diarrhoeal medication in the case of helicopters carrying more than 9 passengers; and
  - (vi) antihistamine.
- (3) Other
- (i) a list of contents in at least two languages (English and one other). This should include information on the effects and side effects of medications carried;
  - (ii) first-aid handbook, current edition;
  - (iii) medic al incident report form;
  - (iv) biohazard disposal bags.
- (4) An eye irrigator, whilst not required to be carried in the first-aid kit, should, where possible, be available for use on the ground.

### **AMC2 CAT.IDE.H.220 First-aid kits**

#### MAINTENANCE OF FIRST- AID KITS

To be kept up to date, first-aid kits should be:

- (a) inspected periodic ally to confirm, to the extent possible, that contents are maintained in the condition necessary for their intended use;
- (b) replenished at regular intervals, in accordance with instructions contained on their labels, or as circumstances warrant; and
- (c) replenished after use-in-flight at the first opportunity where replacement items are available.

### **AMC1 CAT.IDE.H.240 Supplemental oxygen — non-pressurised helicopters**

#### DETERMINATION OF OXYGEN

The amount of supplemental oxygen for sustenance for a particular operation should be determined on the basis of flight altitudes and flight duration, consistent with the operating procedures, including emergency, procedures, established for each operation and the routes to be flown as specified in the operations manual.

### **AMC1 CAT.IDE.H.250 Hand fire extinguishers**

#### NUMBER, LOCATION AND TYPE

- (a) The number and location of hand fire extinguishers should be such as to provide adequate availability for use, account being taken of the number and size of the passenger compartments, the need to minimise the hazard of toxic gas concentrations and the location of lavatories, galleys, etc. These considerations may result in a number of fire extinguishers greater than the minimum required.
- (b) There should be at least one hand fire extinguisher installed in the flight crew compartment and this should be suitable for fighting both flammable fluid and electrical equipment fires. Additional hand fire extinguishers may be required for the protection of other compartments accessible to the crew in flight. Dry chemical fire extinguishers should not be used in the flight crew compartment, or in any compartment not separated by a partition from the flight crew compartment, because of the adverse effect on vision during discharge and, if conductive, interference with electrical contacts by the chemical residues.
- (c) Where only one hand fire extinguisher is required in the passenger compartments, it should be located near the cabin crew member's station, where provided.
- (d) Where two or more hand fire extinguishers are required in the passenger compartments and their location is not otherwise dictated by consideration of (a), an extinguisher should be located near each end of the cabin with the remainder distributed throughout the cabin as evenly as is practicable.
- (e) Unless an extinguisher is clearly visible, its location should be indicated by a placard or sign. Appropriate symbols may also be used to supplement such a placard or sign.

### **AMC1 CAT.IDE.H.260 Marking of break-in points**

#### MARKINGS — COLOUR AND CORNERS

- (a) The colour of the markings should be red or yellow and, if necessary, should be outlined in white to contrast with the background.
- (b) If the corner markings are more than 2 m apart, intermediate lines 9 cm x 3 cm should be inserted so that there is no more than 2 m between adjacent markings.

### **AMC1 CAT.IDE.H.270 Megaphones**

#### LOCATION OF MEGAPHONES

- (a) The megaphone should be readily accessible at the assigned seat of a cabin crew member or crew members other than flight crew.
- (b) This does not necessarily require megaphones to be positioned such that they can be physically reached by a crew member when strapped in a cabin crew member's seat.

### **AMC1 CAT.IDE.H.280 Emergency locator transmitter (ELT)**

#### BATTERIES

- (a) All batteries used in ELTs should be replaced (or recharged if the battery is rechargeable) when the equipment has been in use for more than 1 cumulative hour or in the following cases:
  - (1) Batteries specifically designed for use in ELTs and having an airworthiness release certificate (EASA Form 1 or equivalent) should be replaced (or recharged if the battery is rechargeable) before the end of their useful life in accordance with the maintenance instructions applicable to the ELT.
  - (2) Standard batteries manufactured in accordance with an industry standard and not having an airworthiness release certificate (EASA Form 1 or equivalent), when used in ELTs should be replaced (or recharged if the battery is rechargeable) when 50 % of their useful life (or for rechargeable, 50 % of their useful life of charge), as established by the battery manufacturer, has expired.
  - (3) The battery useful life (or useful life of charge) criteria in (1) and (2) do not apply to batteries (such as water-activated batteries) that are essentially unaffected during probable storage intervals.

- (b) The new expiry date for a replaced (or recharged) battery should be legibly marked on the outside of the equipment.

## **AMC2 CAT.IDE.H.280 Emergency locator transmitter (ELT)**

### TYPES OF ELT AND GENERAL TECHNICAL SPECIFICATIONS

- (a) The ELT required by this provision should be one of the following:
- (1) Automatic Fixed (ELT(AF)). An automatic ally activated ELT that is permanently attached to an aircraft and is designed to aid search and rescue (SAR) teams in locating the crash site.
  - (2) Automatic Portable (ELT(AP)). An automatic ally activated ELT, which is rigidly attached to an aircraft before a c rash, but is readily removable from the aircraft after a c rash. It functions as an ELT during the crash sequence. If the ELT does not employ an integral antenna, the aircraft- mounted antenna may be disconnected and an auxiliary antenna (stored in the ELT case) attached to the ELT. The ELT can be tethered to a survivor or a life- raft. This type of ELT is intended to aid SAR teams in locating the crash site or survivor(s).
  - (3) Automatic Deployable (ELT(AD)). An ELT that is rigidly attached to the aircraft before the crash and that is automatically ejected, deployed and activated by an impact, and, in some cases, also by hydrostatic sensors. Manual deployment is also provided. This type of ELT should float in water and is intended to aid SAR teams in locating the crash site.
  - (4) Survival ELT (ELT(S)). An ELT that is removable from an aircraft, stowed so as to facilitate its ready use in an emergency, and manually activated by a survivor. An ELT(S) may be activated manually or automatically (e.g. by water activation). It should be designed either to be tethered to a life- raft or a survivor.
- (b) To minimise the possibility of damage in the event of crash impact, the automatic ELT should be rigidly fixed to the aircraft structure, as far aft as is practicable, with its antenna and connections arranged so as to maximise the probability of the signal being transmitted after a c rash.
- (c) Any ELT carried should operate in accordance with the relevant provisions of ICAO Annex 10, Volume III Communications Systems and should be registered with the national agency responsible for initiating search and rescue or other nominated agency.

## **GM1 CAT.IDE.H.280 Emergency locator transmitter (ELT)**

### TERMINOLOGY

‘ELT’ is a generic term describing equipment that broadcasts distinctive signals on designated frequencies and, depending on application, may be activated by impact or may be manually activated.

## **AMC1 CAT.IDE.H.290 Life-jackets**

### ACCESSIBILITY

The life-jacket should be accessible from the seat or berth of the person for whose use it is provided, with a safety belt or harness fastened.

## **AMC2 CAT.IDE.H.290 Life-jackets**

### ELECTRIC ILLUMINATION

The means of electric illumination should be a survivor locator light as defined in the applicable ETSO issued by the Libyan CAA.

## **GM1 CAT.IDE.H.290 Life-jackets**

### SEAT CUSHIONS

Seat cushions are not considered to be flotation devices.

**GM1 CAT.IDE.H.295 Crew survival suits**

## ESTIMATING SURVIVAL TIME

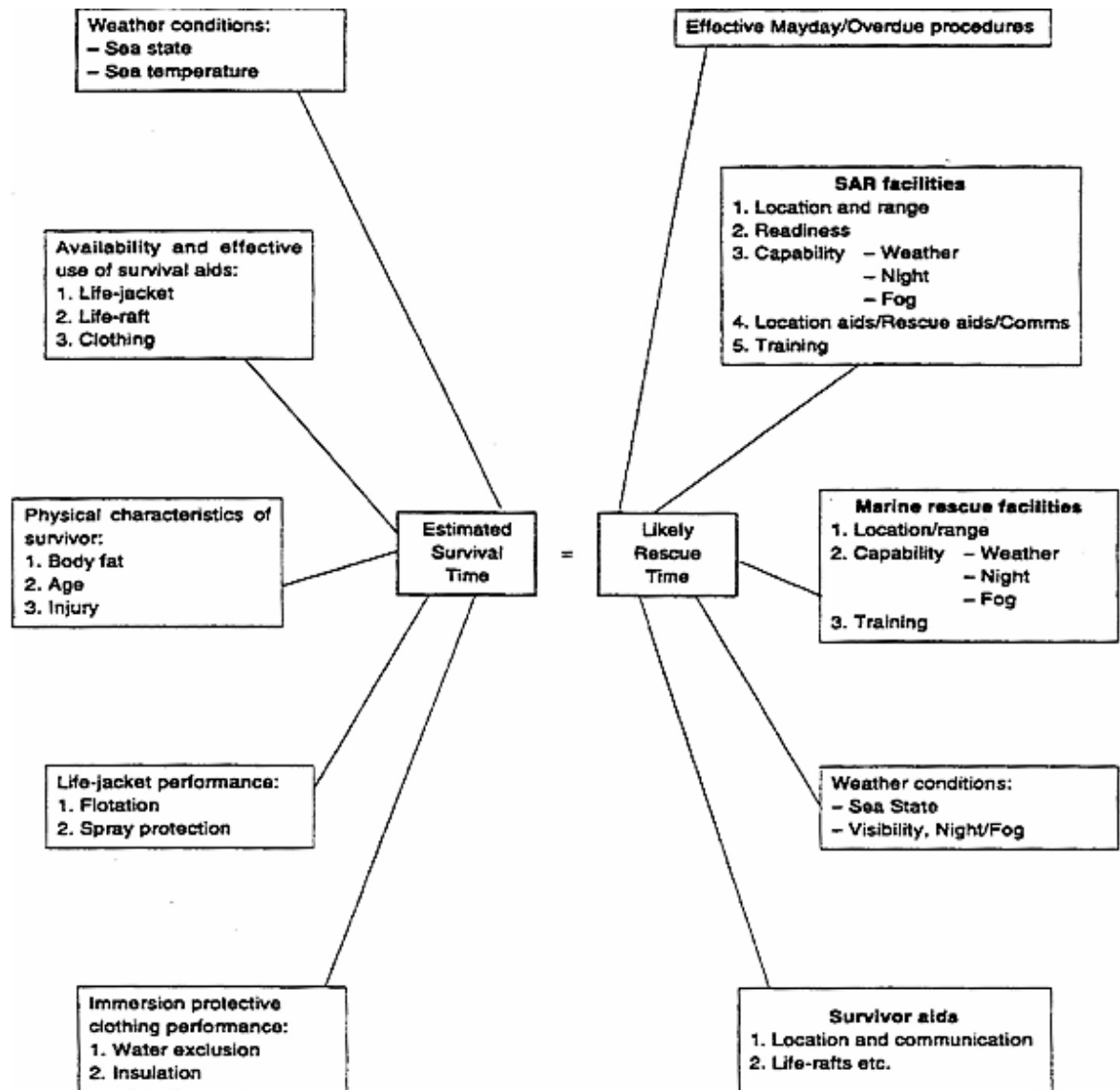
## (a) Introduction

- (1) A person accidentally immersed in cold seas (typically offshore Northern Europe) will have a better chance of survival if he/she is wearing an effective survival suit in addition to a life- jacket. By wearing the survival suit, he/she can slow down the rate which his/her body temperature falls and, consequently, protect himself/herself from the greater risk of drowning brought about by incapacitation due to hypothermia.
- (2) The complete survival suit system – suit, life- jacket and clothes worn under the suit – should be able to keep the wearer alive long enough for the rescue services to find and recover him/her. In practice the limit is about 3 hours. If a group of persons in the water cannot be rescued within this time they are likely to have become so scattered and separated that location will be extremely difficult, especially in the rough water typical of Northern European sea areas. If it is expected that in water protection could be required for periods greater than 3 hours, improvements should, rather, be sought in the search and rescue procedures than in the immersion suit protection.

## (b) Survival times

- (1) The aim should be to ensure that a person in the water can survive long enough to be rescued, i.e. the survival time must be greater than the likely rescue time. The factors affecting both times are shown in Figure 1 below. The figure emphasises that survival time is influenced by many factors, physical and human. Some of the factors are relevant to survival in cold water and some are relevant to survival in water at any temperature.

Figure 1: The survival equation



- (2) Broad estimates of likely survival times for the thin individual offshore are given in Table 1 below. As survival time is significantly affected by the prevailing weather conditions at the time of immersion, the Beaufort wind scale has been used as an indicator of these surface conditions.

Table 1: Timescale within which the most vulnerable individuals are likely to succumb to the prevailing conditions.

Clothing assembly	Beaufort wind force	Times within which the most vulnerable individuals are likely to drown	
		(watertemp 5°C)	(watertemp 13°C)
Working clothes (no immersion suit)	0 – 2	Within ¾ hour	Within 1 ¼ hours
	3 – 4	Within ½ hour	Within ½ hour
	5 and above	Significantly less than ½ hour	Significantly less than ½ hour
Immersion suit worn over working clothes (with leakage inside suit)	0 - 2	May well exceed 3 hours	May well exceed 3 hours
	3 – 4	Within 2 ¾ hours	May well exceed 3 hours
	5 and above	Significantly less than 2 ¾ hours. May well exceed 1 hour	May well exceed 3 hours

- (3) Consideration should also be given to escaping from the helicopter itself should it submerge or invert in the water. In this case, escape time is limited to the length of time the occupants can hold their breath. The breath holding time can be greatly reduced by the effect of cold shock. Cold shock is caused by the sudden drop in skin temperature on immersion, and is characterised by a gasp reflex and uncontrolled breathing. The urge to breathe rapidly becomes overwhelming and, if still submerged, the individual will inhale water resulting in drowning. Delaying the onset of cold shock by wearing an immersion suit will extend the available escape time from a submerged helicopter.
- (4) The effects of water leakage and hydrostatic compression on the insulation quality of clothing are well recognised. In a nominally dry system, the insulation is provided by still air trapped within the clothing fibres and between the layers of suit and clothes. It has been observed that many systems lose some of their insulative capacity either because the clothes under the 'waterproof' survival suit get wet to some extent or because of hydrostatic compression of the whole assembly. As a result of water leakage and compression, survival times will be shortened. The wearing of warm clothing under the suit is recommended.
- (5) Whatever type of survival suit and other clothing is provided, it should not be forgotten that significant heat loss can occur from the head.

## **AMC1 CAT.IDE.H.300 Life-rafts, survival ELTs and survival equipment on extended overwater flights**

### LIFE–RAFTS AND EQUIPMENT FOR MAKING DISTRESS SIGNALS - HELICOPTERS

- (a) Each required life-raft should conform to the following specifications:
- (1) be of an approved design and stowed so as to facilitate their ready use in an emergency;
  - (2) be radar conspicuous to standard airborne radar equipment;
  - (3) when carrying more than one life-raft on board, at least 50 % should be able to be deployed by the crew while seated at their normal station, where necessary by remote control; and
  - (4) life-rafts that are not deployable by remote control or by the crew should be of such weight as to permit handling by one person. 40 kg should be considered a maximum weight.
- (b) Each required life-raft should contain at least the following:
- (1) one approved survivor locator light;
  - (2) one approved visual signalling device;
  - (3) one canopy (for use as a sail, sunshade or rain catcher) or other mean to protect occupants from the elements;
  - (4) one radar reflector;
  - (5) one 20- m retaining line designed to hold the life-raft near the helicopter but to release it if the helicopter becomes totally submerged;
  - (6) one sea anchor;
  - (7) one survival kit, appropriately equipped for the route to be flown, which should contain at least the following:
    - (i) one life-raft repair kit;
    - (ii) one bailing bucket;
    - (iii) one signalling mirror;
    - (iv) one police whistle;
    - (v) one buoyant raft knife;
    - (vi) one supplementary means of inflation;
    - (vii) sea sickness tablets;
    - (viii) one first-aid kit;
    - (ix) one portable means of illumination;
    - (x) 500 ml of pure water and one sea water desalting kit; and
    - (xi) one comprehensive illustrated survival booklet in an appropriate language.

## **AMC1 CAT.IDE.H.300(b)(3) & CAT.IDE.H.305(b) Flight over water & Survival equipment**

### SURVIVAL ELT

An ELT(AP) may be used to replace one required ELT(S) provided that it meets the ELT(S) requirements. A water-activated ELT(S) is not an ELT(AP).

## **AMC1 CAT.IDE.H.305 Survival equipment**

### ADDITIONAL SURVIVAL EQUIPMENT

- (a) The following additional survival equipment should be carried when required:
- (1) 500 ml of water for each 4, or fraction of 4, persons on board;
  - (2) one knife;
  - (3) first-aid equipment; and

- (4) one set of air/ground codes.
- (b) In addition, when polar conditions are expected, the following should be carried:
  - (1) a means for melting snow;
  - (2) one snow shovel and 1 ice saw;
  - (3) sleeping bags for use by 1/3 of all persons on board and space blankets for the remainder or space blankets for all passengers on board; and
  - (4) one arctic/polar suit for each crew member.
- (c) If any item of equipment contained in the above list is already carried on board the helicopter in accordance with another requirement, there is no need for this to be duplicated.

### **GM1 CAT.IDE.H.305 Survival equipment**

#### SIGNALLING EQUIPMENT

The signalling equipment for making distress signals is described in ICAO Annex 2, Rules of the Air.

### **GM2 CAT.IDE.H.305 Survival equipment**

#### AREAS IN WHICH SEARCH AND RESCUE WOULD BE ESPECIALLY DIFFICULT

The expression 'areas in which search and rescue would be especially difficult' should be interpreted, in this context, as meaning:

- (a) areas so designated by the authority responsible for managing search and rescue; or
- (b) areas that are largely uninhabited and where:
  - (1) the authority referred to in (a) has not published any information to confirm whether search and rescue would be or would not be especially difficult; and
  - (2) the authority referred to in (a) does not, as a matter of policy, designate areas as being especially difficult for search and rescue.

### **AMC1 CAT.IDE.H.310 Additional requirements for helicopters operating to or from helidecks located in a hostile sea area**

#### INSTALLATION OF THE LIFE- RAFT

- (a) Projections on the exterior surface of the helicopter, that are located in a zone delineated by boundaries that are 1.22 m (4 ft) above and 0.61 m (2 ft) below the established static water line could cause damage to a deployed life- raft. Examples of projections that need to be considered are aerials, overboard vents, unprotected split-pin tails, guttering and any projection sharper than a three dimensional right angled corner.
- (b) While the boundaries specified in (a) are intended as a guide, the total area that should be considered should also take into account the likely behaviour of the life-raft after deployment in all sea states up to the maximum in which the helicopter is capable of remaining upright.
- (c) Wherever a modification or alteration is made to a helicopter within the boundaries specified, the need to prevent the modification or alteration from causing damage to a deployed life- raft should be taken into account in the design.
- (d) Particular care should also be taken during routine maintenance to ensure that additional hazards are not introduced by, for example, leaving inspection panels with sharp corners proud of the surrounding fuselage surface, or allowing door sills to deteriorate to a point where sharp edges become a hazard.

### **GM1 CAT.IDE.H.315 Helicopters certificated for operating on water — Miscellaneous equipment**

#### INTERNATIONAL REGULATIONS FOR PREVENTING COLLISIONS AT SEA

International Regulations for Preventing Collisions at Sea are those that were published by the International Maritime Organisation (IMO) in 1972.



**AMC1 CAT.IDE.H.320(b) All helicopters on flight over water — ditching**

## GENERAL

The same considerations of AMC1 CAT.IDE.H.310 should apply in respect of emergency flotation equipment.

**AMC1 CAT.IDE.H.325 Headset**

## GENERAL

- (a) A headset consists of a communication device that includes two earphones to receive and a microphone to transmit audio signals to the helicopter's communication system. To comply with the minimum performance requirements, the earphones and microphone should match the communication system's characteristics and the cockpit environment. The headset should be adequately adjustable in order to fit the pilot's head. Headset boom microphones should be of the noise cancelling type.
- (b) If the intention is to utilise noise cancelling earphones, the operator should ensure that the earphones do not attenuate any aural warnings or sounds necessary for alerting the flight crew on matters related to the safe operation of the helicopter.

**GM1 CAT.IDE.H.325 Headset**

## GENERAL

The term 'headset' includes any aviation helmet incorporating headphones and microphone worn by a flight crew member.

**AMC1 CAT.IDE.H.345 Communication and navigation equipment for operations under IFR or under VFR over routes not navigated by reference to visual landmarks**

## TWO INDEPENDENT MEANS OF COMMUNICATION

Whenever two independent means of communication are required, each system should have an independent antenna installation, except where rigidly supported non-wire antennae or other antenna installations of equivalent reliability are used.

**AMC2 CAT.IDE.H.345 Communication and navigation equipment for operations under IFR or under VFR over routes not navigated by reference to visual landmarks**

## ACCEPTABLE NUMBER AND TYPE OF COMMUNICATION AND NAVIGATION EQUIPMENT

- (a) An acceptable number and type of communication and navigation equipment is:
  - (1) two VHF omnidirectional radio range (VOR) receiving systems on any route, or part thereof, where navigation is based only on VOR signals;
  - (2) two automatic direction finder (ADF) systems on any route, or part thereof, where navigation is based only on non-directional beacon (NDB) signals; and
  - (3) area navigation equipment when area navigation is required for the route being flown (e.g. equipment required by Part- SPA).
- (b) The helicopter may be operated without the navigation equipment specified in (a)(1) and (a)(2) provided it is equipped with alternative equipment. The reliability and the accuracy of alternative equipment should allow safe navigation for the intended route.
- (c) VHF communication equipment, instrument landing system (ILS) localiser and VOR receivers installed on helicopters to be operated under IFR should comply with the following FM immunity performance standards:
  - (1) ICAO Annex 10, Volume I - Radio Navigation Aids, and Volume III, Part II -
  - (2) Voice Communications Systems; and

- (3) acceptable equipment standards contained in EUROCAE Minimum Operational Performance Specifications, documents ED- 22B for VOR receivers, ED- 23B for VHF communication receivers and ED- 46B for LOC receivers and the corresponding Radio Technical Commission for Aeronautics (RTCA) documents DO-186, DO-195 and DO-196.

### **AMC3 CAT.IDE.H.345 Communication and navigation equipment for operations under IFR or under VFR over routes not navigated by reference to visual landmarks**

#### FAILURE OF A SINGLE UNIT

Required communication and navigation equipment should be installed such that the failure of any single unit required for either communication or navigation purposes, or both, will not result in the failure of another unit required for communications or navigation purposes.

### **GM1 CAT.IDE.H.345 Communication and navigation equipment for operations under IFR or under VFR over routes not navigated by reference to visual landmarks**

#### APPLICABLE AIRSPACE REQUIREMENTS

For helicopters being operated under European air traffic control, the applicable airspace requirements include the Single European Sky legislation.

### **GM2 CAT.IDE.A.345 Communication and navigation equipment for operations under IFR or under VFR over routes not navigated by reference to visual landmarks**

#### AIRCRAFT ELIGIBILITY FOR PBN SPECIFICATION NOT REQUIRING SPECIFIC APPROVAL

- (a) The performance of the aircraft is usually stated in the AFM.
- (b) Where such a reference cannot be found in the AFM, other information provided by the aircraft manufacturer as TC holder, the STC holder or the design organisation having a privilege to approve minor changes may be considered.
- (c) The following documents are considered acceptable sources of information:
  - (1) AFM, supplements thereto, and documents directly referenced in the AFM;
  - (2) FCOM or similar document;
  - (3) Service Bulletin or Service Letter issued by the TC holder or STC holder;
  - (4) approved design data or data issued in support of a design change approval;
  - (5) any other formal document issued by the TC or STC holders stating compliance with PBN specifications, AMC, Advisory Circulars (AC) or similar documents issued by the State of Design; and
  - (6) written evidence obtained from the State of Design.
- (d) Equipment qualification data, in itself, is not sufficient to assess the PBN capabilities of the aircraft, since the latter depend on installation and integration.
- (e) As some PBN equipment and installations may have been certified prior to the publication of the PBN Manual and the adoption of its terminology for the navigation specifications, it is not always possible to find a clear statement of aircraft PBN capability in the AFM. However, aircraft eligibility for certain PBN specifications can rely on the aircraft performance certified for PBN procedures and routes prior to the publication of the PBN Manual.
- (f) Below, various references are listed which may be found in the AFM or other acceptable documents (see listing above) in order to consider the aircraft's eligibility for a specific PBN specification if the specific term is not used.
- (g) RNAV 5

- (1) If a statement of compliance with any of the following specifications or standards is found in the acceptable documentation as listed above, the aircraft is eligible for RNAV 5 operations.
  - (i) B-RNAV;
  - (ii) RNAV 1;
  - (iii) RNP APCH;
  - (iv) RNP 4;
  - (v) A-RNP;
  - (vi) AMC 20-4;
  - (vii) JAA TEMPORARY GUIDANCE MATERIAL, LEAFLET NO. 2 (TGL 2);
  - (viii) JAA AMJ 20X2;
  - (ix) FAA AC 20-130A for en route operations;
  - (x) FAA AC 20-138 for en route operations; and
  - (xi) FAA AC 90-96.
- (h) RNAV 1/RNAV 2
  - (1) If a statement of compliance with any of the following specifications or standards is found in the acceptable documentation as listed above, the aircraft is eligible for RNAV 1/RNAV 2 operations.
    - (i) RNAV 1;
    - (ii) PRNAV;
    - (iii) US RNAV type A;
    - (iv) FAA AC 20-138 for the appropriate navigation specification;
    - (v) FAA AC 90-100A;
    - (vi) JAA TEMPORARY GUIDANCE MATERIAL, LEAFLET NO. 10 Rev1 (TGL 10); and
    - (vii) FAA AC 90-100.
  - (i) However, if position determination is exclusively computed based on VOR-DME, the aircraft is not eligible for RNAV 1/RNAV 2 operations.
  - (j) RNP 1/RNP 2 continental
    - (1) If a statement of compliance with any of the following specifications or standards is found in the acceptable documentation as listed above, the aircraft is eligible for RNP 1/RNP 2 continental operations.
      - (i) A-RNP;
      - (ii) FAA AC 20-138 for the appropriate navigation specification; and
      - (iii) FAA AC 90-105.
    - (2) Alternatively, if a statement of compliance with any of the following specifications or standards is found in the acceptable documentation as listed above and position determination is primarily based on GNSS, the aircraft is eligible for RNP 1/RNP 2 continental operations. However, in these cases, loss of GNSS implies loss of RNP 1/RNP 2 capability.
      - (i) JAA TEMPORARY GUIDANCE MATERIAL, LEAFLET NO. 10 (TGL 10) (any revision); and
      - (ii) FAA AC 90-100.
  - (k) RNP APCH — LNAV minima

- 
- (1) If a statement of compliance with any of the following specifications or standards is found in the acceptable documentation as listed above, the aircraft is eligible for RNP APCH — LNAV operations
    - (i) A-RNP;
    - (ii) AMC 20-27;
    - (iii) AMC 20-28;
    - (iv) FAA AC 20-138 for the appropriate navigation specification; and
    - (v) FAA AC 90-105 for the appropriate navigation specification.
  - (2) Alternatively, if a statement of compliance with RNP 0.3 GNSS approaches in accordance with any of the following specifications or standards is found in the acceptable documentation as listed above, the aircraft is eligible for RNP APCH — LNAV operations. Any limitation such as ‘within the US National Airspace’ may be ignored since RNP APCH procedures are assumed to meet the same ICAO criteria around the world.
    - (i) JAA TEMPORARY GUIDANCE MATERIAL, LEAFLET NO. 3 (TGL 3);
    - (ii) AMC 20-4;
    - (iii) FAA AC 20-130A; and
    - (iv) FAA AC 20-138.
- (l) RNP APCH — LNAV/VNAV minima
- (1) If a statement of compliance with any of the following specifications or standards is found in the acceptable documentation as listed above, the aircraft is eligible for RNP APCH — LNAV/VNAV operations.
    - (i) A-RNP;
    - (ii) AMC 20-27 with Baro VNAV;
    - (iii) AMC 20-28;
    - (iv) FAA AC 20-138; and
    - (v) FAA AC 90-105 for the appropriate navigation specification.
  - (2) Alternatively, if a statement of compliance with FAA AC 20-129 is found in the acceptable documentation as listed above, and the aircraft complies with the requirements and limitations of EASA SIB 2014-04<sup>1</sup>, the aircraft is eligible for RNP APCH — LNAV/VNAV operations. Any limitation such as ‘within the US National Airspace’ may be ignored since RNP APCH procedures are assumed to meet the same ICAO criteria around the world.
- (m) RNP APCH — LPV minima
- (1) If a statement of compliance with any of the following specifications or standards is found in the acceptable documentation as listed above, the aircraft is eligible for RNP APCH — LPV operations.
    - (i) AMC 20-28;
    - (ii) FAA AC 20-138 for the appropriate navigation specification; and
    - (iii) FAA AC 90-107
  - (2) For aircraft that have a TAWS Class A installed and do not provide Mode-5 protection on an LPV approach, the DH is limited to 250 ft.
- (n) RNAV 10
- (1) If a statement of compliance with any of the following specifications or standards is found in the acceptable documentation as listed above, the aircraft is eligible for RNAV 10 operations.
    - (i) RNP 10;
    - (ii) FAA AC 20-138 for the appropriate navigation specification; (iii) AMC 20-12;
-

- (iii) FAA Order 8400.12 (or later revision); and
  - (iv) FAA AC 90-105.
- (o) RNP 4
  - (1) If a statement of compliance with any of the following specifications or standards is found in the acceptable documentation as listed above, the aircraft is eligible for RNP 4 operations.
    - (i) FAA AC 20-138B or later, for the appropriate navigation specification;
    - (ii) FAA Order 8400.33; and
    - (iii) FAA AC 90-105 for the appropriate navigation specification.
- (p) RNP 2 oceanic
  - (1) If a statement of compliance with FAA AC 90-105 for the appropriate navigation specification is found in the acceptable documentation as listed above, the aircraft is eligible for RNP 2 oceanic operations.
  - (2) If the aircraft has been assessed eligible for RNP 4, the aircraft is eligible for RNP 2 oceanic.
- (q) Special features
  - (1) RF in terminal operations (used in RNP 1 and in the initial segment of the RNP APCH)
    - (i) If a statement of demonstrated capability to perform an RF leg, certified in accordance with any of the following specifications or standards, is found in the acceptable documentation as listed above, the aircraft is eligible for RF in terminal operations:
      - (A) AMC 20-26; and
      - (B) FAA AC 20-138B or later.
    - (ii) If there is a reference to RF and a reference to compliance with AC 90-105, then the aircraft is eligible for such operations.
- (r) Other considerations
  - (1) In all cases, the limitations in the AFM need to be checked; in particular, the use of AP or FD which can be required to reduce the FTE primarily for RNP APCH, RNAV 1, and RNP 1.
  - (2) Any limitation such as ‘within the US National Airspace’ may be ignored since RNP APCH procedures are assumed to meet the same ICAO criteria around the world.

### **GM3 CAT.IDE.A.345 Communication and navigation equipment for operations under IFR or under VFR over routes not navigated by reference to visual landmarks**

#### GENERAL

- (a) The PBN specifications for which the aircraft complies with the relevant airworthiness criteria are set out in the AFM, together with any limitations to be observed.
- (b) Because functional and performance requirements are defined for each navigation specification, an aircraft approved for an RNP specification is not automatically approved for all RNAV specifications. Similarly, an aircraft approved for an RNP or RNAV specification having a stringent accuracy requirement (e.g. RNP 0.3 specification) is not automatically approved for a navigation specification having a less stringent accuracy requirement (e.g. RNP 4).

#### RNP 4

- (c) For RNP 4, at least two LRNSs, capable of navigating to RNP 4, and listed in the AFM, may be operational at the entry point of the RNP 4 airspace. If an item of equipment required for RNP 4 operations is unserviceable, then the flight crew may consider an alternate route or diversion for repairs. For multi-sensor systems, the AFM may permit entry if one GNSS sensor is lost after departure, provided one GNSS and one inertial sensor remain available.

### **AMC1 CAT.IDE.H.350 Transponder**

#### SSR TRANSPONDER

- (a) The secondary surveillance radar (SSR) transponders of aircraft being operated under European air traffic control should comply with any applicable Single European Sky legislation.
- (b) If the Single European Sky legislation is not applicable, the SSR transponders should operate in accordance with the relevant provisions of Volume IV of ICAO Annex 10.

## **SECTION 3 —Sailplanes**

Reserved

## **SECTION 4 — Balloons**

Reserved